



Figure can vary

Part no.: 68001227
MLC510R20-2700
Safety light curtain receiver



Contents

- Technical data
- Suitable transmitters
- Dimensioned drawings
- Electrical connection
- Circuit diagrams
- Operation and display
- Part number code
- Accessories
- Notes

Technical data

Basic data	
Series	MLC 500
Device type	Receiver
Contains	2x BT-NC sliding block
Application	Hand protection
Functions	
Function package	Basic
Functions	Transmission channel changeover Automatic start/restart
Characteristic parameters	
Type	4, IEC/EN 61496
SIL	3, IEC 61508
SILCL	3, IEC/EN 62061
Performance Level (PL)	e, EN ISO 13849-1
PFH _D	7.73E-09 per hour
Mission time T _M	20 years, EN ISO 13849-1
Category	4, EN ISO 13849
Protective field data	
Resolution	20 mm
Protective field height	2,700 mm
Optical data	
Synchronization	Optical between transmitter and receiver
Electrical data	
Protective circuit	Overvoltage protection Short circuit protected
Performance data	
Supply voltage	24 V, DC, -20 ... 20 %
Current consumption, max.	150 mA
Fuse	2 A semi time-lag

Outputs

Number of safety-related switching outputs (OSSDs) 2 Piece(s)

Safety-related switching outputs

Type	Safety-related switching output OSSD
Switching voltage high, min.	18 V
Switching voltage low, max.	2.5 V
Switching voltage, typ.	22.5 V
Voltage type	DC
Current load, max.	380 mA
Load inductivity	2,000 µH
Load capacity	0.3 µF
Residual current, max.	0.2 mA
Residual current, typ.	0.002 mA
Voltage drop	1.5 V

Safety-related switching output 1

Assignment	Connection 1, pin 2
Switching element	Transistor, PNP

Safety-related switching output 2

Assignment	Connection 1, pin 4
Switching element	Transistor, PNP

Timing

Response time	46 ms
Restart delay time	100 ms

Connection

Number of connections 1 Piece(s)

Connection 1

Type of connection	Connector
Function	Machine interface
Thread size	M12
Material	Metal
No. of pins	5 -pin

Cable properties

Permissible conductor cross section, typ.	0.25 mm ²
Length of connection cable, max.	100 m
Permissible cable resistance to load, max.	200 Ω

Mechanical data

Dimension (W x H x L)	29 mm x 2,766 mm x 35.4 mm
Housing material	Metal, Aluminum
Lens cover material	Plastic / PMMA
Material of end caps	Diecast zinc
Net weight	2,850 g
Housing color	Yellow, RAL 1021
Type of fastening	Swivel mount Groove mounting Mounting bracket Mounting on Device Column

Operation and display

Part no.: 68001227 – MLC510R20-2700 – Safety light curtain receiver

Type of display	LED
Number of LEDs	2 Piece(s)

Environmental data

Ambient temperature, operation	-30 ... 55 °C
Ambient temperature, storage	-30 ... 70 °C
Relative humidity (non-condensing)	0 ... 95 %

Certifications

Degree of protection	IP 65
Protection class	III
Certifications	c CSA US S Mark TÜV Süd c TÜV NRTL US
Vibration resistance	50 m/s ²
Shock resistance	100 m/s ²
US patents	US 6,418,546 B

Classification

eCl@ss 8.0	27272704
eCl@ss 9.0	27272704
ETIM 5.0	EC002549

Suitable transmitters

	Part no.	Designation	Article	Description
	68000227	MLC500T20-2700	Safety light curtain transmitter	Resolution: 20 mm Protective field height: 2,700 mm Operating range: 0 ... 15 m Connection: Connector, M12, Metal, 5 -pin

Dimensioned drawings

All dimensions in millimeters

Calculation of the effective protective field height $H_{PFE} = H_{PFN} + B + C$

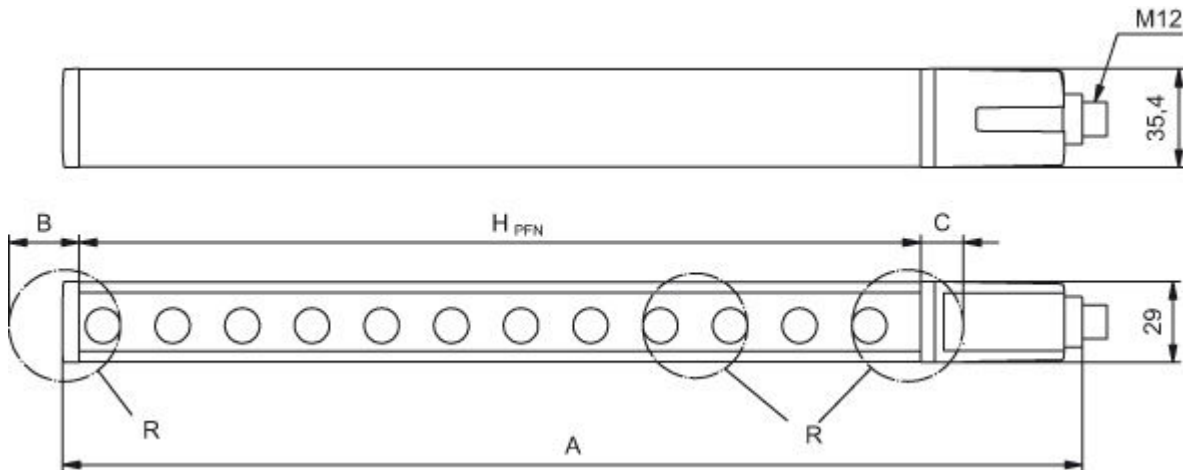

- HPFE Effective protective field height = 2717 mm
- HPFN Nominal protective field height = 2700 mm
- A Total height = 2766 mm
- B 7 mm
- C 10 mm
- R Effective protective field height H_{PFE} goes beyond the dimensions of the optics area to the outer borders of the circles labeled with R.

Electrical connection

Connection 1	
Type of connection	Connector
Function	Machine interface
Thread size	M12
Type	Male
Material	Metal
No. of pins	5 -pin
Encoding	A-coded
Connector housing	FE/SHIELD

Pin	Pin assignment	Conductor color
1	VIN1	Brown
2	OSSD1	White
3	VIN2	Blue
4	OSSD2	Black
5	FE/SHIELD	Gray

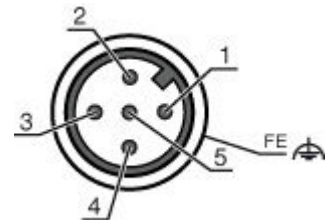

Circuit diagrams

Connection diagram receiver

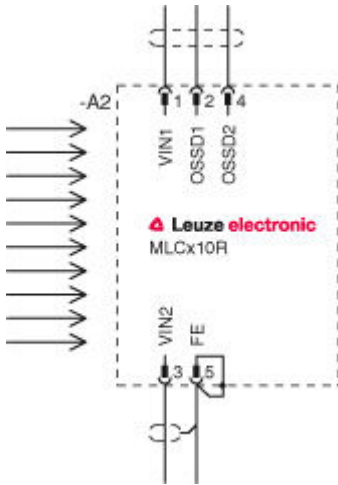

- VIN1 = +24 V, VIN2 = 0 V: transmission channel C1
- VIN1 = 0 V, VIN2 = +24 V: transmission channel C2

Circuit diagram example with downstream MSI-SR4B safety relay

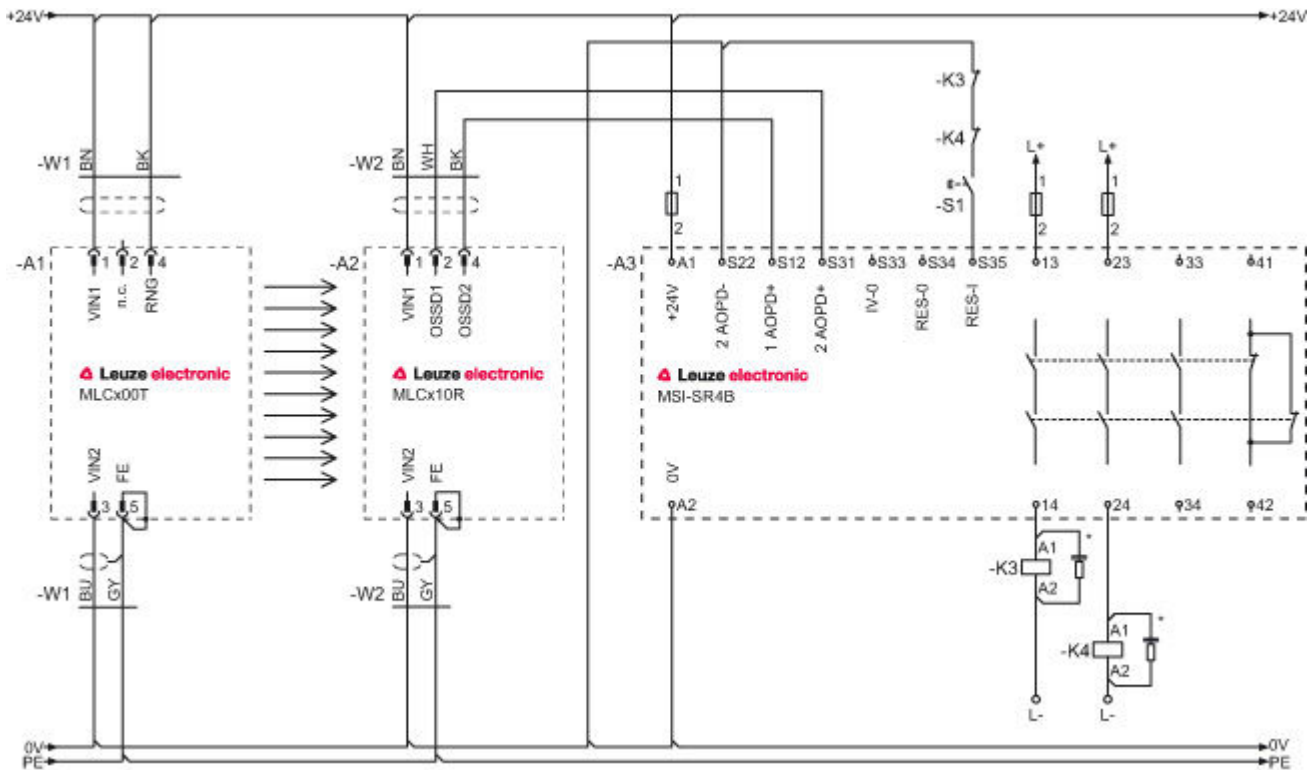

Operation and display

LEDs

LED	Display	Meaning
1	Off	Device switched off
	Red, continuous light	OSSD off.
	Red, flashing, 1 Hz	External error
	Red, flashing, 10 Hz	Internal error
	Green, flashing, 1 Hz	OSSD on, weak signal
	Green, continuous light	OSSD on
2	Off	Transmission channel C1
	Red, continuous light	OSSD off, transmission channel C2

Part number code

Part designation: **MLCxyy-za-hhhhei-ooo**







MLC	Safety light curtain
x	Series: 3: MLC 300 5: MLC 500
yy	Function classes: 00: Transmitter 01: transmitter (AIDA) 02: Transmitter with test input 10: Basic receiver - automatic restart 11: basic receiver - automatic restart (AIDA) 20: Standard receiver - EDM/RES selectable 30: Extended receiver - blanking/muting
z	Device type: T: transmitter R: receiver
a	Resolution: 14: 14 mm 20: 20 mm 30: 30 mm 40: 40 mm 90: 90 mm
hhh	Protective field height: 150 ... 3000: from 150 mm to 3000 mm
e	Host/Guest (optional): H: Host MG: Middle Guest G: Guest
i	Interface (optional): /A: AS-i
ooo	Option: /V: high Vibration-proof EX2: explosion protection (zones 2 + 22) SPG: Smart Process Gating

Note

A list with all available device types can be found on the Leuze electronic website at www.leuze.com.

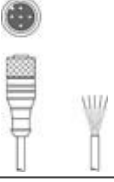
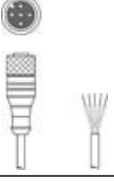
Accessories

Connection technology - Connection cables

	Part no.	Designation	Article	Description
	429088	CB-M12-15000-5GF	Connection cable	Connection 1: Connector, M12, Axial, Female, A-coded, 5 -pin Connection 2: Open end Shielded: No Cable length: 15,000 mm Sheathing material: PUR
	678057	CB-M12-15000E-5GF	Connection cable	Connection 1: Connector, M12, Axial, Female, A-coded, 5 -pin Connection 2: Open end Shielded: Yes Cable length: 15,000 mm Sheathing material: PUR
	429089	CB-M12-25000-5GF	Connection cable	Connection 1: Connector, M12, Axial, Female, A-coded, 5 -pin Connection 2: Open end Shielded: No Cable length: 25,000 mm Sheathing material: PUR
	678058	CB-M12-25000E-5GF	Connection cable	Connection 1: Connector, M12, Axial, Female, A-coded, 5 -pin Connection 2: Open end Shielded: Yes Cable length: 25,000 mm Sheathing material: PUR
	429281	CB-M12-50000-5GF	Connection cable	Connection 1: Connector, M12, Axial, Female, A-coded, 5 -pin Connection 2: Open end Shielded: No Cable length: 50,000 mm Sheathing material: PUR
	50133860	KD S-M12-5A-P1-050	Connection cable	Connection 1: Connector, M12, Axial, Female, A-coded, 5 -pin Connection 2: Open end Shielded: Yes Cable length: 5,000 mm Sheathing material: PUR
	50133861	KD S-M12-5A-P1-100	Connection cable	Connection 1: Connector, M12, Axial, Female, A-coded, 5 -pin Connection 2: Open end Shielded: Yes Cable length: 10,000 mm Sheathing material: PUR
	50137013	KD S-M12-5A-P1-500	Connection cable	Connection 1: Connector, M12, Axial, Female, A-coded, 5 -pin Connection 2: Open end Shielded: Yes Cable length: 10,000 mm Sheathing material: PVC
	50133841	KD U-M12-5A-P1-050	Connection cable	Connection 1: Connector, M12, Axial, Female, A-coded, 5 -pin Connection 2: Open end Shielded: No Cable length: 5,000 mm Sheathing material: PUR



Part no.: 68001227 – MLC510R20-2700 – Safety light curtain receiver

	Part no.	Designation	Article	Description
	50132534	KD U-M12-5A-P1-100	Connection cable	Connection 1: Connector, M12, Axial, Female, A-coded, 5 -pin Connection 2: Open end Shielded: No Cable length: 10,000 mm Sheathing material: PUR



Connection technology - Connectors

	Part no.	Designation	Article	Description
	429175	CB-M12-5GF	Connector	Connection: Connector, M12, Axial, Female, A-coded, 5 -pin

Mounting technology - Mounting brackets

	Part no.	Designation	Article	Description
	429056	BT-2L	Mounting bracket set	Design of mounting device: Angle, L-shape Mounting bracket, at system: Through-hole mounting Mounting bracket, at device: Screw type Material: Metal
	429057	BT-2Z	Mounting bracket set	Design of mounting device: Angle, Z-shape Mounting bracket, at system: Through-hole mounting Mounting bracket, at device: Screw type Material: Metal





Mounting technology - Swivel mounts

	Part no.	Designation	Article	Description
	429393	BT-2HF	Mounting bracket set	Contains: 2x BT-HF swivel mount, 1 cylinder for mounting on the light curtain Mounting bracket, at system: Through-hole mounting Mounting bracket, at device: Clampable Type of mounting device: Turning, 360° Material: Metal, Plastic
	429394	BT-2HF-S	Mounting bracket set	Contains: 2x BT-HF swivel mount, 1 cylinder for mounting on the light curtain Mounting bracket, at system: Through-hole mounting Mounting bracket, at device: Clampable Type of mounting device: Turning, 360° Material: Metal, Plastic Shock absorber: Yes

Mounting technology - Other

	Part no.	Designation	Article	Description
	425740	BT-10NC60	Sliding block set	Contains: 10x BT-NC sliding block Bore hole 1: Ø 4.7 mm Bore hole 2: M6 Design of mounting device: Sliding block Mounting bracket, at system: Mounting thread Mounting bracket, at device: Groove mounting Material: Metal



Part no.: 68001227 – MLC510R20-2700 – Safety light curtain receiver

	Part no.	Designation	Article	Description
	425741	BT-10NC64	Sliding block set	Contains: 10x BT-NC-M4-M6 sliding block Bore hole 1: M4 Bore hole 2: M6 Design of mounting device: Sliding block Mounting bracket, at system: Mounting thread Mounting bracket, at device: Groove mounting Material: Metal
	425742	BT-10NC65	Sliding block set	Contains: 10x BT-NC-M5-M6 sliding block Bore hole 1: M5 Bore hole 2: M6 Design of mounting device: Sliding block Mounting bracket, at system: Mounting thread Mounting bracket, at device: Groove mounting Material: Metal
	424417	BT-2P40	Mounting bracket set	Contains: 2x BT-P40 clamp bracket Design of mounting device: Mounting clamp Mounting bracket, at system: Groove mounting Mounting bracket, at device: Groove mounting Type of mounting device: Clampable Material: Metal
	424422	BT-2SB10	Mounting bracket set	Contains: 2x BT-SB10 Design of mounting device: Mounting clamp Mounting bracket, at system: Through-hole mounting Mounting bracket, at device: Clampable, an der seitlichen C-Nut Type of mounting device: Swiveling Swivel range: -8 ... 8 ° Material: Metal
	424423	BT-2SB10-S	Mounting bracket set	Contains: 2x BT-SB10-S Design of mounting device: Mounting clamp Mounting bracket, at system: Through-hole mounting Mounting bracket, at device: Clampable, an der seitlichen C-Nut Swivel range: -8 ... 8 ° Material: Metal Shock absorber: Yes

Test rods

	Part no.	Designation	Article	Description
	349939	AC-TR20/40	Test piece	Diameter 1: 20 mm Diameter 2: 40 mm Housing material: Plastic, Terluran HH106 black

Alignment aids

	Part no.	Designation	Article	Description
	427300	AC-ALM	Alignment aid	Housing material: Plastic
	520101	AC-ALM-M	Alignment aid	Housing material: Plastic
	560020	LA-78U	Alignment aid	Light source: laser, Red Housing material: Metal

Part no.: 68001227 – MLC510R20-2700 – Safety light curtain receiver

	Part no.	Designation	Article	Description
	520004	LA-78UDC	Alignment aid	Light source: laser, Red Housing material: Metal

Device columns

	Part no.	Designation	Article	Description
	549865	UDC-3100-S2	Device column	Dimensions: 160 mm x 3,160 mm x 149 mm Column height without foot: 3,100 mm Functions: Mounting and protection of light curtains and multiple light beam devices, Adjustable, 3 directions

Notes

Observe intended use!
<ul style="list-style-type: none"> • The product may only be put into operation by competent persons. • Only use the product in accordance with its intended use.