



Figure can vary

**Part no.: 66502000**  
**MLD500-T1L**  
**Single beam safety device transmitter**



## Contents

- Technical data
- Dimensioned drawings
- Electrical connection
- Operation and display
- Suitable receivers
- Part number code
- Notes
- Accessories

## Technical data

<b>Basic data</b>	
Series	MLD 500
<b>Special design</b>	
Special design	Integrated laser alignment aid
<b>Functions</b>	
Functions	Range reduction
<b>Characteristic parameters</b>	
Type	4, IEC/EN 61496
SIL	3, IEC 61508
SILCL	3, IEC/EN 62061
MTTF <sub>d</sub>	204 years, EN ISO 13849-1
Mission time T <sub>M</sub>	20 years, EN ISO 13849-1
<b>Protective field data</b>	
Operating range	0.5 ... 70 m
<b>Optical data</b>	
Light source	LED, Infrared
LED light wavelength	850 nm
Transmitted-signal shape	Pulsed
LED group	Exempt group in acc. with EN 62471:2008
<b>Electrical data</b>	
Protective circuit	Overvoltage protection Short circuit protected
<b>Performance data</b>	
Supply voltage U <sub>B</sub>	24 V, DC, -20 ... 20 %
Current consumption, max.	50 mA, Without external load
Fuse	External with max. 3 A
<b>Connection</b>	
Number of connections	1 Piece(s)
<b>Connection 1</b>	
Type of connection	Connector
Function	Machine interface
Thread size	M12
Material	Metal
No. of pins	5 -pin
<b>Cable properties</b>	
Permissible conductor cross section, typ.	0.25 mm <sup>2</sup>
Permissible cable resistance to load, max.	200 Ω
<b>Mechanical data</b>	
Design	Cubic

## Part no.: 66502000 – MLD500-T1L – Single beam safety device transmitter

Dimension (W x H x L)	52 mm x 193 mm x 64.7 mm
Housing material	Metal, Aluminum
Lens cover material	Plastic / PMMA
Material of end caps	Diecast zinc
Net weight	600 g
Housing color	Yellow, RAL 1021
Type of fastening	Groove mounting Swivel mount

### Operation and display

Type of display	LED
Number of LEDs	1 Piece(s)

### Environmental data

Ambient temperature, operation	-30 ... 55 °C
Ambient temperature, storage	-40 ... 75 °C
Relative humidity (non-condensing)	0 ... 95 %

### Certifications

Degree of protection	IP 67
Protection class	III
Certifications	TÜV Süd c TÜV NRTL US c CSA US
US patents	US 6,418,546 B US 7,741,595 B

### Classification

eCl@ss 8.0	27272701
eCl@ss 9.0	27272701
ETIM 5.0	EC001831
ETIM 6.0	EC001831

## Dimensioned drawings

All dimensions in millimeters

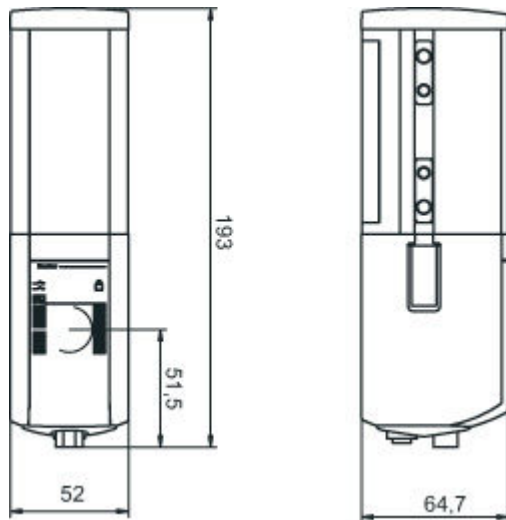

## Electrical connection

Connection 1	
Type of connection	Connector
Function	Machine interface
Thread size	M12
Type	Male
Material	Metal
No. of pins	5 - pin
Encoding	A-coded

Pin	Pin assignment	Conductor color
1	+24V	Brown
2	n.c.	White
3	0 V	Blue
4	n.c.	Black
5	n.c.	Gray

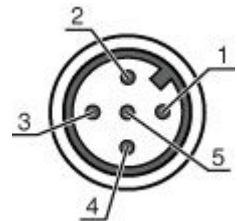



## Operation and display

### LEDs

LEDs per light axis	Meaning
Green, continuous light	Transmitted beam active
Off	Transmitted beam not active

## Suitable receivers

	Part no.	Designation	Article	Description
	66536000	MLD510-R1L	Single beam safety device receiver	Response time: 25 ms Connection: Connector, M12, Metal, 5 -pin Special design: Reflective element for laser alignment aid
	66556000	MLD520-R1L	Single beam safety device receiver	Response time: 25 ms Connection: Connector, M12, Metal, 8 -pin Special design: Reflective element for laser alignment aid
	66566000	MLD530-R1L	Single beam safety device receiver	Response time: 50 ms Connection: Connector, M12, Metal, 8 -pin Special design: Reflective element for laser alignment aid

## Part number code

Part designation: **MLDxyy-zab/t**

MLD	Multiple light beam safety device
x	<b>Series:</b> 3: MLD 300 5: MLD 500
yy	<b>Function classes:</b> 00: Transmitter 10: automatic restart 12: external testing 20: EDM/RES 30: muting 35: timing controlled 4-sensor muting
z	<b>Device type:</b> T: transmitter R: receiver RT: transceiver xT: transmitter with high range xR: receiver for high range
a	Number of beams
b	<b>Option:</b> L: integrated laser alignment aid (for transmitter/receiver) M: integrated status indicator (MLD 320, MLD 520) or integrated status and muting indicator (MLD 330, MLD 335, MLD 510/A, MLD 530, MLD 535) E: connection socket for external muting indicator (AS-i models only)
/t	<b>Safety-related switching outputs (OSSDs), connection technology:</b> -: transistor output, M12 plug A: integrated AS-i interface, M12 plug, (safety bus system)

## Notes

### WARNING! LASER RADIATION – LASER CLASS 2

#### Never look directly into the beam!

The device satisfies the requirements of IEC 60825-1:2007 (EN 60825-1:2007) safety regulations for a product of **laser class 2** as well as the U.S. 21 CFR 1040.10 regulations with deviations corresponding to "Laser Notice No. 50" from June 24, 2007.

- Never look directly into the laser beam or in the direction of reflected laser beams! If you look into the beam path over a longer time period, there is a risk of injury to the retina.
- Do not point the laser beam of the device at persons!
- Interrupt the laser beam using a non-transparent, non-reflective object if the laser beam is accidentally directed towards a person.
- When mounting and aligning the device, avoid reflections of the laser beam off reflective surfaces!
- CAUTION! Use of controls or adjustments or performance of procedures other than specified herein may result in hazardous light exposure.
- Observe the applicable statutory and local laser protection regulations.
- The device must not be tampered with and must not be changed in any way.  
There are no user-serviceable parts inside the device.  
Repairs must only be performed by Leuze electronic GmbH + Co. KG.

### NOTE



#### Affix laser information and warning signs!

Laser information and warning signs are affixed to the device. In addition, self-adhesive laser information and warning signs (stick-on labels) are supplied in several languages.



- Affix the laser information sheet to the device in the language appropriate for the place of use. When using the device in the US, use the stick-on label with the "Complies with 21 CFR 1040.10" note.
- Affix the laser information and warning signs near the device if no signs are attached to the device (e.g. because the device is too small) or if the attached laser information and warning signs are concealed due to the installation position.
- Affix the laser information and warning signs so that they are legible without exposing the reader to the laser radiation of the device or other optical radiation.

## Accessories



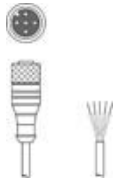

### Connection technology - Connection cables

	Part no.	Designation	Article	Description
	50133860	KD S-M12-5A-P1-050	Connection cable	Connection 1: Connector, M12, Axial, Female, A-coded, 5 -pin Connection 2: Open end Shielded: Yes Cable length: 5,000 mm Sheathing material: PUR
	50133861	KD S-M12-5A-P1-100	Connection cable	Connection 1: Connector, M12, Axial, Female, A-coded, 5 -pin Connection 2: Open end Shielded: Yes Cable length: 10,000 mm Sheathing material: PUR



Part no.: 66502000 – MLD500-T1L – Single beam safety device transmitter

	Part no.	Designation	Article	Description
	50137014	KD S-M12-5A-P1-150	Connection cable	Connection 1: Connector, M12, Axial, Female, A-coded, 5-pin Connection 2: Open end Shielded: Yes Cable length: 10,000 mm Sheathing material: PVC
	50137013	KD S-M12-5A-P1-500	Connection cable	Connection 1: Connector, M12, Axial, Female, A-coded, 5-pin Connection 2: Open end Shielded: Yes Cable length: 10,000 mm Sheathing material: PVC

### Mounting technology - Swivel mounts

	Part no.	Designation	Article	Description
	560340	BT-SET-240BC	Mounting bracket set	Fastening, at system: Through-hole mounting Mounting bracket, at device: Clampable Type of mounting device: Turning, 240° Material: Metal
	540351	BT-SET-240CC-E	Mounting bracket set	Fastening, at system: Through-hole mounting Mounting bracket, at device: Clampable Type of mounting device: Turning, 240° Material: Metal, Plastic
	560343	BT-SET-240CCS	Mounting bracket set	Fastening, at system: Through-hole mounting Mounting bracket, at device: Clampable Type of mounting device: Turning, 240°, Shock absorber Material: Metal Shock absorber: Yes
	540353	BT-SET-240CCS-E	Mounting bracket set	Fastening, at system: Through-hole mounting Mounting bracket, at device: Clampable Type of mounting device: Turning, 240°, Shock absorber Material: Metal, Plastic Shock absorber: Yes

### Mounting technology - Other



	Part no.	Designation	Article	Description
	424417	BT-2P40	Mounting bracket set	Contains: BT-P40 clamp bracket, 2x Design of mounting device: Mounting clamp Fastening, at system: Groove mounting Mounting bracket, at device: Groove mounting Type of mounting device: Clampable Material: Metal
	424422	BT-2SB10	Mounting bracket set	Contains: 2x BT-SB10 Design of mounting device: Mounting clamp Fastening, at system: Through-hole mounting Mounting bracket, at device: Clampable, On the lateral C-groove Type of mounting device: Swiveling Swivel range: -8 ... 8° Material: Metal
	424423	BT-2SB10-S	Mounting bracket set	Contains: 2x BT-SB10-S Design of mounting device: Mounting clamp Fastening, at system: Through-hole mounting Mounting bracket, at device: Clampable, On the lateral C-groove Swivel range: -8 ... 8° Material: Metal Shock absorber: Yes

Part no.: 66502000 – MLD500-T1L – Single beam safety device transmitter

## Alignment aids

	Part no.	Designation	Article	Description
	520071	AC-MK1	Adapter	Dimensions: 23.3 mm x 17.5 mm x 24 mm Net weight: 20 g Housing color: Black Functions: Activation of the laser alignment aid

## Services

	Part no.	Designation	Article	Description
	S981050	CS40-I-140	Safety inspection "Safety light barriers"	Details: Checking of a safety light barrier application in accordance with current standards and guidelines. Inclusion of the device and machine data in a database, production of a test log per application. Conditions: It must be possible to stop the machine, support provided by customer's employees and access to the machine for Leuze employees must be ensured. Restrictions: Travel costs and accommodation expenses charged separately and according to expenditure.
	S981046	CS40-S-140	Start-up support	Details: For safety devices including stopping time measurement and initial inspection. Conditions: Devices and connection cables are already mounted, price not including travel costs and, if applicable, accommodation expenses. Restrictions: Max. 2 h., no mechanical (mounting) and electrical (wiring) work performed, no changes (attachments, wiring, programming) to third-party components in the nearby environment.