



Figure can vary

Part no.: 66501000
MLD500-T1
Single beam safety device transmitter



Contents

- Technical data
- Dimensioned drawings
- Electrical connection
- Operation and display
- Suitable receivers
- Part number code
- Accessories

Technical data

Basic data	
Series	MLD 500
Functions	
Functions	Range reduction
Characteristic parameters	
Type	4, IEC/EN 61496
SIL	3, IEC 61508
SILCL	3, IEC/EN 62061
Performance Level (PL)	e, EN ISO 13849-1:2008
MTTF _d	204 years, EN ISO 13849-1
Mission time T _M	20 years, EN ISO 13849-1
Category	4, EN ISO 13849:2008
Protective field data	
Operating range	0.5 ... 70 m
Optical data	
Light source	LED, Infrared
LED light wavelength	850 nm
Transmitted-signal shape	Pulsed
LED group	Exempt group in acc. with EN 62471:2008
Opening angle, max.	-2.5 ... 2.5 °
Electrical data	
Protective circuit	Overvoltage protection Short circuit protected
Performance data	
Supply voltage U _B	24 V, DC, -20 ... 20 %
Current consumption, max.	50 mA, Without external load
Fuse	External with max. 3 A
Connection	
Number of connections	1 Piece(s)
Connection 1	
Type of connection	Connector
Function	Machine interface
Thread size	M12
Material	Metal
No. of pins	5 -pin
Cable properties	
Permissible conductor cross section, typ.	0.25 mm ²
Permissible cable resistance to load, max.	200 Ω
Mechanical data	
Design	Cubic

Part no.: 66501000 – MLD500-T1 – Single beam safety device transmitter

Dimension (W x H x L)	52 mm x 193 mm x 64.7 mm
Housing material	Metal, Aluminum
Lens cover material	Plastic / PMMA
Material of end caps	Diecast zinc
Net weight	600 g
Housing color	Yellow, RAL 1021
Type of fastening	Swivel mount Groove mounting

Operation and display

Type of display	LED
Number of LEDs	1 Piece(s)

Environmental data

Ambient temperature, operation	-30 ... 55 °C
Ambient temperature, storage	-40 ... 75 °C
Relative humidity (non-condensing)	0 ... 95 %

Certifications

Degree of protection	IP 67
Protection class	III
Certifications	c CSA US c TÜV NRTL US TÜV Süd
US patents	US 7,741,595 B US 6,418,546 B

Classification

Customs tariff number	85365019
eCl@ss 8.0	27272701
eCl@ss 9.0	27272701
ETIM 5.0	EC001831
ETIM 6.0	EC001831

Dimensioned drawings

All dimensions in millimeters

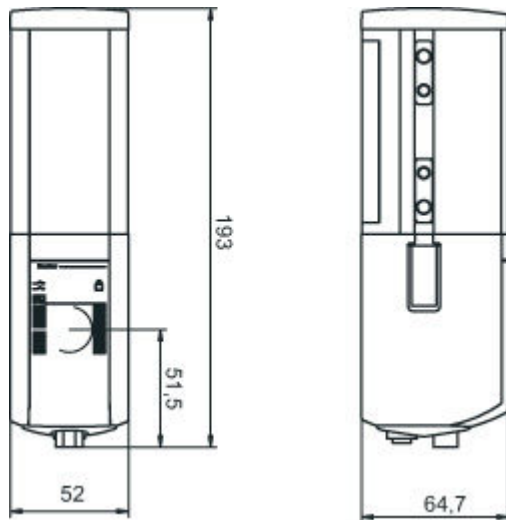

Electrical connection

Connection 1	
Type of connection	Connector
Function	Machine interface
Thread size	M12
Type	Male
Material	Metal
No. of pins	5 - pin
Encoding	A-coded

Pin	Pin assignment	Conductor color
1	+24V	Brown
2	n.c.	White
3	0 V	Blue
4	n.c.	Black
5	n.c.	Gray

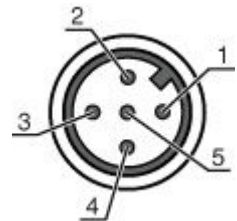



Operation and display

LEDs

LEDs per light axis	Meaning
Green, continuous light	Transmitted beam active
Off	Transmitted beam not active

Part no.: 66501000 – MLD500-T1 – Single beam safety device transmitter

Suitable receivers

	Part no.	Designation	Article	Description
	66533000	MLD510-R1	Single beam safety device receiver	Response time: 25 ms Connection: Connector, M12, Metal, 5 -pin
	66553000	MLD520-R1	Single beam safety device receiver	Response time: 25 ms Connection: Connector, M12, Metal, 8 -pin
	66563000	MLD530-R1	Single beam safety device receiver	Response time: 50 ms Connection: Connector, M12, Metal, 8 -pin

Part number code

Part designation: **MLDxyy-zab/t**





MLD	Multiple light beam safety device
x	Series: 3: MLD 300 5: MLD 500
yy	Function classes: 00: Transmitter 10: automatic restart 12: external testing 20: EDM/RES 30: muting 35: timing controlled 4-sensor muting
z	Device type: T: transmitter R: receiver RT: transceiver xT: transmitter with high range xR: receiver for high range
a	Number of beams
b	Option: L: integrated laser alignment aid (for transmitter/receiver) M: integrated status indicator (MLD 320, MLD 520) or integrated status and muting indicator (MLD 330, MLD 335, MLD 510/A, MLD 530, MLD 535) E: connection socket for external muting indicator (AS-i models only)
/t	Safety-related switching outputs (OSSDs), connection technology: -: transistor output, M12 plug A: integrated AS-i interface, M12 plug, (safety bus system)

Note





A list with all available device types can be found on the Leuze electronic website at www.leuze.com.

Accessories

Connection technology - Connection cables



	Part no.	Designation	Article	Description
	50133860	KD S-M12-5A-P1-050	Connection cable	Connection 1: Connector, M12, Axial, Female, A-coded, 5 -pin Connection 2: Open end Shielded: Yes Cable length: 5,000 mm Sheathing material: PUR
	50133861	KD S-M12-5A-P1-100	Connection cable	Connection 1: Connector, M12, Axial, Female, A-coded, 5 -pin Connection 2: Open end Shielded: Yes Cable length: 10,000 mm Sheathing material: PUR
	50137014	KD S-M12-5A-P1-150	Connection cable	Connection 1: Connector, M12, Axial, Female, A-coded, 5 -pin Connection 2: Open end Shielded: Yes Cable length: 10,000 mm Sheathing material: PVC
	50137013	KD S-M12-5A-P1-500	Connection cable	Connection 1: Connector, M12, Axial, Female, A-coded, 5 -pin Connection 2: Open end Shielded: Yes Cable length: 10,000 mm Sheathing material: PVC

Mounting technology - Swivel mounts



	Part no.	Designation	Article	Description
	560340	BT-SET-240BC	Mounting bracket set	Fastening, at system: Through-hole mounting Mounting bracket, at device: Clampable Type of mounting device: Turning, 240° Material: Metal
	540350	BT-SET-240BC-E	Mounting bracket set	Fastening, at system: Through-hole mounting Mounting bracket, at device: Clampable Type of mounting device: Turning, 240° Material: Metal, Plastic
	560343	BT-SET-240CCS	Mounting bracket set	Fastening, at system: Through-hole mounting Mounting bracket, at device: Clampable Type of mounting device: Turning, 240°, Shock absorber Material: Metal Shock absorber: Yes
	540353	BT-SET-240CCS-E	Mounting bracket set	Fastening, at system: Through-hole mounting Mounting bracket, at device: Clampable Type of mounting device: Turning, 240°, Shock absorber Material: Metal, Plastic Shock absorber: Yes

Part no.: 66501000 – MLD500-T1 – Single beam safety device transmitter

Mounting technology - Other

	Part no.	Designation	Article	Description
	424417	BT-2P40	Mounting bracket set	Contains: BT-P40 clamp bracket, 2x Bore hole 1: M6 Bore hole 2: M6 Design of mounting device: Mounting clamp Fastening, at system: Groove mounting Mounting bracket, at device: Groove mounting Type of mounting device: Clampable Material: Metal
	424422	BT-2SB10	Mounting bracket set	Contains: 2x BT-SB10 Design of mounting device: Mounting clamp Fastening, at system: Through-hole mounting Mounting bracket, at device: Clampable, On the lateral C-groove Type of mounting device: Swiveling Swivel range: -8 ... 8 ° Material: Metal
	424423	BT-2SB10-S	Mounting bracket set	Contains: 2x BT-SB10-S Design of mounting device: Mounting clamp Fastening, at system: Through-hole mounting Mounting bracket, at device: Clampable, On the lateral C-groove Swivel range: -8 ... 8 ° Material: Metal Shock absorber: Yes

Services

	Part no.	Designation	Article	Description
	S981050	CS40-I-140	Safety inspection "Safety light barriers"	Details: Checking of a safety light barrier application in accordance with current standards and guidelines. Inclusion of the device and machine data in a database, production of a test log per application. Conditions: It must be possible to stop the machine, support provided by customer's employees and access to the machine for Leuze employees must be ensured. Restrictions: Travel costs and accommodation expenses charged separately and according to expenditure.
	S981046	CS40-S-140	Start-up support	Details: For safety devices including stopping time measurement and initial inspection. Conditions: Devices and connection cables are already mounted, price not including travel costs and, if applicable, accommodation expenses. Restrictions: Max. 2 h., no mechanical (mounting) and electrical (wiring) work performed, no changes (attachments, wiring, programming) to third-party components in the nearby environment.