



Figure can vary

Part no.: 544001
MLC500T14-450-IP
Safety sensor/transmitter set



Contents

- Technical data
- Dimensioned drawings
- Electrical connection
- Circuit diagrams
- Operation and display
- Suitable receivers
- Part number code
- Notes
- Accessories

Technical data

Basic data	
Series	MLC 500
Device type	Transmitter
Contains	2x BT-IP swivel mount
Application	Finger protection
Functions	
Functions	Range reduction Transmission channel changeover
Characteristic parameters	
Type	4 , IEC/EN 61496
SIL	3 , IEC 61508
SILCL	3 , IEC/EN 62061
Mission time T_M	20 years , EN ISO 13849-1
Protective field data	
Resolution	14 mm
Protective field height	450 mm
Operating range	0 ... 4.8 m
Optical data	
Synchronization	Optical between transmitter and receiver
Light source	LED , Infrared
LED light wavelength	940 nm
Transmitted-signal shape	Pulsed
LED group	Exempt group in acc. with EN 62471:2008
Electrical data	
Protective circuit	Overvoltage protection Short circuit protected
Performance data	
Supply voltage U_B	24 V , DC , -20 ... 20 %
Current consumption, max.	50 mA
Fuse	2 A semi time-lag
Inputs	
Number of digital switching inputs	1 Piece(s)
Switching inputs	
Type	Digital switching input
Switching voltage high, min.	18 V
Switching voltage low, max.	2.5 V
Switching voltage, typ.	22.5 V
Voltage type	DC
Connection	
Number of connections	1 Piece(s)

Part no.: 544001 – MLC500T14-450-IP – Safety sensor/transmitter set
Connection 1

Type of connection	Cable with connector
Function	Machine interface
Cable length	15,000 mm
Sheathing material	PVC
Thread size	M12
Material	Metal
No. of pins	5 -pin

Cable properties

Permissible conductor cross section, typ.	0.25 mm ²
Length of connection cable, max.	100 m
Permissible cable resistance to load, max.	200 Ω

Mechanical data

Dimension	650 mm 52.5 mm
Housing material	Metal , Aluminum
Lens cover material	Plastic / PMMA
Material of end caps	Diecast zinc
Net weight	600 g
Housing color	Yellow, RAL 1021
Type of fastening	Swivel mount

Protective tube

Material	PMMA, clear
Material of end caps	V4A stainless steel (1.4404)
Material of clamping cylinder	PA 6
Material of pressure-equalization membrane	PA 6
Cable gland material	PA 6

Operation and display

Type of display	LED
Number of LEDs	2 Piece(s)

Environmental data

Ambient temperature, operation	0 ... 55 °C
Ambient temperature, storage	-30 ... 70 °C
Relative humidity (non-condensing)	0 ... 95 %

Certifications

Degree of protection	IP 65 IP 66 IP 67 IP 69K
Protection class	III
Certifications	c CSA US c TÜV NRTL US S Mark TÜV Süd
Vibration resistance	50 m/s ²
Shock resistance	100 m/s ²
US patents	US 6,418,546 B

Classification

Customs tariff number	85365019
eCl@ss 8.0	27272704
eCl@ss 9.0	27272704
ETIM 5.0	EC002549
ETIM 6.0	EC002549

Dimensioned drawings

All dimensions in millimeters

MLC safety light curtains pre-mounted in the IP protective tube

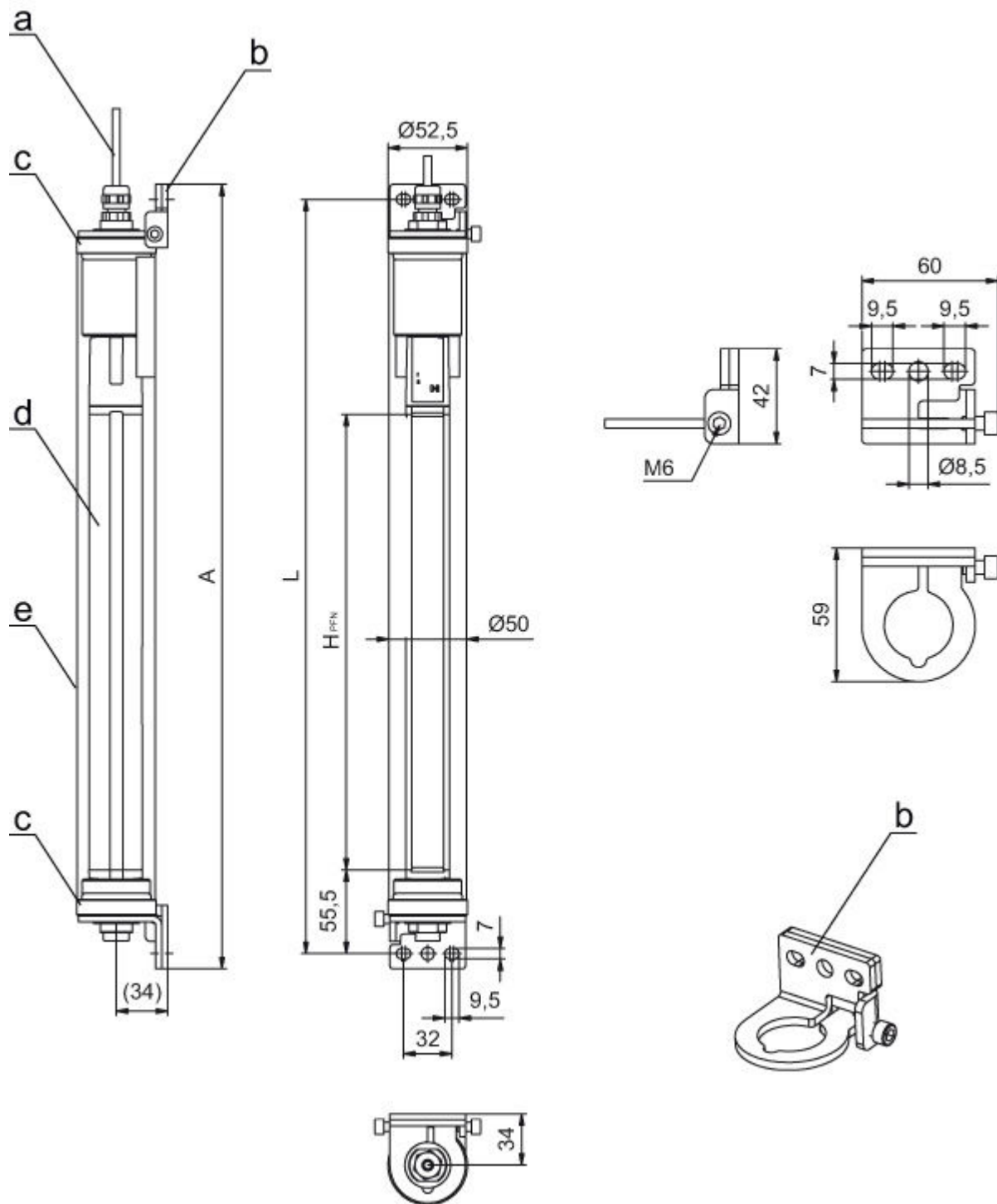

- a Connection cable
- b Mounting brackets for mounting
- c End caps, stainless steel V4A
- d MLC transmitter
- e IP protective tube
- A Total height incl. mounting brackets = 670 mm
- L Spacing of drilled holes for mounting brackets = 650 mm
- HPFN Effective protective field height = 450 mm

Electrical connection

Connection 1	
Type of connection	Cable with connector
Function	Machine interface
Cable length	15,000 mm
Sheathing material	PVC
Cable color	Black
Wire cross section	
Thread size	M12
Type	Male
Material	Metal
No. of pins	5 -pin
Encoding	A-coded
Connector housing	FE/SHIELD

Pin	Pin assignment	Conductor color
1	VIN1	Brown
2	n.c.	White
3	VIN2	Blue
4	RNG	Black
5	FE/SHIELD	Gray



Circuit diagrams

Transmission channel C1, reduced range

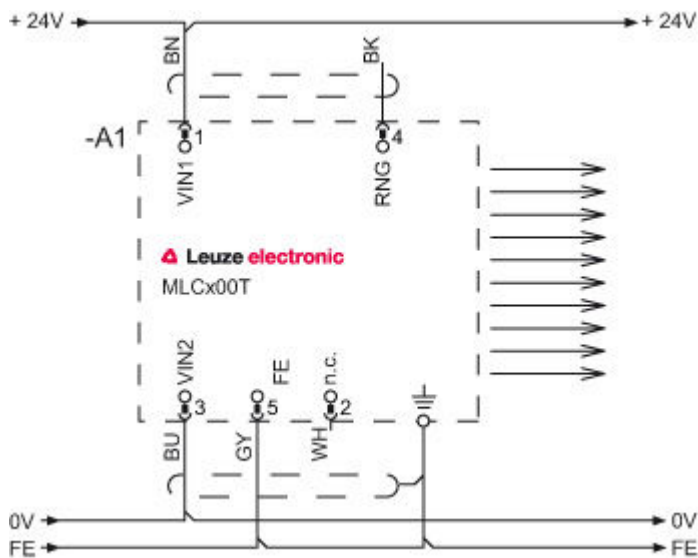

- 1 VIN1 = +24 V
- 3 VIN2 = 0 V
- 4 RNG = 0 V or open

Transmission channel C1, standard range

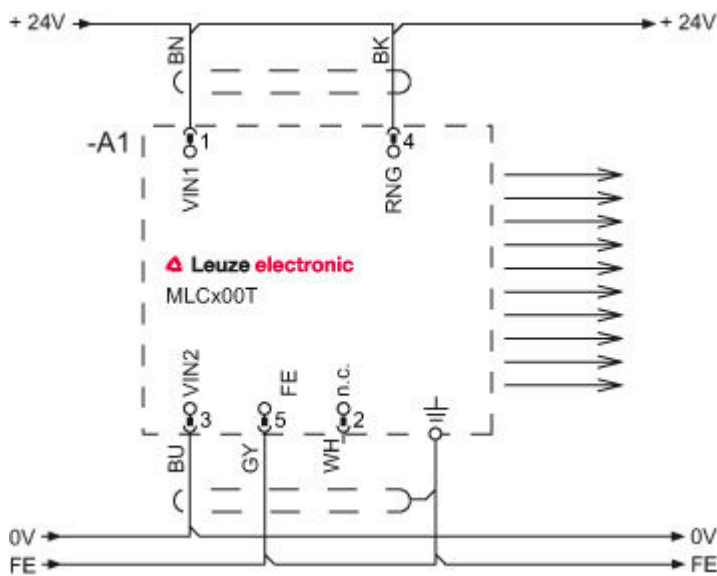

- 1 VIN1 = +24 V
- 3 VIN2 = 0 V
- 4 RNG = +24 V

Transmission channel C2, reduced range

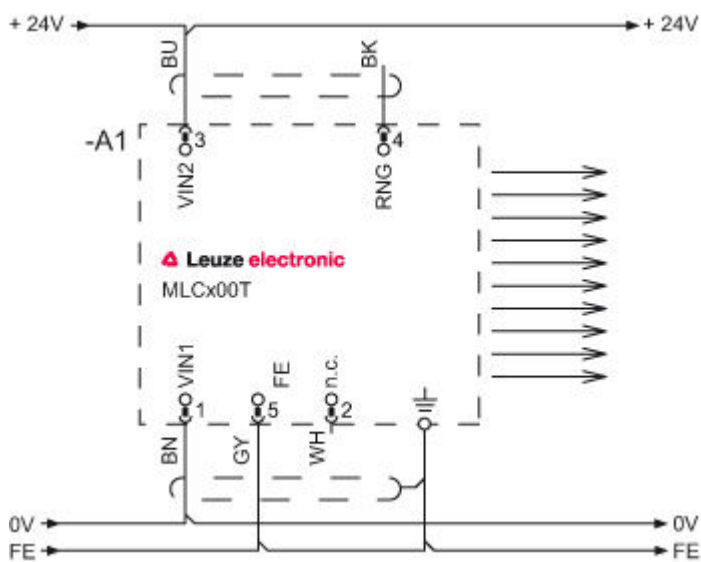

- 1 VIN1 = 0 V
- 3 VIN2 = +24 V
- 4 RNG = 0 V or open

Transmission channel C2, standard range

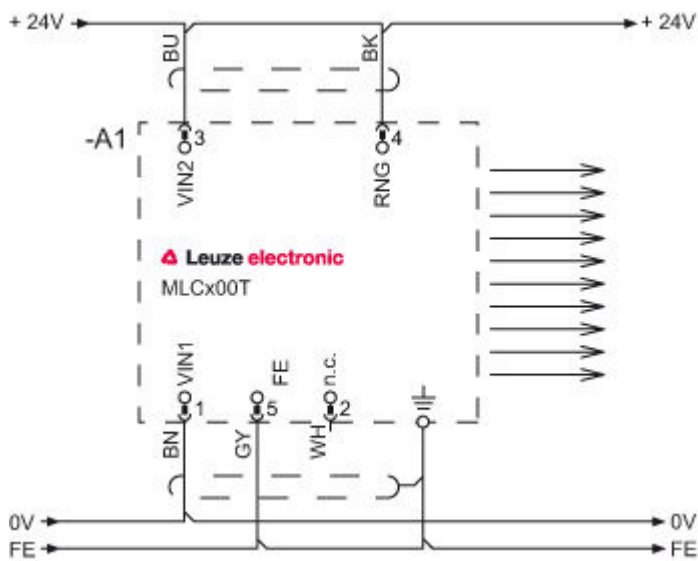

- 1 VIN1 = 0 V
- 3 VIN2 = +24 V
- 4 RNG = +24 V

Operation and display

LEDs

LED	Display	Meaning
1	Off	Device switched off
	Red, continuous light	Device error
	Green, continuous light	Normal operation
2	Green, flashing, 10 s long after switching on	Reduced range selected by the wiring of pin 4
	Off	Transmission channel C1
	Green, continuous light	Transmission channel C2

Suitable receivers

	Part no.	Designation	Article	Description
	544008	MLC510R14-450-IP	Safety sensor/ receiver set	Resolution: 14 mm Protective field height: 450 mm Response time: 11 ms Connection: Cable with connector, M12, Metal, 5 -pin, 15,000 mm, PVC Function package: Basic

Part number code

Part designation: **MLCxyy-za-hhhhei-ooo**

MLC	Safety light curtain
x	Series: 3: MLC 300 5: MLC 500
yy	Function classes: 00: Transmitter 01: transmitter (AIDA) 02: Transmitter with test input 10: Basic receiver - automatic restart 11: basic receiver - automatic restart (AIDA) 20: Standard receiver - EDM/RES selectable 30: Extended receiver - blanking/muting
z	Device type: T: transmitter R: receiver
a	Resolution: 14: 14 mm 20: 20 mm 30: 30 mm 40: 40 mm 90: 90 mm
hhhh	Protective field height: 150 ... 3000: from 150 mm to 3000 mm
e	Host/Guest (optional): H: Host MG: Middle Guest G: Guest
i	Interface (optional): /A: AS-i
ooo	Option: /V: high Vibration-proof EX2: explosion protection (zones 2 + 22) SPG: Smart Process Gating

Note

A list with all available device types can be found on the Leuze electronic website at www.leuze.com.

Notes

Observe intended use!

- The product may only be put into operation by competent persons.
- Only use the product in accordance with its intended use.

Accessories

Services

	Part no.	Designation	Article	Description
	S981050	CS40-I-140	Safety inspection "Safety light barriers"	Details: Checking of a safety light barrier application in accordance with current standards and guidelines. Inclusion of the device and machine data in a database, production of a test log per application. Conditions: It must be possible to stop the machine, support provided by customer's employees and access to the machine for Leuze employees must be ensured. Restrictions: Travel costs and accommodation expenses charged separately and according to expenditure.

Part no.: 544001 – MLC500T14-450-IP – Safety sensor/transmitter set

	Part no.	Designation	Article	Description
	S981046	CS40-S-140	Start-up support	Details: For safety devices including stopping time measurement and initial inspection. Conditions: Devices and connection cables are already mounted, price not including travel costs and, if applicable, accommodation expenses. Restrictions: Max. 2 h., no mechanical (mounting) and electrical (wiring) work performed, no changes (attachments, wiring, programming) to third-party components in the nearby environment.