



Figure can vary

Part no.: 53800231  
**RSL430-L/CU429-25**  
Safety laser scanner



## Contents

- . Technical data
- . Dimensioned drawings
- . Electrical connection
- . Operation and display
- . Notes
- . Accessories

## Technical data

<b>Basic data</b>	
Series	RSL 400
Application	Mobile danger zone guarding Mobile side guarding Stationary access guarding Stationary danger zone guarding
<b>Functions</b>	
Functions	Data output, configurable Dynamic contactor monitoring (EDM), selectable E-stop linkage Four-field mode Resolution, selectable Safe time delay, internal
<b>Characteristic parameters</b>	
Type	3, IEC/EN 61496
SIL	2, IEC 61508
SILCL	2, IEC/EN 62061
Performance Level (PL)	d, EN ISO 13849-1
PFH <sub>D</sub>	9E-08 per hour
Mission time T <sub>M</sub>	20 years, EN ISO 13849-1
Category	3, EN ISO 13849
<b>Protective field data</b>	
Scanning angle	270 °
Minimum adjustable range	50 mm
Number of field pairs, reversible	10 + 10
Number of quads, reversible	10 + 10
Number of protective functions	2 Piece(s)
Number of independent sensor configurations	2
Diffuse reflection, min.	1.8 %
Operating range	0 ... 6.25 m
<b>Warning field data</b>	
Number of field pairs	10 + 10
Operating range	0 ... 20 m
Object size	150 mm x 150 mm
Diffuse reflection, min.	10 %
<b>Optical data</b>	
Light source	Laser, Infrared
Laser light wavelength	905 nm
Laser class	1, IEC/EN 60825-1:2007
Transmitted-signal shape	Pulsed
Repetition frequency	90 kHz
<b>Measurement data</b>	
Distance resolution	1 mm
Detection range	0 ... 50 m

## Part no.: 53800231 – RSL430-L/CU429-25 – Safety laser scanner

Diffuse reflection	20 %
Angular resolution	0.1 °

### Electrical data

Protective circuit	Overvoltage protection
--------------------	------------------------

#### Performance data

Supply voltage $U_B$	24 V, DC, -30 ... 20 %
Current consumption (without load), max.	700 mA, (use power supply unit with 3 A)
Power consumption, max.	17 W, For 24 V, plus output load

#### Outputs

Number of safety-related switching outputs (OSSDs)	4 Piece(s)
--	------------

#### Safety-related switching outputs

Type	Safety-related switching output OSSD
Switching voltage high, min.	20.8 V
Switching voltage low, max.	2 V
Voltage type	DC

#### Safety-related switching output 1

Assignment	Connection 1, gray wire
Switching element	Transistor, PNP

#### Safety-related switching output 2

Assignment	Connection 1, pink wire
Switching element	Transistor, PNP

#### Safety-related switching output 3

Assignment	Connection 1, yellow/gray wire
Switching element	Transistor, PNP

#### Safety-related switching output 4

Assignment	Connection 1, pink/green wire
Switching element	Transistor, PNP

### Service interface

Type	Bluetooth
------	-----------

#### Bluetooth

Function	Configuration/parametering
Frequency band	2,400 ... 2,483.5 MHz
Radiated transmitting power	Max. 4.5 dBm (2.82 mW), class 2

Type	USB
------	-----

#### USB

Function	Configuration/parametering
Connection	USB 2.0 mini-B, socket
Transmission speed, max.	12 Mbit/s
Cable length	≤ 5m Longer cable lengths are possible using active cables.

### Connection

Number of connections	2 Piece(s)
-----------------------	------------

**Connection 1**

Type of connection	Cable
Function	Machine interface
Cable length	25,000 mm
Sheathing material	PVC
Cable color	Black
Number of conductors	29 -wire
Wire cross section supply	1 mm <sup>2</sup>
Wire cross section signals	0.14 mm <sup>2</sup>

**Connection 2**

Type of connection	Connector
Function	Data interface
Thread size	M12
Type	Female
Material	Metal
No. of pins	4 -pin
Encoding	D-coded

**Cable properties**

Cable resistance, max.	15 Ω
------------------------	------

**Mechanical data**

Dimension (W x H x L)	140 mm x 149 mm x 140 mm
Housing material	Metal Plastic, Diecast zinc,
Lens cover material	Plastic/PC
Net weight	3,000 g
Housing color	Yellow, RAL 1021
Type of fastening	Mounting plate Through-hole mounting Via optional mounting device

**Operation and display**

Type of display	Alphanumerical display LED indicator
Number of LEDs	6 Piece(s)
Type of configuration	Software Sensor Studio
Operational controls	Software Sensor Studio

**Environmental data**

Ambient temperature, operation	0 ... 50 °C
Ambient temperature, storage	-20 ... 60 °C
Relative humidity (non-condensing)	15 ... 95 %

**Certifications**

Degree of protection	IP 65
Protection class	III, EN 61140
Certifications	c TÜV Süd US c UL US TÜV Süd
Test procedure for EMC in accordance with standard	DIN 40839-1/3 EN 61496-1
Test procedure for oscillation in accordance with standard	EN 60068-2-6

Test procedure for continuous shock in accordance with standard	IEC 60068-2-29
US patents	US 2016/0086469 A US 7,656,917 B US 7,696,468 B US 8,520,221 B

**Classification**

Customs tariff number	85365019
eCl@ss 8.0	27272705
eCl@ss 9.0	27272705
ETIM 5.0	EC002550
ETIM 6.0	EC002550

## Dimensioned drawings

All dimensions in millimeters

Dimensions safety laser scanner with connection unit

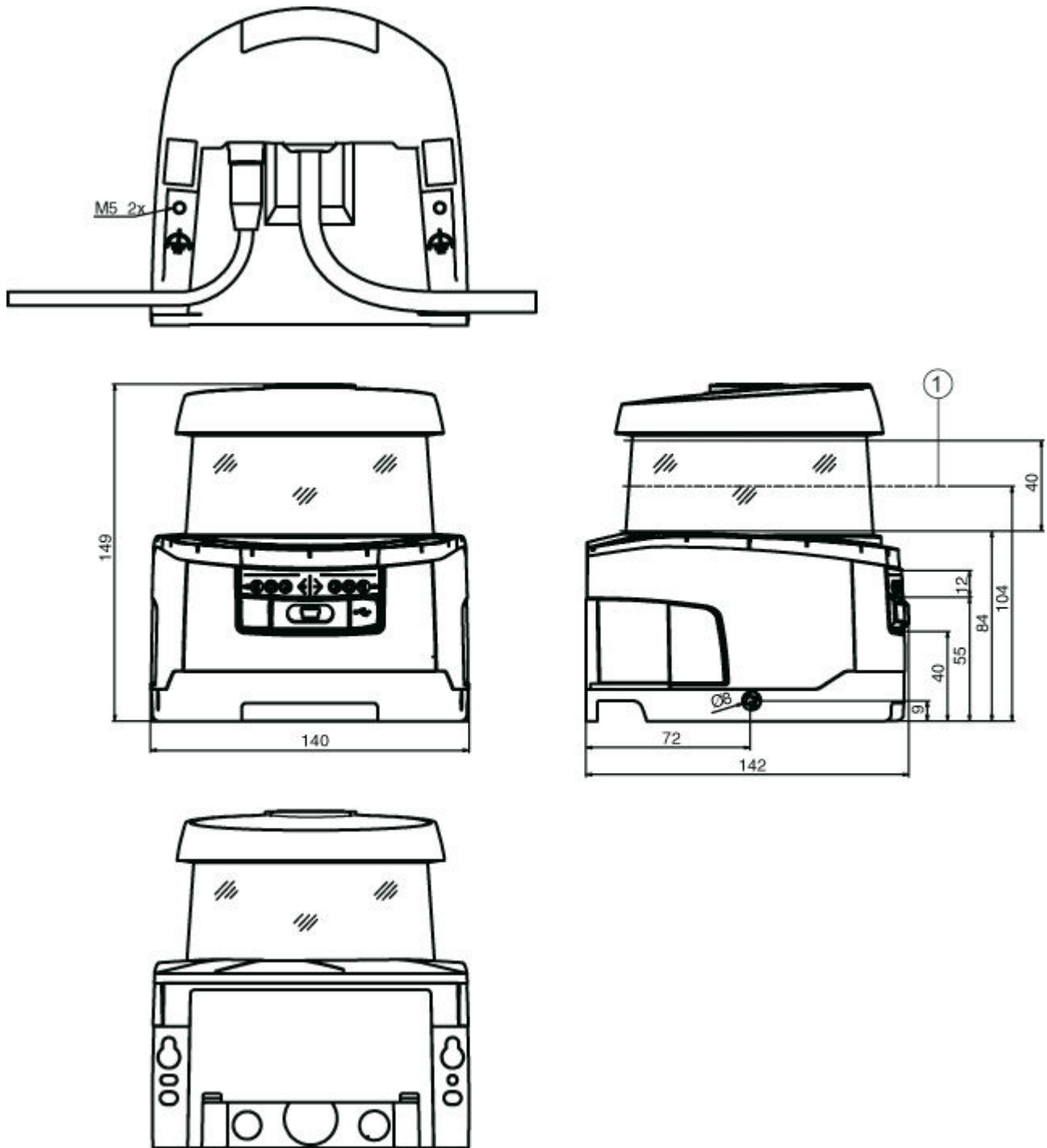

1 Scan level

Mounting dimensions safety laser scanner with connection unit

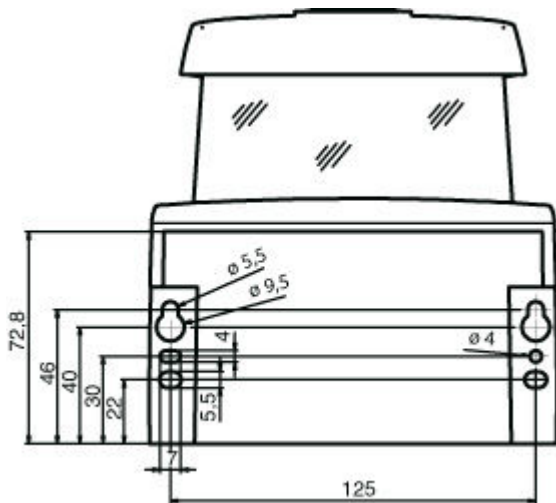

Minimum space requirements for installation and replacement of scanner unit

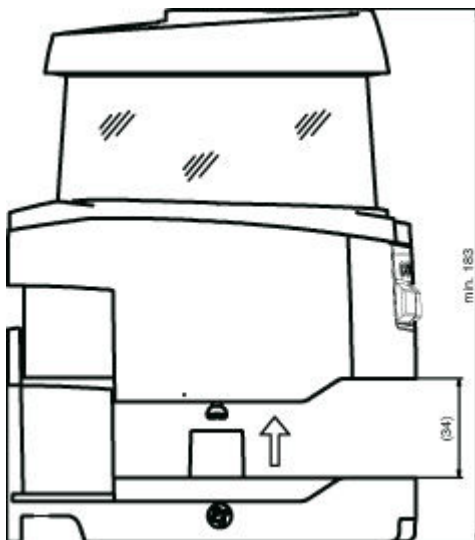

### Dimensions of scanning range

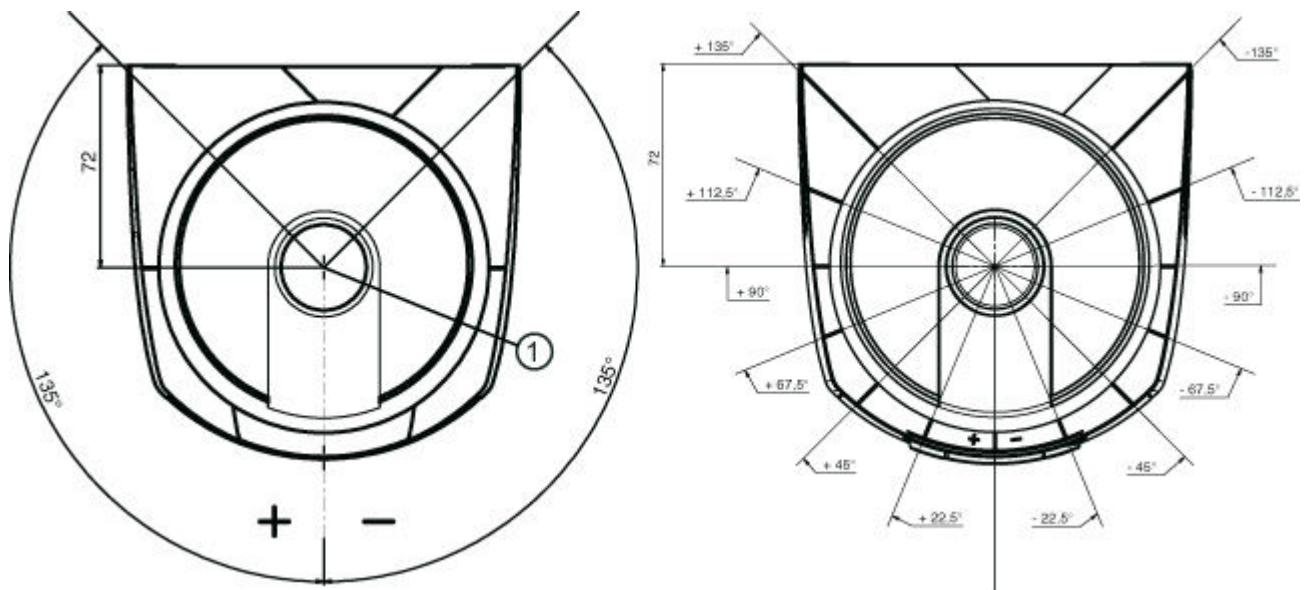

1 Reference point for distance measurement and protective field radius

### Electrical connection

Connection 1	
Type of connection	Cable
Function	Machine interface
Cable length	25,000 mm
Sheathing material	PVC
Cable color	Black
Number of conductors	29 -wire
Wire cross section	
Wire cross section supply	1 mm <sup>2</sup>
Wire cross section signals	0.14 mm <sup>2</sup>

Conductor color	Conductor assignment
White	RES1
Brown	+24V
Green	EA1
Yellow	A1
Gray	OSSDA1
Pink	OSSDA2
Blue	GND / Ground
Red	MELD
Black	F1
Violet	F2
Gray Pink	F3
Blue Red	F4
Green White	F5

Conductor color	Conductor assignment
Brown Green	SE1
White Yellow	SE2
Brown Yellow	A2
Gray White	A3
Brown Gray	A4
Pink White	EA2
Brown Pink	EA3
Blue White	EA4
Blue Brown	F6
Red White	F7
Brown Red	F8
Black White	F9
Black Brown	F10
Gray Green	RES2
Gray Yellow	OSSDB1
Green Pink	OSSDB2

Connection 2	
Type of connection	Connector
Function	Data interface
Thread size	M12
Type	Female
Material	Metal
No. of pins	4 -pin
Encoding	D-coded
Connector housing	FE/SHIELD

Pin	Pin assignment	Conductor color
1	TD+	Yellow
2	RD+	White
3	TD-	Orange
4	RD-	Blue
5		

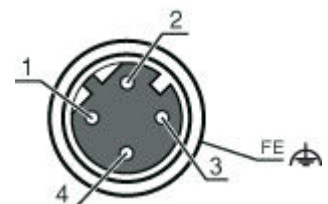

## Operation and display

### LEDs

LED	Display	Meaning
1	Off	Device switched off
	Red, continuous light	OSSD off
	Red, flashing	Error
	Green, continuous light	OSSD on
2	Off	RES deactivated or RES activated and released
	Yellow, flashing	Protective field occupied
	Yellow, continuous light	RES activated and blocked but ready to be unlocked - protective field free and linked sensor is enabled if applicable
3	Off	Free warning field
	Blue, continuous light	Warning field interrupted
4	Off	Free warning field
	Blue, continuous light	Warning field interrupted
5	Off	RES deactivated or RES activated and released
	Yellow, flashing	Protective field occupied
	Yellow, continuous light	RES activated and blocked but ready to be unlocked - protective field free and linked sensor is enabled if applicable
6	Off	Device switched off
	Red, continuous light	OSSD off
	Red, flashing	Error
	Green, continuous light	OSSD on

## Notes

### Observe intended use!

- The product may only be put into operation by competent persons.
- Only use the product in accordance with its intended use.

### WARNING! INVISIBLE LASER RADIATION – LASER CLASS 1

The device satisfies the requirements of IEC 60825-1:2007 (EN 60825-1:2007) safety regulations for a product of **laser class 1** as well as the U.S. 21 CFR 1040.10 regulations with deviations corresponding to "Laser Notice No. 50" from June 24, 2007.



- Observe the applicable statutory and local laser protection regulations.
- The device must not be tampered with and must not be changed in any way. There are no user-serviceable parts inside the device. Repairs must only be performed by Leuze electronic GmbH + Co. KG.

## Accessories

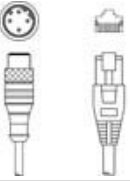
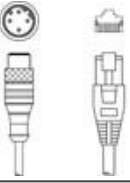
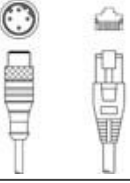
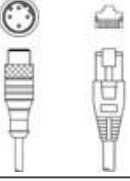
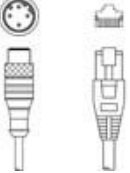
### Connection technology - Interconnection cables



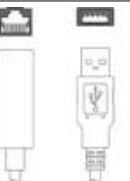

	Part no.	Designation	Article	Description
	50135080	KSS ET-M12-4A-RJ45-A-P7-020	Interconnection cable	Suitable for interface: Ethernet Connection 1: Connector, M12, Axial, Male, D-coded, 4 -pin Connection 2: RJ45 Shielded: Yes Cable length: 2,000 mm Sheathing material: PUR
	50135081	KSS ET-M12-4A-RJ45-A-P7-050	Interconnection cable	Suitable for interface: Ethernet Connection 1: Connector, M12, Axial, Male, D-coded, 4 -pin Connection 2: RJ45 Shielded: Yes Cable length: 5,000 mm Sheathing material: PUR
	50135082	KSS ET-M12-4A-RJ45-A-P7-100	Interconnection cable	Suitable for interface: Ethernet Connection 1: Connector, M12, Axial, Male, D-coded, 4 -pin Connection 2: RJ45 Shielded: Yes Cable length: 10,000 mm Sheathing material: PUR
	50135083	KSS ET-M12-4A-RJ45-A-P7-150	Interconnection cable	Suitable for interface: Ethernet Connection 1: Connector, M12, Axial, Male, D-coded, 4 -pin Connection 2: RJ45 Shielded: Yes Cable length: 15,000 mm Sheathing material: PUR
	50135084	KSS ET-M12-4A-RJ45-A-P7-300	Interconnection cable	Suitable for interface: Ethernet Connection 1: Connector, M12, Axial, Male, D-coded, 4 -pin Connection 2: RJ45 Shielded: Yes Cable length: 30,000 mm Sheathing material: PUR

### Connection technology - Adapters

	Part no.	Designation	Article	Description
	50134949	KDS ET-RJ45-A-USB3-A-P4-000	Adapter cable	Suitable for: Ethernet Number of connections: 2 Piece(s) Connection 1: RJ45 Connection 2: USB
	50134656	RSL400 M12 Adapter	Adapter	Application: Permanent installation on the Ethernet port of the RSL400 connection unit, for simple connection of an Ethernet cable to the front of the device. Number of connections: 2 Piece(s) Connection 1: Connector, M12, D-coded, 4 -pin Connection 2: Connector, M12, D-coded, 4 -pin Dimensions: 20 mm x 90.5 mm x 40 mm Color: Black

Part no.: 53800231 – RSL430-L/CU429-25 – Safety laser scanner

## Mounting technology - Mounting brackets

	Part no.	Designation	Article	Description
	53800134	BT840M	Mounting bracket	Application: Mounting on chamfered 90° corner Dimensions: 84.9 mm x 72 mm x 205.2 mm Color: Yellow, RAL 1021 Type of fastening, at system: Through-hole mounting Type of fastening, at device: Screw type Material: Metal
	53800135	BT856M	Mounting bracket	Application: Mounting on non-chamfered 90° corner Dimensions: 119 mm x 72 mm x 233.5 mm Color: Yellow, RAL 1021 Type of fastening, at system: Through-hole mounting Type of fastening, at device: Screw type Material: Metal
	53800138	BTF815-30M	Mounting bracket	Application: Bracket for floor mounting Dimensions: 217 mm x 512 mm x 295 mm Scan level height, adjustable: 75 ... 375 mm Color: Yellow, RAL 1021 Type of fastening, at system: Through-hole mounting Type of fastening, at device: Screw type Material: Metal
	53800132	BTF815M	Mounting bracket	Application: Mounting bracket for floor mounting Dimensions: 186 mm x 120 mm x 288 mm Scan level height: 150 mm Color: Yellow, RAL 1021 Type of fastening, at system: Through-hole mounting Type of fastening, at device: Screw type Material: Metal
	53800133	BTF830M	Mounting bracket	Application: Mounting bracket for floor mounting Dimensions: 186 mm x 275 mm x 288 mm Scan level height: 300 mm Color: Yellow, RAL 1021 Type of fastening, at system: Through-hole mounting Type of fastening, at device: Screw type Material: Metal

## Mounting technology - Other

	Part no.	Designation	Article	Description
	53800130	BTU800M	Mounting system	Dimensions: 54.5 mm x 90 mm x 192 mm Color: Black Type of fastening, at system: Through-hole mounting Type of fastening, at device: Screw type Material: Metal

## Start-up/diagnosis

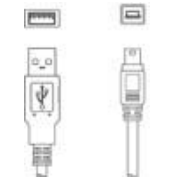
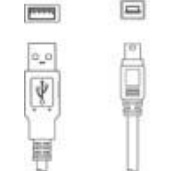

	Part no.	Designation	Article	Description
	547822	AC-MSI-USB	Accessories set	Connection 1: USB Connection 2: USB Cable length: 3,000 mm Sheathing material: PUR
	50117011	KB USB A - USB miniB	Service line	Suitable for interface: USB Connection 1: USB Connection 2: USB Shielded: Yes Cable length: 1,500 mm Sheathing material: PVC

Part no.: 53800231 – RSL430-L/CU429-25 – Safety laser scanner



## Mounting

	Part no.	Designation	Article	Description
	53800131	BTP800M	Loop guard	Dimensions: 160 mm x 169 mm Color: Black Material: Metal

## General

	Part no.	Designation	Article	Description
	430400	RS4-clean-Set1	Cleaning set	Number of cleaning cloths: 40 Piece(s) Content of cleaning fluid: 150 ml
	430410	RS4-clean-Set2	Cleaning set	Number of cleaning cloths: 120 Piece(s) Content of cleaning fluid: 1,000 ml

## Services

	Part no.	Designation	Article	Description
	S981051	CS40-I-141	Safety inspection "Safety laser scanners"	Details: Checking of a safety laser scanner application in accordance with current standards and guidelines. Inclusion of the device and machine data in a database, production of a test log per application. Conditions: It must be possible to stop the machine, support provided by customer's employees and access to the machine for Leuze employees must be ensured. Restrictions: Travel costs and accommodation expenses charged separately and according to expenditure.
	S981047	CS40-S-141	Start-up support	Details: For safety devices including stopping time measurement and initial inspection. Conditions: Devices and connection cables are already mounted, price not including travel costs and, if applicable, accommodation expenses. Restrictions: Max. 3 h., no mechanical (mounting) and electrical (wiring) work performed, no changes (attachments, wiring, programming) to third-party components in the nearby environment.