



Figure can vary

**Part no.: 53800217**  
**RSL420-S/CU416-25**  
**Safety laser scanner**



## Contents

- . Technical data
- . Dimensioned drawings
- . Electrical connection
- . Operation and display
- . Notes
- . Accessories

## Technical data

<b>Basic data</b>	
Series	RSL 400
Application	Mobile danger zone guarding Mobile side guarding Stationary access guarding Stationary danger zone guarding
<b>Functions</b>	
Functions	Dynamic contactor monitoring (EDM), selectable E-stop linkage Four-field mode Resolution, selectable
<b>Characteristic parameters</b>	
Type	3, IEC/EN 61496
SIL	2, IEC 61508
SILCL	2, IEC/EN 62061
Performance Level (PL)	d, EN ISO 13849-1
PFH <sub>D</sub>	9E-08 per hour
Mission time T <sub>M</sub>	20 years, EN ISO 13849-1
Category	3, EN ISO 13849
<b>Protective field data</b>	
Scanning angle	270 °
Minimum adjustable range	50 mm
Number of field pairs, reversible	10
Number of quads, reversible	10
Number of protective functions	1 Piece(s)
Number of independent sensor configurations	1
Diffuse reflection, min.	1.8 %
Operating range	0 ... 3 m
<b>Warning field data</b>	
Number of field pairs	10
Operating range	0 ... 20 m
Object size	150 mm x 150 mm
Diffuse reflection, min.	10 %
<b>Optical data</b>	
Light source	Laser, Infrared
Laser light wavelength	905 nm
Laser class	1, IEC/EN 60825-1:2007
Transmitted-signal shape	Pulsed
Repetition frequency	90 kHz
<b>Measurement data</b>	
Distance resolution	1 mm
Detection range	0 ... 50 m
Diffuse reflection	20 %
Angular resolution	0.1 °

<b>Electrical data</b>	
Protective circuit	Overvoltage protection
<b>Performance data</b>	
Supply voltage $U_B$	24 V, DC, -30 ... 20 %
Current consumption (without load), max.	700 mA, (use power supply unit with 3 A)
Power consumption, max.	17 W, For 24 V, plus output load
<b>Outputs</b>	
Number of safety-related switching outputs (OSSDs)	2 Piece(s)
<b>Safety-related switching outputs</b>	
Type	Safety-related switching output OSSD
Switching voltage high, min.	20.8 V
Switching voltage low, max.	2 V
Voltage type	DC
<b>Safety-related switching output 1</b>	
Assignment	Connection 1, gray wire
Switching element	Transistor, PNP
<b>Safety-related switching output 2</b>	
Assignment	Connection 1, pink wire
Switching element	Transistor, PNP

<b>Service interface</b>	
Type	Bluetooth
<b>Bluetooth</b>	
Function	Configuration/parametering
Frequency band	2,400 ... 2,483.5 MHz
Radiated transmitting power	Max. 4.5 dBm (2.82 mW), class 2
Type	USB
<b>USB</b>	
Function	Configuration/parametering
Connection	USB 2.0 mini-B, socket
Transmission speed, max.	12 Mbit/s
Cable length	≤ 5m Longer cable lengths are possible using active cables.

<b>Connection</b>	
Number of connections	2 Piece(s)
<b>Connection 1</b>	
Type of connection	Cable
Function	Machine interface
Cable length	25,000 mm
Sheathing material	PVC
Cable color	Black
Number of conductors	16 -wire
Wire cross section supply	1 mm <sup>2</sup>
Wire cross section signals	0.14 mm <sup>2</sup>

**Connection 2**

Type of connection	Connector
Function	Data interface
Thread size	M12
Type	Female
Material	Metal
No. of pins	4 -pin
Encoding	D-coded

**Cable properties**

Cable resistance, max.	15 Ω
------------------------	------

**Mechanical data**

Dimension (W x H x L)	140 mm x 149 mm x 140 mm
Housing material	Metal Plastic, Diecast zinc,
Lens cover material	Plastic/PC
Net weight	3,000 g
Housing color	Yellow, RAL 1021
Type of fastening	Mounting plate Through-hole mounting Via optional mounting device

**Operation and display**

Type of display	Alphanumeric display LED indicator
Number of LEDs	3 Piece(s)
Type of configuration	Software Sensor Studio
Operational controls	Software Sensor Studio

**Environmental data**

Ambient temperature, operation	0 ... 50 °C
Ambient temperature, storage	-20 ... 60 °C
Relative humidity (non-condensing)	15 ... 95 %

**Certifications**

Degree of protection	IP 65
Protection class	III, EN 61140
Certifications	c TÜV Süd US c UL US TÜV Süd
Test procedure for EMC in accordance with standard	DIN 40839-1/3 EN 61496-1
Test procedure for oscillation in accordance with standard	EN 60068-2-6
Test procedure for continuous shock in accordance with standard	IEC 60068-2-29
US patents	US 2016/0086469 A US 7,656,917 B US 7,696,468 B US 8,520,221 B

**Classification**

Customs tariff number	85365019
eCl@ss 8.0	27272705
eCl@ss 9.0	27272705

ETIM 5.0	EC002550
ETIM 6.0	EC002550

### Dimensioned drawings

All dimensions in millimeters

Dimensions safety laser scanner with connection unit

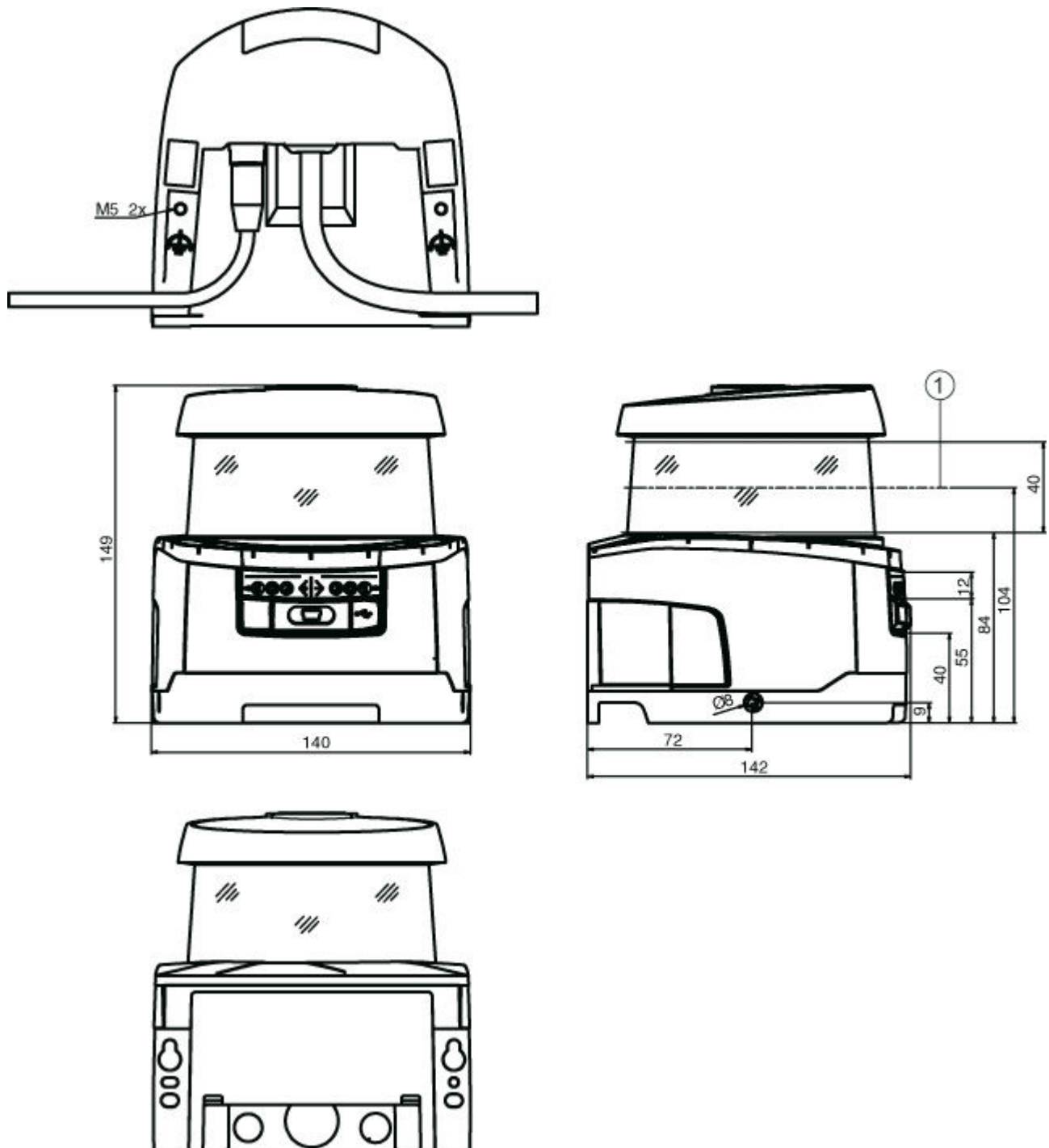

1 Scan level

Mounting dimensions safety laser scanner with connection unit

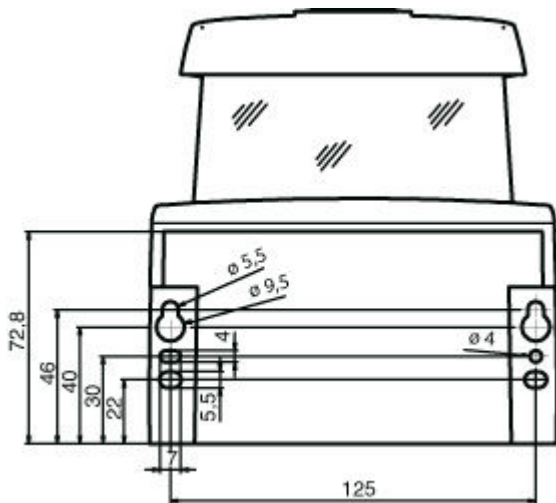

Minimum space requirements for installation and replacement of scanner unit

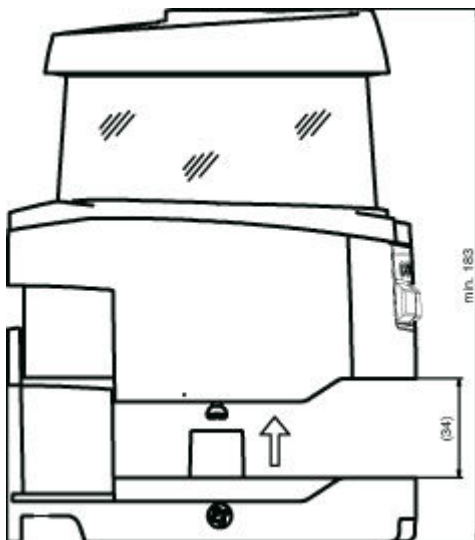

### Dimensions of scanning range

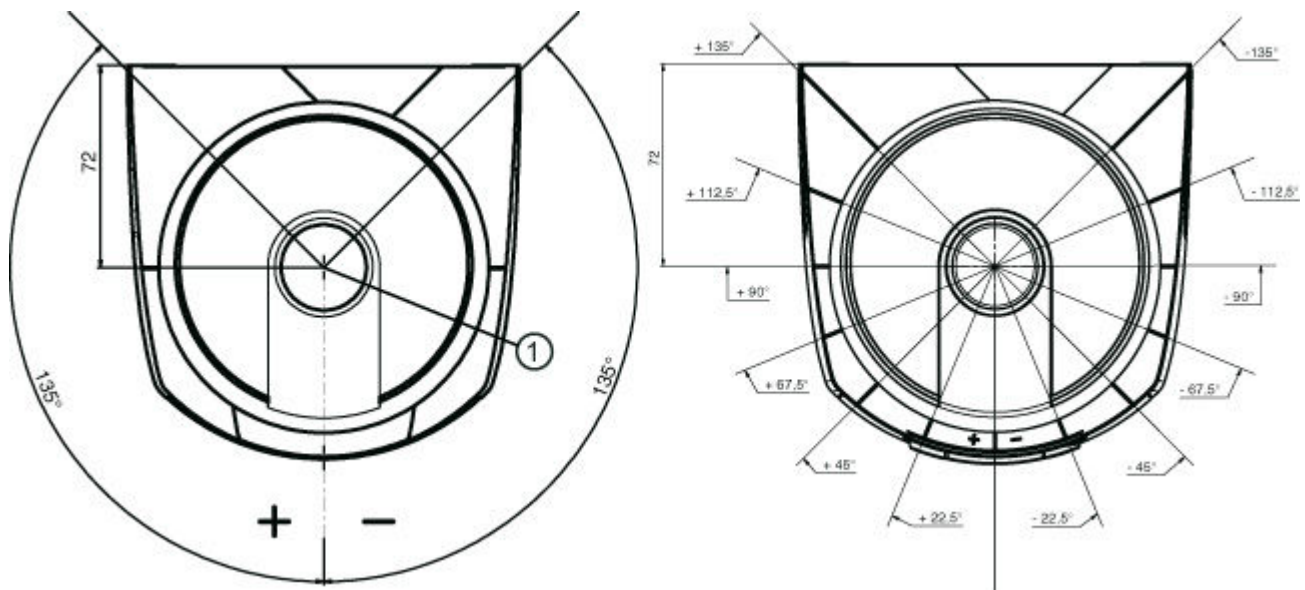

1 Reference point for distance measurement and protective field radius

### Electrical connection

Connection 1	
Type of connection	Cable
Function	Machine interface
Cable length	25,000 mm
Sheathing material	PVC
Cable color	Black
Number of conductors	16 -wire
Wire cross section	
Wire cross section supply	1 mm <sup>2</sup>
Wire cross section signals	0.14 mm <sup>2</sup>

Conductor color	Conductor assignment
White	RES1
Brown	+24V
Green	EA1
Yellow	A1
Gray	OSSDA1
Pink	OSSDA2
Blue	GND / Ground
Red	MELD
Black	F1
Violet	F2
Gray Pink	F3
Blue Red	F4
Green White	F5

Conductor color	Conductor assignment
Brown Green	SE1
White Yellow	SE2
Brown Yellow	A2

Connection 2	
Type of connection	Connector
Function	Data interface
Thread size	M12
Type	Female
Material	Metal
No. of pins	4 -pin
Encoding	D-coded
Connector housing	FE/SHIELD

Pin	Pin assignment	Conductor color
1	TD+	Yellow
2	RD+	White
3	TD-	Orange
4	RD-	Blue
5		

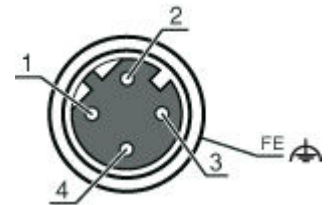

## Operation and display

### LEDs

LED	Display	Meaning
1	Off	Device switched off
	Red, continuous light	OSSD off
	Red, flashing	Error
	Green, continuous light	OSSD on
2	Off	RES deactivated or RES activated and released
	Yellow, flashing	Protective field occupied
	Yellow, continuous light	RES activated and blocked but ready to be unlocked - protective field free and linked sensor is enabled if applicable
3	Off	Free warning field
	Blue, continuous light	Warning field interrupted
4	Off	Four field mode: warning field 3 free
	Blue, continuous light	Four field mode: warning field 3 interrupted
5	Yellow, flashing	Four field mode: warning field 2 interrupted

## Notes

### Observe intended use!

- The product may only be put into operation by competent persons.
- Only use the product in accordance with its intended use.

### WARNING! INVISIBLE LASER RADIATION – LASER CLASS 1

The device satisfies the requirements of IEC 60825-1:2007 (EN 60825-1:2007) safety regulations for a product of **laser class 1** as well as the U.S. 21 CFR 1040.10 regulations with deviations corresponding to "Laser Notice No. 50" from June 24, 2007.

- Observe the applicable statutory and local laser protection regulations.
- The device must not be tampered with and must not be changed in any way.  
There are no user-serviceable parts inside the device.  
Repairs must only be performed by Leuze electronic GmbH + Co. KG.

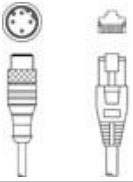
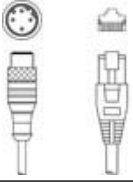
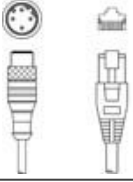
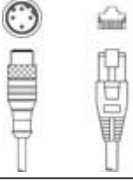
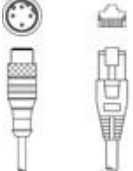

## Accessories

### Connection technology - Interconnection cables





	Part no.	Designation	Article	Description
	50135080	KSS ET-M12-4A-RJ45-A-P7-020	Interconnection cable	Suitable for interface: Ethernet Connection 1: Connector, M12, Axial, Male, D-coded, 4 -pin Connection 2: RJ45 Shielded: Yes Cable length: 2,000 mm Sheathing material: PUR
	50135081	KSS ET-M12-4A-RJ45-A-P7-050	Interconnection cable	Suitable for interface: Ethernet Connection 1: Connector, M12, Axial, Male, D-coded, 4 -pin Connection 2: RJ45 Shielded: Yes Cable length: 5,000 mm Sheathing material: PUR
	50135082	KSS ET-M12-4A-RJ45-A-P7-100	Interconnection cable	Suitable for interface: Ethernet Connection 1: Connector, M12, Axial, Male, D-coded, 4 -pin Connection 2: RJ45 Shielded: Yes Cable length: 10,000 mm Sheathing material: PUR
	50135083	KSS ET-M12-4A-RJ45-A-P7-150	Interconnection cable	Suitable for interface: Ethernet Connection 1: Connector, M12, Axial, Male, D-coded, 4 -pin Connection 2: RJ45 Shielded: Yes Cable length: 15,000 mm Sheathing material: PUR
	50135084	KSS ET-M12-4A-RJ45-A-P7-300	Interconnection cable	Suitable for interface: Ethernet Connection 1: Connector, M12, Axial, Male, D-coded, 4 -pin Connection 2: RJ45 Shielded: Yes Cable length: 30,000 mm Sheathing material: PUR

Part no.: 53800217 – RSL420-S/CU416-25 – Safety laser scanner

## Connection technology - Adapters

	Part no.	Designation	Article	Description
	50134949	KDS ET-RJ45-A-USB3-A-P4-000	Adapter cable	Suitable for: Ethernet Number of connections: 2 Piece(s) Connection 1: RJ45 Connection 2: USB
	50134656	RSL400 M12 Adapter	Adapter	Application: Permanent installation on the Ethernet port of the RSL400 connection unit, for simple connection of an Ethernet cable to the front of the device. Number of connections: 2 Piece(s) Connection 1: Connector, M12, D-coded, 4 -pin Connection 2: Connector, M12, D-coded, 4 -pin Dimensions: 20 mm x 90.5 mm x 40 mm Color: Black

## Mounting technology - Mounting brackets



	Part no.	Designation	Article	Description
	53800134	BT840M	Mounting bracket	Application: Mounting on chamfered 90° corner Dimensions: 84.9 mm x 72 mm x 205.2 mm Color: Yellow, RAL 1021 Type of fastening, at system: Through-hole mounting Type of fastening, at device: Screw type Material: Metal
	53800135	BT856M	Mounting bracket	Application: Mounting on non-chamfered 90° corner Dimensions: 119 mm x 72 mm x 233.5 mm Color: Yellow, RAL 1021 Type of fastening, at system: Through-hole mounting Type of fastening, at device: Screw type Material: Metal
	53800138	BTF815-30M	Mounting bracket	Application: Bracket for floor mounting Dimensions: 217 mm x 512 mm x 295 mm Scan level height, adjustable: 75 ... 375 mm Color: Yellow, RAL 1021 Type of fastening, at system: Through-hole mounting Type of fastening, at device: Screw type Material: Metal
	53800132	BTF815M	Mounting bracket	Application: Mounting bracket for floor mounting Dimensions: 186 mm x 120 mm x 288 mm Scan level height: 150 mm Color: Yellow, RAL 1021 Type of fastening, at system: Through-hole mounting Type of fastening, at device: Screw type Material: Metal
	53800133	BTF830M	Mounting bracket	Application: Mounting bracket for floor mounting Dimensions: 186 mm x 275 mm x 288 mm Scan level height: 300 mm Color: Yellow, RAL 1021 Type of fastening, at system: Through-hole mounting Type of fastening, at device: Screw type Material: Metal

## Mounting technology - Other

	Part no.	Designation	Article	Description
	53800130	BTU800M	Mounting system	Dimensions: 54.5 mm x 90 mm x 192 mm Color: Black Type of fastening, at system: Through-hole mounting Type of fastening, at device: Screw type Material: Metal

Part no.: 53800217 – RSL420-S/CU416-25 – Safety laser scanner

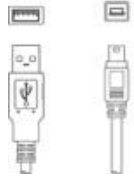

## Start-up/diagnosis

	Part no.	Designation	Article	Description
	547822	AC-MSI-USB	Accessories set	Connection 1: USB Connection 2: USB Cable length: 3,000 mm Sheathing material: PUR
	50117011	KB USB A - USB miniB	Service line	Suitable for interface: USB Connection 1: USB Connection 2: USB Shielded: Yes Cable length: 1,500 mm Sheathing material: PVC

## Mounting

	Part no.	Designation	Article	Description
	53800131	BTP800M	Loop guard	Dimensions: 160 mm x 169 mm Color: Black Material: Metal

## General

	Part no.	Designation	Article	Description
	430400	RS4-clean-Set1	Cleaning set	Number of cleaning cloths: 40 Piece(s) Content of cleaning fluid: 150 ml
	430410	RS4-clean-Set2	Cleaning set	Number of cleaning cloths: 120 Piece(s) Content of cleaning fluid: 1,000 ml

## Services

	Part no.	Designation	Article	Description
	S981051	CS40-I-141	Safety inspection "Safety laser scanners"	Details: Checking of a safety laser scanner application in accordance with current standards and guidelines. Inclusion of the device and machine data in a database, production of a test log per application. Conditions: It must be possible to stop the machine, support provided by customer's employees and access to the machine for Leuze employees must be ensured. Restrictions: Travel costs and accommodation expenses charged separately and according to expenditure.

Part no.: 53800217 – RSL420-S/CU416-25 – Safety laser scanner

	Part no.	Designation	Article	Description
	S981047	CS40-S-141	Start-up support	Details: For safety devices including stopping time measurement and initial inspection. Conditions: Devices and connection cables are already mounted, price not including travel costs and, if applicable, accommodation expenses. Restrictions: Max. 3 h., no mechanical (mounting) and electrical (wiring) work performed, no changes (attachments, wiring, programming) to third-party components in the nearby environment.