



Part no.: 50141322
ODS9L1.8/LAK-450-M12
Optical distance sensor



 IO-Link



Figure can vary

Contents

- Technical data
- Dimensioned drawings
- Electrical connection
- Diagrams
- Operation and display
- Part number code
- Notes
- Accessories

Technical data

Basic data	
Series	9
Application	Fill-level monitoring Length measurement in material cutting Object measurement
Type of scanning system	Against object
Order guide	Attention! If you need spare parts or want to switch from ODSL 9 to ODS9, please note that adapter 50140174 - KDS U-M12-5A-M12-5A-P1-003-25X is required
Special design	
Special design	Activation input Deactivation input Teach input
Optical data	
Beam profile	Collimated
Light source	Laser, Red
Laser light wavelength	650 nm
Laser class	1, IEC/EN 60825-1:2007
Transmitted-signal shape	Pulsed
Pulse duration	22,000 µs
Light-spot size [at sensor distance]	1 mm [650 mm]
Type of light-spot geometry	Round
Measurement data	
Measurement range	50 ... 450 mm
Resolution	0.1 mm
Accuracy	1 %
Reproducibility (1 sigma)	0.05 mm
Referencing	No
Optical distance measurement principle	Triangulation
Electrical data	
Protective circuit	Polarity reversal protection Short circuit protected Transient protection
Performance data	
Supply voltage U_B	18 ... 30 V, DC
Residual ripple	0 ... 15 %, From U_{B_B}
Open-circuit current	0 ... 50 mA
Inputs	
Number of digital switching inputs	1 Piece(s)
Switching inputs	
Voltage type	DC
Switching voltage	U_{B_B}
Digital switching input 1	
Function	Activation input Deactivation input Teach input Trigger

Outputs

Number of analog outputs	1 Piece(s)
Number of digital switching outputs	1 Piece(s)

Analog outputs
Analog output 1

Type	Configurable, factory setting: current
Assignment	Connection 1, pin 2

Switching outputs

Voltage type	DC
Switching voltage	High: $\geq(U_{B</sub>-2V}$ Low: $\leq 2V$

Switching output 1

Assignment	Connection 1, pin 4
Switching element	Transistor, Push-pull
Switching principle	IO-Link / light switching (PNP)/dark switching (NPN)

Timing

Response time	2 ms, Under constant ambient conditions, 90% diffuse reflection, standard measure mode
Readiness delay	300 ms

Interface

Type	IO-Link
------	---------

IO-Link

COM mode	COM3
Profile	Smart sensor profile
Frame type	2.V
Port type	A
Specification	V1.1
SIO-mode support	Yes
Process data IN	4 byte
Process data OUT	8 bit
Dual-core operating mode	Yes
Min. cycle time	COM3 = 0.5 ms

Connection

Number of connections	1 Piece(s)
-----------------------	------------

Connection 1

Type of connection	Connector, Turning, 90°
Function	Signal IN Signal OUT Voltage supply
Thread size	M12
Type	Male
Material	Plastic
No. of pins	5 -pin
Encoding	A-coded

Mechanical data

Design	Cubic
Dimension (W x H x L)	21 mm x 50 mm x 50 mm

Part no.: 50141322 – ODS9L1.8/LAK-450-M12 – Optical distance sensor

Lens cover material	Glass
Net weight	50 g
Housing color	Red
Type of fastening	Through-hole mounting Via optional mounting device

Operation and display

Type of display	LED OLED display
Number of LEDs	2 Piece(s)
Operational controls	Control buttons PC software

Environmental data

Ambient temperature, operation	-20 ... 50 °C
Ambient temperature, storage	-30 ... 70 °C

Certifications

Degree of protection	IP 67
Protection class	III
Certifications	UL

Classification

Customs tariff number	90318020
eCl@ss 8.0	27270801
eCl@ss 9.0	27270801
ETIM 5.0	EC001825
ETIM 6.0	EC001825

Dimensioned drawings

All dimensions in millimeters

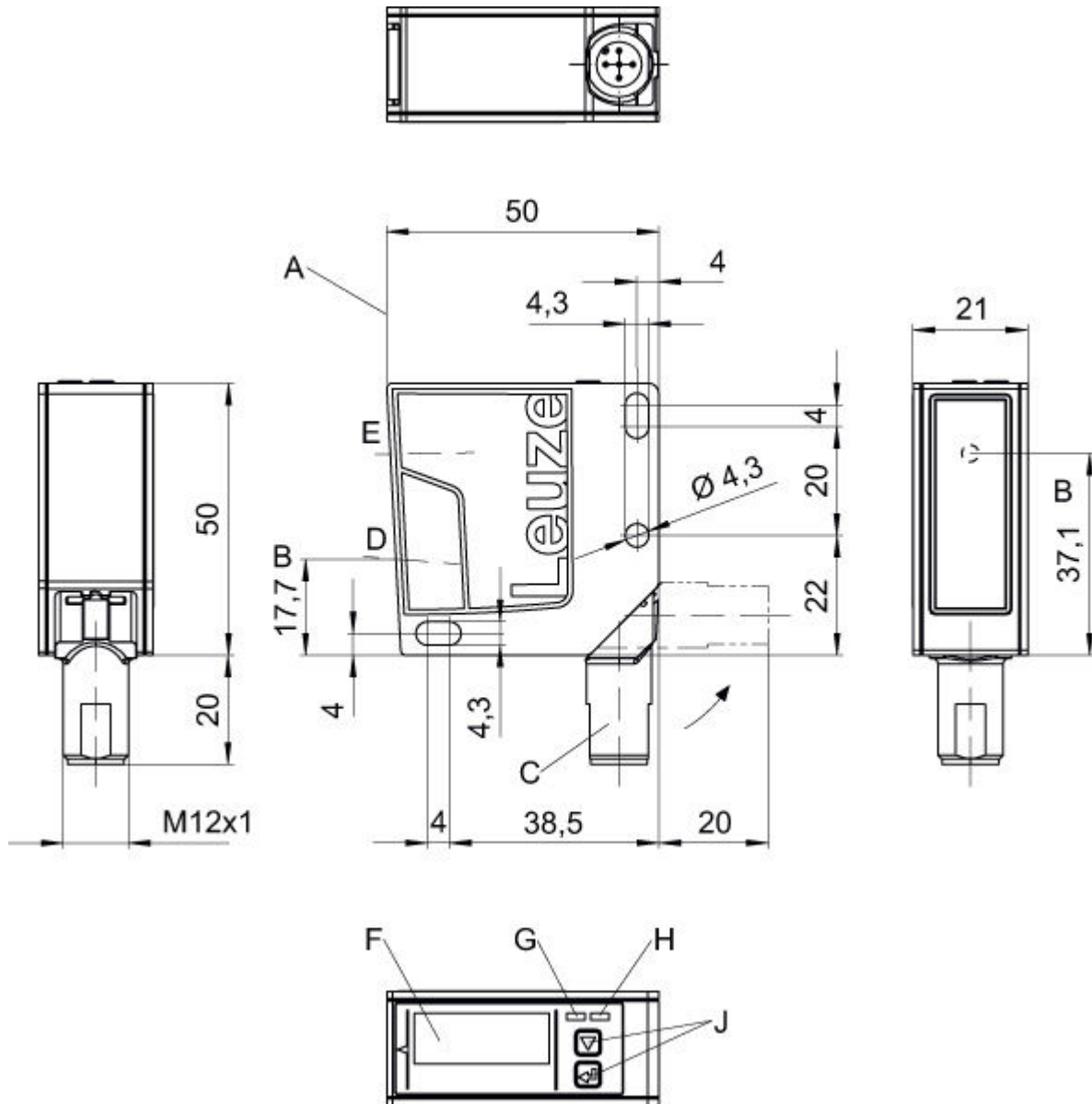

- A Reference edge for the measurement
- B Optical axis
- C Device plug M12
- D Receiver
- E Transmitter
- F Color display
- G Yellow LED
- H Green LED
- J Control buttons

Electrical connection

Connection 1	
Type of connection	Connector
Function	Signal IN Signal OUT Voltage supply
Thread size	M12
Type	Male

Connection 1	
Material	Plastic
No. of pins	5 -pin
Encoding	A-coded

Pin	Pin assignment
1	18 ... 30 V DC +
2	OUT mA / V
3	GND
4	IO-Link / OUT 1
5	multi funct

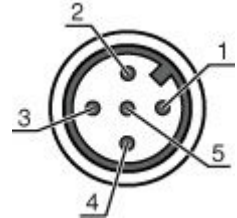

Diagrams

Characteristic curve of analog output

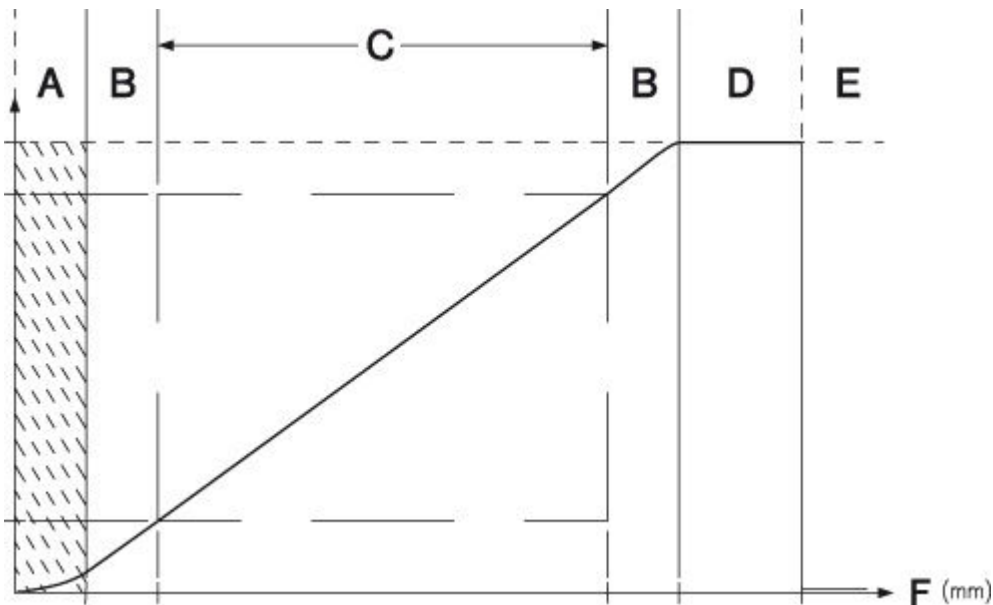

- A Area not defined
- B Linearity not defined
- C Measurement range
- D Object detected
- E No object detected (characteristic curve behavior adjustable via IO-Link)
- F Measurement distance

Accuracy of measurement of ODS 9 (measurement value * 0.01 = maximum measurement error):

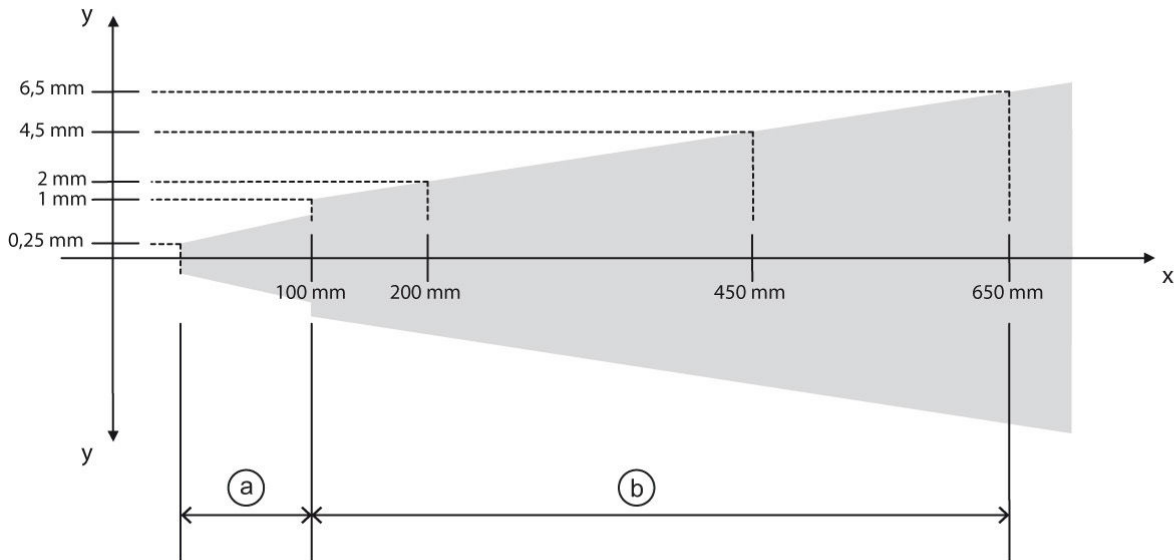

- x Measurement distance
- y Max. measurement error
- a 0.5% of measurement value
- b 1% of measurement value

Operation and display

LEDs

LED	Display	Meaning
1	Green, continuous light	Ready
2	Yellow, continuous light	Object in the measurement range

Part number code

Part designation: ODS9XX.Y/ZAB-CCC-DDD

ODS9	Operating principle: Optical distance sensor of the 9 series
XX	Light source: L2: laser class 2 L1: laser class 1
Y	Equipment: 8: OLED display and membrane keyboard for configuration
Z	Switching output/function OUT 1/IN: Pin 4 or black conductor: /L: IO-Link
A	Switching output / function OUT 2/IN: pin 2 or white conductor: A: Analog output 6: push-pull switching output, PNP light switching, NPN dark switching

Part no.: 50141322 – ODS9L1.8/LAK-450-M12 – Optical distance sensor

B	Switching output / function OUT 3/IN: Pin 5: X: pin not used 6: push-pull switching output, PNP light switching, NPN dark switching K: Multifunction input (factory setting: deactivation input)
CCC	Operating range: 100: operating range 50 ... 100 mm 200: operating range 50 ... 200 mm 450: operating range 50 ... 450 mm 650: operating range 50 ... 650 mm
DDD	Electrical connection: M12: M12 connector





Note

A list with all available device types can be found on the Leuze electronic website at www.leuze.com.





Notes
Observe intended use!

- This product is not a safety sensor and is not intended as personnel protection.
- The product may only be put into operation by competent persons.
- Only use the product in accordance with its intended use.

Accessories
Connection technology - Connection cables

	Part no.	Designation	Article	Description
	50133859	KD S-M12-5A-P1-020	Connection cable	Connection 1: Connector, M12, Axial, Female, A-coded, 5 -pin Connection 2: Open end Shielded: Yes Cable length: 2,000 mm Sheathing material: PUR
	50133860	KD S-M12-5A-P1-050	Connection cable	Connection 1: Connector, M12, Axial, Female, A-coded, 5 -pin Connection 2: Open end Shielded: Yes Cable length: 5,000 mm Sheathing material: PUR
	50133855	KD S-M12-5A-V1-020	Connection cable	Connection 1: Connector, M12, Axial, Female, A-coded, 5 -pin Connection 2: Open end Shielded: Yes Cable length: 2,000 mm Sheathing material: PVC
	50133856	KD S-M12-5A-V1-050	Connection cable	Connection 1: Connector, M12, Axial, Female, A-coded, 5 -pin Connection 2: Open end Shielded: Yes Cable length: 5,000 mm Sheathing material: PVC



Part no.: 50141322 – ODS9L1.8/LAK-450-M12 – Optical distance sensor

	Part no.	Designation	Article	Description
	50133839	KD U-M12-5A-P1-020	Connection cable	Connection 1: Connector, M12, Axial, Female, A-coded, 5 -pin Connection 2: Open end Shielded: No Cable length: 2,000 mm Sheathing material: PUR
	50133841	KD U-M12-5A-P1-050	Connection cable	Connection 1: Connector, M12, Axial, Female, A-coded, 5 -pin Connection 2: Open end Shielded: No Cable length: 5,000 mm Sheathing material: PUR
	50132077	KD U-M12-5A-V1-020	Connection cable	Connection 1: Connector, M12, Axial, Female, A-coded, 5 -pin Connection 2: Open end Shielded: No Cable length: 2,000 mm Sheathing material: PVC
	50132079	KD U-M12-5A-V1-050	Connection cable	Connection 1: Connector, M12, Axial, Female, A-coded, 5 -pin Connection 2: Open end Shielded: No Cable length: 5,000 mm Sheathing material: PVC

Connection technology - Interconnection cables

	Part no.	Designation	Article	Description
	50140174	KDS U-M12-5A-M12-5A-P1-003-25X	Interconnection cable	Connection 1: Connector, M12, Axial, Female, A-coded, 5 -pin Connection 2: Connector, M12, Axial, Male, A-coded, 5 -pin Shielded: No Cable, crossed: Connection 1, pin 2 <-> connection 2, pin 5 Cable length: 300 mm Sheathing material: PUR

Connection technology - Connectors

	Part no.	Designation	Article	Description
	50020502	KD 095-5	Connector	Connection: Connector, M12, Angled, Female, A-coded, 5 -pin
	50020501	KD 095-5A	Connector	Connection: Connector, M12, Axial, Female, A-coded, 5 -pin

Part no.: 50141322 – ODS9L1.8/LAK-450-M12 – Optical distance sensor

Mounting technology - Mounting brackets





	Part no.	Designation	Article	Description
	50118543	BT 300M.5	Mounting bracket	Design of mounting device: Angle, L-shape Fastening, at system: Through-hole mounting Mounting bracket, at device: Screw type Type of mounting device: Adjustable Material: Stainless steel

Mounting technology - Rod mounts

	Part no.	Designation	Article	Description
	50117253	BTU 300M-D10	Mounting system	Contains: 2x M4 x 25 screw, 2x M4 x 20 screw, 4x position washers Design of mounting device: Mounting system Fastening, at system: For 10 mm rod, Sheet-metal mounting Mounting bracket, at device: Screw type Type of mounting device: Clampable, Adjustable, Turning, 360° Material: Metal
	50117252	BTU 300M-D12	Mounting system	Contains: 2x M4 x 25 screw, 2x M4 x 20 screw, 4x position washers Design of mounting device: Mounting system Fastening, at system: For 12 mm rod, Sheet-metal mounting Mounting bracket, at device: Screw type Type of mounting device: Clampable, Adjustable, Turning, 360° Material: Metal
	50117251	BTU 300M-D14	Mounting system	Contains: 2x M4 x 25 screw, 2x M4 x 20 screw, 4x position washers Design of mounting device: Mounting system Fastening, at system: For 14 mm rod, Sheet-metal mounting Mounting bracket, at device: Screw type Type of mounting device: Clampable, Adjustable, Turning, 360° Material: Metal
	50120425	BTU 300M.5-D12	Mounting system	Contains: 2x M4 x 25 screw, 2x M4 x 20 screw, 2x position washers, 2x M4 mounting nut Design of mounting device: Mounting system Fastening, at system: For 12 mm rod, Sheet-metal mounting Mounting bracket, at device: Screw type Type of mounting device: Clampable, Adjustable, Turning, 360° Material: Stainless steel
	50132605	BTU 360-D18	Rod mounting	Contains: 2x M4 x 30 screw, 2x M4 x 20 screw, 2x M4 mounting nut Design of mounting device: Mounting system Fastening, at system: For 18 mm rod Mounting bracket, at device: Screw type Type of mounting device: Turning, 360°, Adjustable, Clampable Material: Plastic, Metal
	50132606	BTU 360-D30	Rod mounting	Contains: 2x M4 x 30 screw, 2x M4 x 20 screw, 2x M4 mounting nut Design of mounting device: Mounting system Fastening, at system: For 30 mm rod Mounting bracket, at device: Screw type Type of mounting device: Turning, 360°, Adjustable, Clampable Material: Plastic, Metal
	50128379	BTU 460M-D10	Mounting system	Design of mounting device: Mounting system Fastening, at system: For 10 mm rod Mounting bracket, at device: Screw type Type of mounting device: Adjustable, Turning, 360° Material: Metal

Part no.: 50141322 – ODS9L1.8/LAK-450-M12 – Optical distance sensor

	Part no.	Designation	Article	Description
	50128380	BTU 460M-D12	Mounting system	Design of mounting device: Mounting system Fastening, at system: For 12 mm rod Mounting bracket, at device: Screw type Type of mounting device: Adjustable, Turning, 360° Material: Metal

	Part no.	Designation	Article	Description
	50131483	MD 248i-12-8K/ L4-2R2K	Distribution box	Type: IO-Link master Supply voltage: 18 ... 30 V Switching outputs for each sensor connection: 1 Piece(s) Switching output: Transistor, PNP / NPN reversible Interface: PROFINET, IO-Link Connections: 14 Piece(s) Sensor connections: 8 Piece(s) Connections for voltage supply: 4 Piece(s) Interface connections: 2 Piece(s) Degree of protection: IP 67
	50131485	MD 258i-12-8K/ L4-2R2K	Distribution box	Type: IO-Link master Supply voltage: 18 ... 30 V Switching outputs for each sensor connection: 1 Piece(s) Switching output: Transistor, PNP / NPN reversible Interface: EtherNet IP, IO-Link, Modbus TCP Connections: 14 Piece(s) Sensor connections: 8 Piece(s) Connections for voltage supply: 4 Piece(s) Interface connections: 2 Piece(s) Degree of protection: IP 67
	50131482	MD 748i-11-42/ L5-2222	Distribution box	Type: IO-Link master Supply voltage: 18 ... 30 V Switching outputs for each sensor connection: 1 Piece(s) Switching output: Transistor, PNP / NPN reversible Interface: PROFINET, IO-Link Connections: 8 Piece(s) Sensor connections: 4 Piece(s) Connections for voltage supply: 2 Piece(s) Interface connections: 2 Piece(s) Degree of protection: IP 67
	50131484	MD 758i-11-42/ L5-2222	Distribution box	Type: IO-Link master Supply voltage: 18 ... 30 V Switching outputs for each sensor connection: 1 Piece(s) Switching output: Transistor, PNP / NPN reversible Interface: EtherNet IP, IO-Link, Modbus TCP Connections: 8 Piece(s) Sensor connections: 4 Piece(s) Connections for voltage supply: 2 Piece(s) Interface connections: 2 Piece(s) Degree of protection: IP 67
	50121098	SET MD12-US2-IL1.1 + Zub.	Diagnostics set	Interface: USB Connections: 2 Piece(s) Degree of protection: IP 20