



Part no.: 50138083
BCL 308i R1 J 100 D H
Stationary bar code reader



Ethernet



Figure can vary

Contents

- Technical data
- Dimensioned drawings
- Electrical connection
- Diagrams
- Operation and display
- Part number code
- Notes
- Accessories

Technical data

Basic data	
Series	BCL 300i
Special design	
Special design	Heating
Functions	
Functions	Code fragment technology Alignment mode AutoConfig Heating AutoReflAct LED indicator AutoControl Reference code comparison
Characteristic parameters	
MTTF	110 years
Read data	
Code types, readable	GS1 Databar Omnidirectional GS1 Databar Expanded Codabar Code 128 GS1 Databar Limited Code 93 Code 39 UPC 2/5 Interleaved EAN 8/13
Scanning rate, typical	1,000 scans/s
Bar codes per reading gate, max. number	64 Piece(s)
Optical data	
Reading distance	100 ... 600 mm
Light source	Laser, Red
Laser light wavelength	655 nm
Laser class	2, IEC/EN 60825-1:2007
Transmitted-signal shape	Continuous
Usable opening angle (reading field opening)	60 °
Module size	0.5 ... 0.8 mm
Reading method	Raster scanner with deflecting mirror
Beam deflection	By means of rotating polygon mirror wheel + deflecting mirror
Light beam exit	Lateral with deflecting mirror
Raster (number of lines)	8 Piece(s)
Scanning field at scanner distance of 100 mm	17 mm
Scanning field at scanner distance of 200 mm	27 mm
Scanning field at scanner distance of 300 mm	38 mm
Scanning field at scanner distance of 400 mm	48 mm
Electrical data	
Protective circuit	Polarity reversal protection

Part no.: 50138083 – BCL 308i R1 J 100 D H – Stationary bar code reader
Performance data

Supply voltage U_B	18 ... 30 V, DC
Power consumption, max.	45 W

Inputs/outputs selectable

Output current, max.	60 mA
Number of inputs/outputs selectable	2 Piece(s)
Input current, max.	8 mA

Interface

Type	Ethernet
------	----------

Ethernet

Architecture	Server Client
Address assignment	Manual address assignment DHCP
Transmission speed	10 Mbit/s 100 Mbit/s
Function	Process
Switch functionality	Integrated
Transmission protocol	TCP/IP , UDP

Service interface

Type	USB
------	-----

USB

Function	Configuration via software
----------	----------------------------

Connection

Number of connections	1 Piece(s)
-----------------------	------------

Connection 1

Type of connection	Plug connector
Function	PWR / SW IN/OUT BUS OUT Data interface BUS IN Connection to device Service interface
No. of pins	32 -pin
Type	Male

Mechanical data

Design	Cubic
Dimension (W x H x L)	103 mm x 44 mm x 96 mm
Housing material	Metal, Diecast aluminum
Lens cover material	Glass
Net weight	350 g
Housing color	Black Red
Type of fastening	Dovetail grooves Via optional mounting device Fastening on back

Operation and display

Type of display	Monochromatic graphic display, 128 x 32 pixels LED
-----------------	-------------------------------------------------------

Part no.: 50138083 – BCL 308i R1 J 100 D H – Stationary bar code reader

Number of LEDs	2 Piece(s)
Type of configuration	Via web browser

Environmental data

Ambient temperature, operation	-35 ... 40 °C
Ambient temperature, storage	-20 ... 70 °C
Relative humidity (non-condensing)	0 ... 90 %

Certifications

Degree of protection	IP 65
Protection class	III
Certifications	c UL US
Test procedure for EMC in accordance with standard	EN 61000-4-2, -3, -4, -6 EN 55022
Test procedure for shock in accordance with standard	IEC 60068-2-27, test Ea
Test procedure for continuous shock in accordance with standard	IEC 60068-2-29, test Eb
Test procedure for vibration in accordance with standard	IEC 60068-2-6, test Fc

Classification

Customs tariff number	84719000
eCl@ss 8.0	27280102
eCl@ss 9.0	27280102
ETIM 5.0	EC002550
ETIM 6.0	EC002550

Dimensioned drawings

All dimensions in millimeters

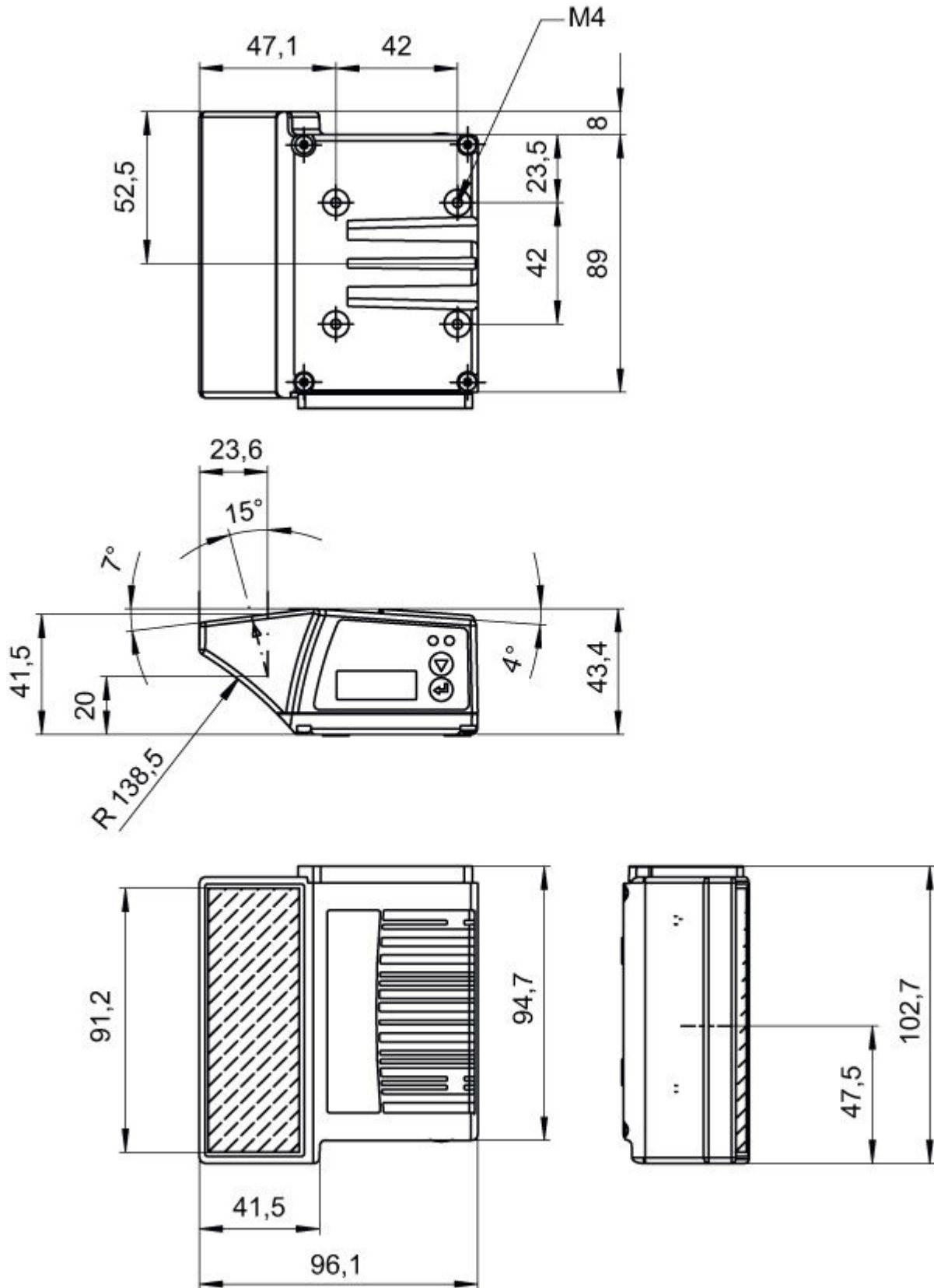

Electrical connection

Connection 1	
Type of connection	Plug connector
Function	PWR / SW IN/OUT BUS OUT Data interface BUS IN Connection to device Service interface
No. of pins	32 -pin
Type	Male

Diagrams

Reading field curve

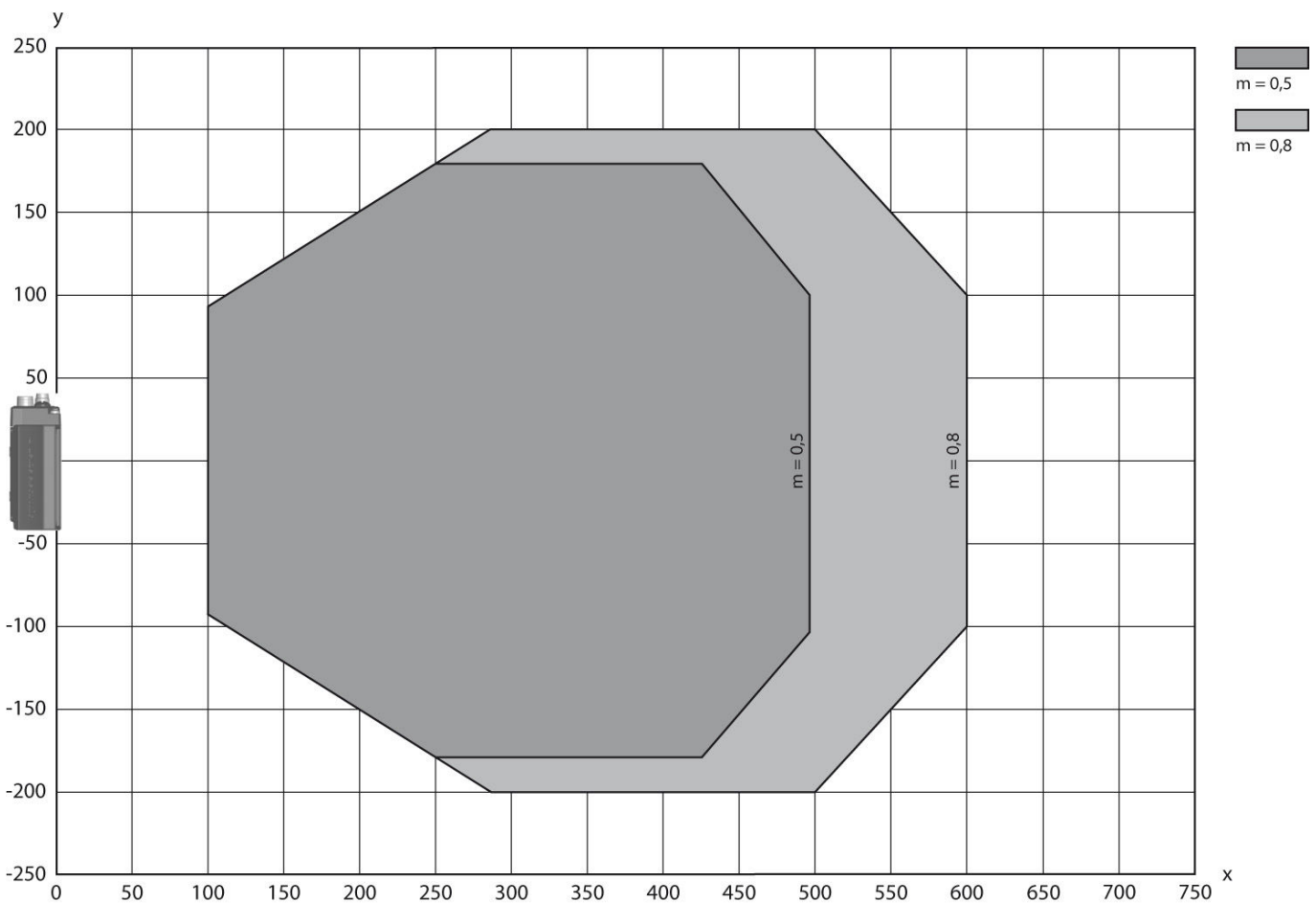

x Reading field distance [mm]
y Reading field width [mm]

Operation and display

LEDs

LED	Display	Meaning	
1	PWR	Green, flashing	Device ok, initialization phase
		Green, continuous light	Device OK
		Green, briefly off - on	Reading successful
		green, briefly off - briefly red - on	Reading not successful
		Orange, continuous light	Service mode
		Red, flashing	Device OK, warning set
		Red, continuous light	Error, device error
2	NET	Green, flashing	Initialization
		Green, continuous light	Bus operation ok
		Red, flashing	Communication error
		Red, continuous light	Bus error

Part number code

Part designation: **BCL XXXX YYZ AAA BB**

BCL	Operating principle: BCL: bar code reader
XXXX	Series/interface (integrated fieldbus technology): 300i: RS 232 / RS 422 (stand-alone) 301i: RS 485 (multiNet slave) 304i: PROFIBUS DP 308i: EtherNet TCP/IP, UDP 348i: PROFINET RT 358i: EtherNet/IP
YY	Scanning principle: S: line scanner (single line) R1: line scanner (raster) O: oscillating-mirror scanner (oscillating mirror)
Z	Optics: N: High Density (close) M: Medium Density (medium distance) F: Low Density (remote) L: Long Range (very large distances) J: ink-jet (depending on the application)
AAA	Beam exit: 100: lateral 102: front
BB	Special equipment: D: with display H: with heating DH: optionally with display and heating P: plastic exit window

Notes

Observe intended use!
<ul style="list-style-type: none"> • This product is not a safety sensor and is not intended as personnel protection. • The product may only be put into operation by competent persons. • Only use the product in accordance with its intended use.

WARNING! LASER RADIATION – LASER CLASS 2

Never look directly into the beam!

The device satisfies the requirements of IEC 60825-1:2007 (EN 60825-1:2007) safety regulations for a product of **laser class 2** as well as the U.S. 21 CFR 1040.10 regulations with deviations corresponding to "Laser Notice No. 50" from June 24, 2007.

- Never look directly into the laser beam or in the direction of reflected laser beams! If you look into the beam path over a longer time period, there is a risk of injury to the retina.
- Do not point the laser beam of the device at persons!
- Interrupt the laser beam using a non-transparent, non-reflective object if the laser beam is accidentally directed towards a person.
- When mounting and aligning the device, avoid reflections of the laser beam off reflective surfaces!
- CAUTION! Use of controls or adjustments or performance of procedures other than specified herein may result in hazardous light exposure.
- Observe the applicable statutory and local laser protection regulations.
- The device must not be tampered with and must not be changed in any way.
There are no user-serviceable parts inside the device.
Repairs must only be performed by Leuze electronic GmbH + Co. KG.

NOTE



Affix laser information and warning signs!

Laser information and warning signs are affixed to the device. In addition, self-adhesive laser information and warning signs (stick-on labels) are supplied in several languages.







- Affix the laser information sheet to the device in the language appropriate for the place of use. When using the device in the US, use the stick-on label with the "Complies with 21 CFR 1040.10" note.
- Affix the laser information and warning signs near the device if no signs are attached to the device (e.g. because the device is too small) or if the attached laser information and warning signs are concealed due to the installation position.
- Affix the laser information and warning signs so that they are legible without exposing the reader to the laser radiation of the device or other optical radiation.

Accessories

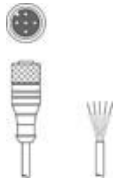
Connection technology - Connection cables

	Part no.	Designation	Article	Description
	50132077	KD U-M12-5A-V1-020	Connection cable	Connection 1: Connector, M12, Axial, Female, A-coded, 5 -pin Connection 2: Open end Shielded: No Cable length: 2,000 mm Sheathing material: PVC
	50132079	KD U-M12-5A-V1-050	Connection cable	Connection 1: Connector, M12, Axial, Female, A-coded, 5 -pin Connection 2: Open end Shielded: No Cable length: 5,000 mm Sheathing material: PVC
	50132080	KD U-M12-5A-V1-100	Connection cable	Connection 1: Connector, M12, Axial, Female, A-coded, 5 -pin Connection 2: Open end Shielded: No Cable length: 10,000 mm Sheathing material: PVC

Part no.: 50138083 – BCL 308i R1 J 100 D H – Stationary bar code reader

	Part no.	Designation	Article	Description
	50132432	KD U-M12-5A-V1-300	Connection cable	Connection 1: Connector, M12, Axial, Female, A-coded, 5 -pin Connection 2: Open end Shielded: No Cable length: 30,000 mm Sheathing material: PVC
	50135073	KS ET-M12-4A-P7-020	Connection cable	Suitable for interface: Ethernet Connection 1: Connector, M12, Axial, Male, D-coded, 4 -pin Connection 2: Open end Shielded: Yes Cable length: 2,000 mm Sheathing material: PUR
	50135074	KS ET-M12-4A-P7-050	Connection cable	Suitable for interface: Ethernet Connection 1: Connector, M12, Axial, Male, D-coded, 4 -pin Connection 2: Open end Shielded: Yes Cable length: 5,000 mm Sheathing material: PUR
	50135075	KS ET-M12-4A-P7-100	Connection cable	Suitable for interface: Ethernet Connection 1: Connector, M12, Axial, Male, D-coded, 4 -pin Connection 2: Open end Shielded: Yes Cable length: 10,000 mm Sheathing material: PUR
	50135076	KS ET-M12-4A-P7-150	Connection cable	Suitable for interface: Ethernet Connection 1: Connector, M12, Axial, Male, D-coded, 4 -pin Connection 2: Open end Shielded: Yes Cable length: 15,000 mm Sheathing material: PUR
	50135077	KS ET-M12-4A-P7-300	Connection cable	Suitable for interface: Ethernet Connection 1: Connector, M12, Axial, Male, D-coded, 4 -pin Connection 2: Open end Shielded: Yes Cable length: 30,000 mm Sheathing material: PUR

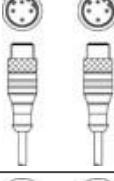
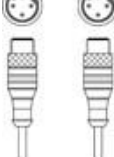

Connection technology - Interconnection cables

	Part no.	Designation	Article	Description
	50117011	KB USB A - USB miniB	Service line	Suitable for interface: USB Connection 1: USB Connection 2: USB Shielded: Yes Cable length: 1,500 mm Sheathing material: PVC
	50137077	KSS ET-M12-4A-M12-4A-P7-020	Interconnection cable	Suitable for interface: Ethernet Connection 1: Connector, M12, Axial, Male, D-coded, 4 -pin Connection 2: Connector, M12, Axial, Male, D-coded, 4 -pin Shielded: Yes Cable length: 1,000 mm Sheathing material: PUR
	50137078	KSS ET-M12-4A-M12-4A-P7-050	Interconnection cable	Suitable for interface: Ethernet Connection 1: Connector, M12, Axial, Male, D-coded, 4 -pin Connection 2: Connector, M12, Axial, Male, D-coded, 4 -pin Shielded: Yes Cable length: 1,000 mm Sheathing material: PUR

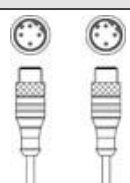
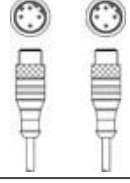
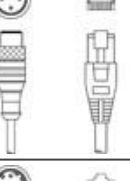
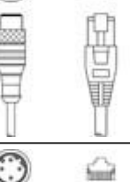
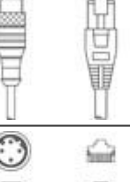
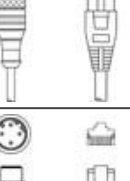
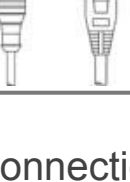
Part no.: 50138083 – BCL 308i R1 J 100 D H – Stationary bar code reader

	Part no.	Designation	Article	Description
	50137079	KSS ET-M12-4A-M12-4A-P7-100	Interconnection cable	Suitable for interface: Ethernet Connection 1: Connector, M12, Axial, Male, D-coded, 4 -pin Connection 2: Connector, M12, Axial, Male, D-coded, 4 -pin Shielded: Yes Cable length: 10,000 mm Sheathing material: PUR
	50137080	KSS ET-M12-4A-M12-4A-P7-150	Interconnection cable	Suitable for interface: Ethernet Connection 1: Connector, M12, Axial, Male, D-coded, 4 -pin Connection 2: Connector, M12, Axial, Male, D-coded, 4 -pin Shielded: Yes Cable length: 15,000 mm Sheathing material: PUR
	50135080	KSS ET-M12-4A-RJ45-A-P7-020	Interconnection cable	Suitable for interface: Ethernet Connection 1: Connector, M12, Axial, Male, D-coded, 4 -pin Connection 2: RJ45 Shielded: Yes Cable length: 2,000 mm Sheathing material: PUR
	50135081	KSS ET-M12-4A-RJ45-A-P7-050	Interconnection cable	Suitable for interface: Ethernet Connection 1: Connector, M12, Axial, Male, D-coded, 4 -pin Connection 2: RJ45 Shielded: Yes Cable length: 5,000 mm Sheathing material: PUR
	50135082	KSS ET-M12-4A-RJ45-A-P7-100	Interconnection cable	Suitable for interface: Ethernet Connection 1: Connector, M12, Axial, Male, D-coded, 4 -pin Connection 2: RJ45 Shielded: Yes Cable length: 10,000 mm Sheathing material: PUR
	50135083	KSS ET-M12-4A-RJ45-A-P7-150	Interconnection cable	Suitable for interface: Ethernet Connection 1: Connector, M12, Axial, Male, D-coded, 4 -pin Connection 2: RJ45 Shielded: Yes Cable length: 15,000 mm Sheathing material: PUR
	50135084	KSS ET-M12-4A-RJ45-A-P7-300	Interconnection cable	Suitable for interface: Ethernet Connection 1: Connector, M12, Axial, Male, D-coded, 4 -pin Connection 2: RJ45 Shielded: Yes Cable length: 30,000 mm Sheathing material: PUR





Connection technology - Connectors

	Part no.	Designation	Article	Description
	50108991	D-ET1	Connector	Suitable for interface: Ethernet Connection: RJ45
	50020501	KD 095-5A	Connector	Connection: Connector, M12, Axial, Female, A-coded, 5 -pin

Part no.: 50138083 – BCL 308i R1 J 100 D H – Stationary bar code reader

	Part no.	Designation	Article	Description
	50112155	S-M12A-ET	Connector	Suitable for interface: Ethernet Connection: Connector, M12, Axial, Male, D-coded, 4 -pin

Connection technology - Connection boxes

	Part no.	Designation	Article	Description
	50131255 *	ME 308 103	Connection unit	Suitable for: BCL 308i Suitable for interface: Ethernet Number of connections: 4 Piece(s) Connection: Cable with connector, M12, 900 mm
	50131254 *	ME 308 104	Connection unit	Suitable for: BCL 308i Suitable for interface: Ethernet Number of connections: 5 Piece(s) Connection: Cable with connector, M12, 900 mm
	50116466 *	MK 308	Connection unit	Suitable for: BCL 308i Suitable for interface: Ethernet Number of connections: 4 Piece(s) Connection: Terminal
	50114823 *	MS 308	Connection unit	Suitable for: BCL 308i Suitable for interface: Ethernet Number of connections: 4 Piece(s) Connection: Connector, M12

* Necessary accessories, please order separately

Connection technology - Adapters



	Part no.	Designation	Article	Description
	50109832	KDS ET-M12 / RJ45 W-4P	Adapter	Suitable for: Ethernet Number of connections: 2 Piece(s) Connection 1: Connector, M12, Angled, Female, D-coded, 4 -pin Connection 2: RJ45

Mounting technology - Mounting brackets



	Part no.	Designation	Article	Description
	50121433	BT 300 W	Mounting device	Contains: 4x M4 x 10 screw, 4x position washers, 4x lock washers Design of mounting device: Angle, L-shape Fastening, at system: Through-hole mounting Mounting bracket, at device: Screw type Type of mounting device: Adjustable Material: Metal

Part no.: 50138083 – BCL 308i R1 J 100 D H – Stationary bar code reader

Mounting technology - Rod mounts

	Part no.	Designation	Article	Description
	50121434	BT 300 - 1	Mounting device	Contains: 4x M4 x 10 screw, 4x position washers, 4x lock washers Design of mounting device: Mounting system Fastening, at system: For 12 mm rod, For 14 mm rod, For 16 mm rod Mounting bracket, at device: Screw type Type of mounting device: Turning, 360°, Adjustable Material: Metal
	50027375	BT 56	Mounting device	Functions: Static applications Design of mounting device: Mounting system Fastening, at system: For 16 mm rod, For 18 mm rod, For 20 mm rod Mounting bracket, at device: Clampable Material: Metal Tightening torque of the clamping jaws: 8 N·m
	50121435	BT 56 - 1	Mounting device	Functions: Static applications Design of mounting device: Mounting system Fastening, at system: For 12 mm rod, For 14 mm rod, For 16 mm rod Mounting bracket, at device: Clampable Material: Metal Tightening torque of the clamping jaws: 8 N·m

Mounting technology - Other

	Part no.	Designation	Article	Description
	50111224	BT 59	Mounting bracket	Fastening, at system: Groove mounting Mounting bracket, at device: Clampable Material: Metal
	50124941	BTU 0300M-W	Mounting device	Fastening, at system: Through-hole mounting Mounting bracket, at device: Clampable, Groove mounting Material: Metal





Reflective tapes for standard applications

	Part no.	Designation	Article	Description
	50106119	REF 4-A-100x100	Reflective tape	Design: Rectangular Reflective surface: 100 mm x 100 mm Material: Plastic Chemical designation of the material: PMMA Fastening: Self-adhesive

General

	Part no.	Designation	Article	Description
	50120731	Housing BCL 300i V2A	Protective housing	Suitable for: BCL 3xxi series bar code reader, deflecting mirror Length: 63 mm Housing material: Stainless steel Standard designation, housing: V2A Lens cover material: Glass Degree of protection: IP 67, IP 69K

Services

	Part no.	Designation	Article	Description
	S981020	CS30-E-212	Hourly rate for "Configuration"	Details: Compilation of the application data, selection and suggestion of suitable sensor system, drawing prepared as assembly sketch. Conditions: Completed questionnaire or project specifications with a description of the application have been provided. Restrictions: Travel and accommodation charged separately and according to expenditure.
	S981014	CS30-S-110	Start-up support	Details: Performed at location of customer's choosing, duration: max. 10 hours. Conditions: Devices and connection cables are already mounted, price not including travel costs and, if applicable, accommodation expenses. Restrictions: No mechanical (mounting) and electrical (wiring) work performed, no changes (attachments, wiring, programming) to third-party components in the nearby environment.
	S981019	CS30-T-110	Product training	Details: Location and content to be agreed upon, duration: max. 10 hours. Conditions: Price not including travel costs and, if applicable, accommodation expenses. Restrictions: Travel costs and accommodation expenses charged separately and according to expenditure.
	S981021	CS30-V-212	Hourly rate for "Bar code qualification"	Details: REA evaluation with creation of a test report, evaluation of the code quality. Conditions: Original bar codes to be provided by the client.