



Figure can vary

Part no.: 50137573
DCR 248i FIX-L1-102-R3-G
Stationary 2D-code reader



RS232

RS422

Ethernet



Contents

- Technical data
- Dimensioned drawings
- Electrical connection
- Diagrams
- Operation and display
- Part number code
- Notes
- Accessories

Technical data

Basic data	
Series	DCR 200i
Chip	CMOS
Functions	
Software functions	Reading of 1D codes Reading of 2D codes
Read data	
Code types, readable	2/5 Interleaved Aztec Codabar Code 128 Code 32 Code 39 Code 93 Data Matrix Code EAN 128 EAN 8/13 GS1 Databar GS1 Databar Omnidirectional GS1 Databar QR code GS1 Databar Stacked PDF417 Pharma Code QR code UPC
Optical data	
Reading distance	50 ... 800 mm
Light source	LED, Red
Transmitted-signal shape	Pulsed
Camera resolution, horizontal	1,280 px
Camera resolution, vertical	960 px
Module size	0.35 ... 1 mm
Electronic shutter speed	0.068 ... 5 ms
Camera type	Monochrome
Electrical data	
Protective circuit	Polarity reversal protection Short circuit protected
Performance data	
Supply voltage U_B	18 ... 30 V, DC
Average power consumption	8 W
Inputs	
Number of digital switching inputs	1 Piece(s)
Switching inputs	
Voltage type	DC

Outputs	
Number of digital switching outputs	1 Piece(s)
Switching outputs	
Voltage type	DC
Switching current, max.	100 mA
Switching output 1	
Switching element	MOSFET semiconductor,
Switching principle	+24 V switching
Inputs/outputs selectable	
Number of inputs/outputs selectable	2 Piece(s)
Voltage type, outputs	DC
Voltage type, inputs	DC

Interface	
Type	RS 232, RS 422, Ethernet, PROFINET
RS 232	
Function	Process
Transmission speed	4,800 ... 115,200 Bd
Data format	Adjustable
Start bit	1
Data bit	8 data bits
Stop bit	1 stop bit
Parity	None
Transmission protocol	<STX><data><CR><LF>
Data encoding	ASCII Binary
RS 422	
Function	Process
Transmission speed	4,800 ... 115,200 Bd
Data format	Adjustable
Start bit	1
Data bit	7, 8 data bits
Stop bit	1, 2 stop bits
Parity	Adjustable
Transmission protocol	Adjustable
Data encoding	ASCII Binary
Ethernet	
Architecture	Client Server
Address assignment	DHCP Manual address assignment
Transmission speed	10 / 100 Mbit/s
Function	Process
Switch functionality	None
Transmission protocol	TCP/IP , UDP
Profinet	
Function	Process
Conformance class	B
Protocol	PROFINET RT
Transmission speed	100 Mbit/s

Service interface

Type

Ethernet
Connection

Number of connections 2 Piece(s)

Connection 1

Type of connection	Connector
Function	Data interface Signal IN Signal OUT Voltage supply
Thread size	M12
Type	Male
Material	Metal
No. of pins	12 -pin
Encoding	A-coded

Connection 2

Type of connection	Connector
Function	Configuration interface Data interface
Thread size	M12
Type	Female
Material	Metal
No. of pins	4 -pin
Encoding	D-coded

Mechanical data

Design	Cubic
Dimension (W x H x L)	43 mm x 61 mm x 44 mm
Housing material	Metal Plastic, Diecast aluminum, PC
Lens cover material	Glass
Net weight	120 g
Housing color	Silver
Type of fastening	Mounting thread Via optional mounting device

Operation and display

Type of display	LED
Number of LEDs	10 Piece(s)
Type of configuration	Configuration codes Teach-in Via web browser
Operational controls	Button(s)
Function of the operational control	Adjustment mode Auto-setup Trigger

Environmental data

Ambient temperature, operation	0 ... 45 °C
Ambient temperature, storage	-20 ... 70 °C
Relative humidity (non-condensing)	90 %

Certifications

Degree of protection	IP 65
Protection class	III
Certifications	c UL US
Test procedure for EMC in accordance with standard	EN 61000-6-2 EN 61000-6-4
Test procedure for continuous shock in accordance with standard	IEC 60068-2-29, test Eb
Test procedure for vibration in accordance with standard	IEC 60068-2-6, test Fc

Classification

Customs tariff number	84719000
eCl@ss 8.0	27280103
eCl@ss 9.0	27280103
ETIM 5.0	EC002999
ETIM 6.0	EC002999

Dimensioned drawings

All dimensions in millimeters

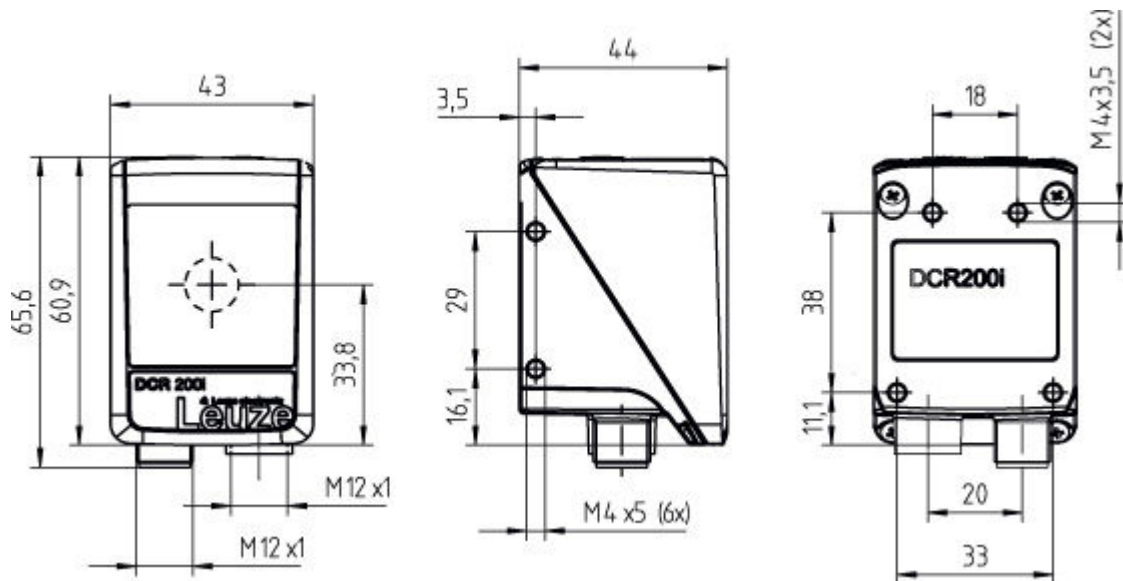

Electrical connection

Connection 1	PWR / SWIO
Type of connection	Connector
Function	Data interface Signal IN Signal OUT Voltage supply
Thread size	M12
Type	Male
Material	Metal
No. of pins	12 -pin

Part no.: 50137573 – DCR 248i FIX-L1-102-R3-G – Stationary 2D-code reader

Connection 1	PWR / SWIO
Encoding	A-coded

Pin	Pin assignment
1	V+
2	GNDIN
3	SWIN 1
4	SWOUT 2
5	FE
6	GND RS 232 / GND RS 422
7	Rx-
8	Tx-
9	RxD/Rx+
10	TxD/Tx+
11	SWIO 3
12	SWIO 4

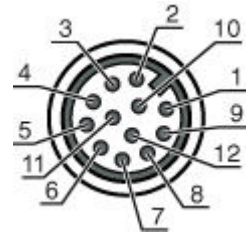

Connection 2	HOST
Type of connection	Connector
Function	Configuration interface Data interface
Thread size	M12
Type	Female
Material	Metal
No. of pins	4 -pin
Encoding	D-coded

Pin	Pin assignment
1	TD+
2	RD+
3	TD-
4	RD-

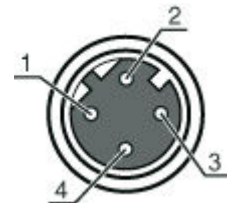

Diagrams

Reading distances

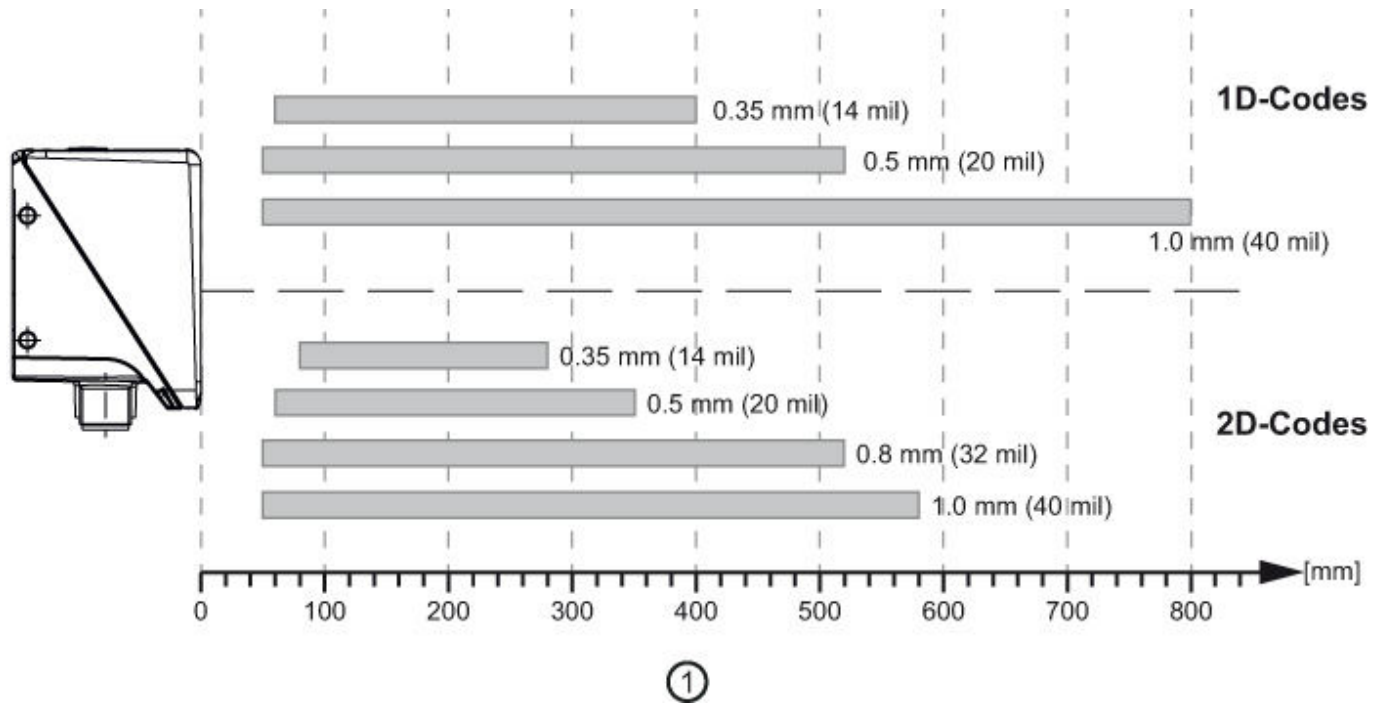

Relationship between camera distance and reading field size

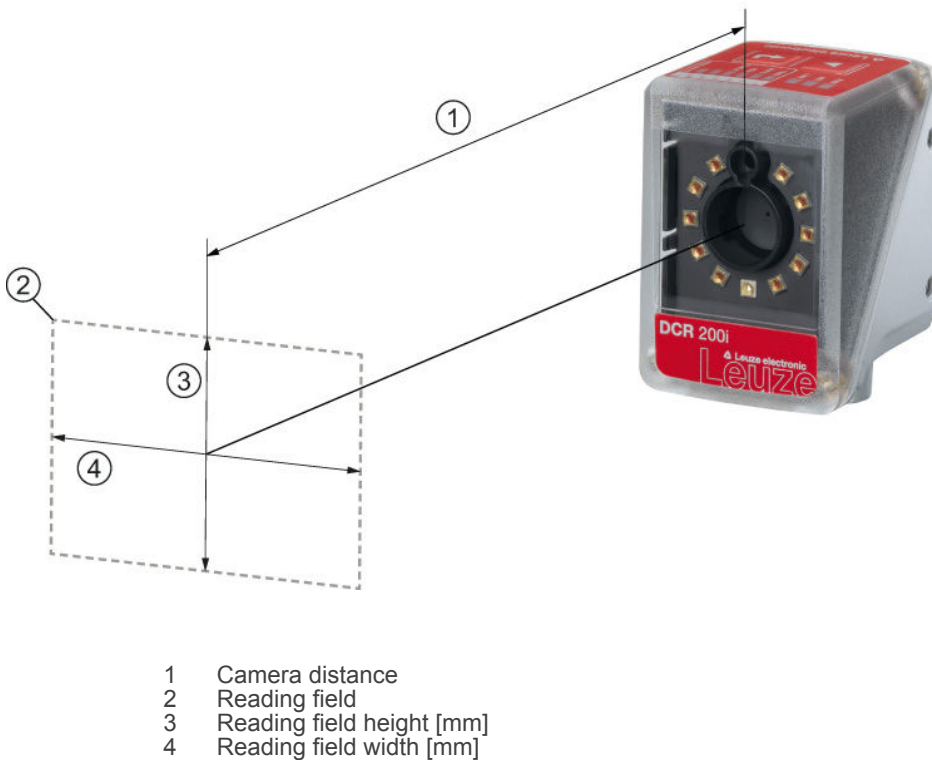

- 1 Camera distance
- 2 Reading field
- 3 Reading field height [mm]
- 4 Reading field width [mm]

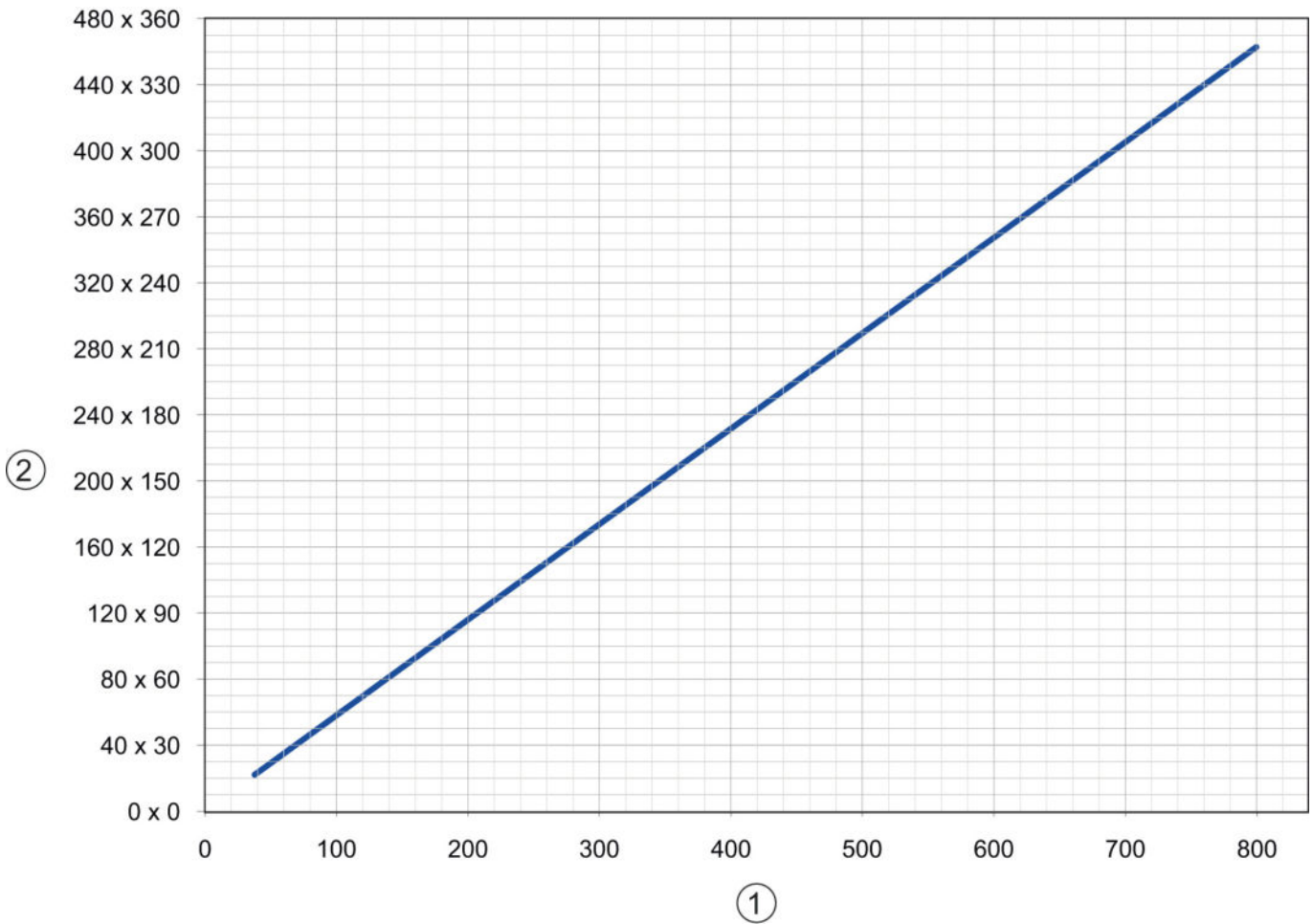

- 1 Camera distance [mm]
- 2 Reading field: width x height [mm]

Operation and display

LEDs

LED	Display	Meaning	
1	PWR	Off	No supply voltage
		Green, flashing	Initialization
		Green, continuous light	Operational readiness
		Orange, continuous light	Service operation
		Red, flashing	Device OK, warning set
		Red, continuous light	Device error
2	NET	Off	No supply voltage
		Green, flashing	Initialization
		Green, continuous light	Operational readiness
		Red, flashing	Communication error
		Red, continuous light	Network error
3	LINK	Green, continuous light	Ethernet connection is established
		Yellow, flashing	Data exchange active
4	TRIG	Green, flashing	Trigger and display of the read quality
5	AUTO	Green, flashing	Auto-setup and display of the read quality

Part no.: 50137573 – DCR 248i FIX-L1-102-R3-G – Stationary 2D-code reader

LED	Display	Meaning
6	ADJ	Green, flashing
7	TEACH	Green, flashing

Part number code

Part designation: DCR XXX YYY-Z-AAA-BC-D-EEEE

DCR	Operating principle: DCR: Dual Code Reader
XXXX	Series/interface (integrated fieldbus technology): 202i: Ethernet TCP/IP, UDP, RS 232/RS 422 248i: PROFINET-IO, Ethernet TCP/IP, UDP, RS 232/RS 422
YYY	Equipment: FIX: Fixed focal length
Z	Optics: U: Ultra high density (very close) N: High Density (close) M: Medium Density (medium distance) F: Low Density (remote) L: Ultra low density (very large distance)
AAA	Beam exit: 102: front
B	Illumination: R: Red light
C	Resolution range: 3: 1280 x 960 pixels
D	Protective screen: n/a: Plastic G: Glass P: Polarization filter
EEEE	Special equipment: V: Stainless steel housing F001: NPN inputs/outputs H: with heating

Note

A list with all available device types can be found on the Leuze electronic website at www.leuze.com.









Notes

Observe intended use!

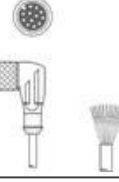
- This product is not a safety sensor and is not intended as personnel protection.
- The product may only be put into operation by competent persons.
- Only use the product in accordance with its intended use.

Accessories

Connection technology - Connection cables

	Part no.	Designation	Article	Description
	50130281	KD S-M12-CA-P1-020	Connection cable	Connection 1: Connector, M12, Axial, Female, A-coded, 12 -pin Connection 2: Open end Shielded: Yes Cable length: 2,000 mm Sheathing material: PUR
	50130282	KD S-M12-CA-P1-050	Connection cable	Connection 1: Connector, M12, Axial, Female, A-coded, 12 -pin Connection 2: Open end Shielded: Yes Cable length: 5,000 mm Sheathing material: PUR
	50130283	KD S-M12-CA-P1-100	Connection cable	Connection 1: Connector, M12, Axial, Female, A-coded, 12 -pin Connection 2: Open end Shielded: Yes Cable length: 10,000 mm Sheathing material: PUR
	50134943	KD S-M12-CW-P1-050	Connection cable	Connection 1: Connector, M12, Angled, Female, A-coded, 12 -pin Connection 2: Open end Shielded: Yes Cable length: 5,000 mm Sheathing material: PUR
	50135073	KS ET-M12-4A-P7-020	Connection cable	Suitable for interface: Ethernet Connection 1: Connector, M12, Axial, Male, D-coded, 4 -pin Connection 2: Open end Shielded: Yes Cable length: 2,000 mm Sheathing material: PUR
	50135074	KS ET-M12-4A-P7-050	Connection cable	Suitable for interface: Ethernet Connection 1: Connector, M12, Axial, Male, D-coded, 4 -pin Connection 2: Open end Shielded: Yes Cable length: 5,000 mm Sheathing material: PUR
	50135075	KS ET-M12-4A-P7-100	Connection cable	Suitable for interface: Ethernet Connection 1: Connector, M12, Axial, Male, D-coded, 4 -pin Connection 2: Open end Shielded: Yes Cable length: 10,000 mm Sheathing material: PUR
	50135076	KS ET-M12-4A-P7-150	Connection cable	Suitable for interface: Ethernet Connection 1: Connector, M12, Axial, Male, D-coded, 4 -pin Connection 2: Open end Shielded: Yes Cable length: 15,000 mm Sheathing material: PUR
	50135077	KS ET-M12-4A-P7-300	Connection cable	Suitable for interface: Ethernet Connection 1: Connector, M12, Axial, Male, D-coded, 4 -pin Connection 2: Open end Shielded: Yes Cable length: 30,000 mm Sheathing material: PUR

Part no.: 50137573 – DCR 248i FIX-L1-102-R3-G – Stationary 2D-code reader

	Part no.	Designation	Article	Description
	50134942	KS ET-M12-4W-P7-050	Connection cable	Suitable for interface: Ethernet Connection 1: Connector, M12, Angled, Male, D-coded, 4 -pin Connection 2: Open end Shielded: Yes Cable length: 5,000 mm Sheathing material: PUR

Connection technology - Interconnection cables

	Part no.	Designation	Article	Description
	50132488	KB JST-M12A-12P-50	Interconnection cable	
	50137694	KDS S-M12-CA-M12-5A-P1-004-23X	Interconnection cable	Connection 1: Connector, M12, Axial, Female, A-coded, 12 -pin Connection 2: Connector, M12, Axial, Male, A-coded, 5 -pin Shielded: Yes Cable, crossed: Connection 1, pin 2 <-> connection 2, pin 3 Cable length: 400 mm Sheathing material: PUR
	50130284	KDS S-M12-CA-M12-CA-P1-020	Interconnection cable	Connection 1: Connector, M12, Axial, Female, A-coded, 12 -pin Connection 2: Connector, M12, Axial, Male, A-coded, 12 -pin Shielded: Yes Cable length: 2,000 mm Sheathing material: PUR
	50130285	KDS S-M12-CA-M12-CA-P1-050	Interconnection cable	Connection 1: Connector, M12, Axial, Female, A-coded, 12 -pin Connection 2: Connector, M12, Axial, Male, A-coded, 12 -pin Shielded: Yes Cable length: 5,000 mm Sheathing material: PUR
	50130286	KDS S-M12-CA-M12-CA-P1-100	Interconnection cable	Connection 1: Connector, M12, Axial, Female, A-coded, 12 -pin Connection 2: Connector, M12, Axial, Male, A-coded, 12 -pin Shielded: Yes Cable length: 10,000 mm Sheathing material: PUR
	50137077	KSS ET-M12-4A-M12-4A-P7-020	Interconnection cable	Suitable for interface: Ethernet Connection 1: Connector, M12, Axial, Male, D-coded, 4 -pin Connection 2: Connector, M12, Axial, Male, D-coded, 4 -pin Shielded: Yes Cable length: 1,000 mm Sheathing material: PUR
	50137078	KSS ET-M12-4A-M12-4A-P7-050	Interconnection cable	Suitable for interface: Ethernet Connection 1: Connector, M12, Axial, Male, D-coded, 4 -pin Connection 2: Connector, M12, Axial, Male, D-coded, 4 -pin Shielded: Yes Cable length: 1,000 mm Sheathing material: PUR
	50137079	KSS ET-M12-4A-M12-4A-P7-100	Interconnection cable	Suitable for interface: Ethernet Connection 1: Connector, M12, Axial, Male, D-coded, 4 -pin Connection 2: Connector, M12, Axial, Male, D-coded, 4 -pin Shielded: Yes Cable length: 10,000 mm Sheathing material: PUR

Part no.: 50137573 – DCR 248i FIX-L1-102-R3-G – Stationary 2D-code reader

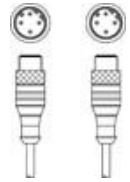
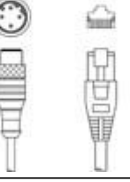
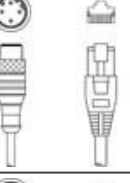
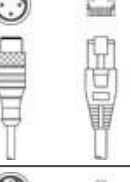
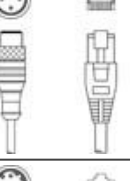
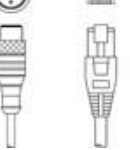
	Part no.	Designation	Article	Description
	50137080	KSS ET-M12-4A-M12-4A-P7-150	Interconnection cable	Suitable for interface: Ethernet Connection 1: Connector, M12, Axial, Male, D-coded, 4 -pin Connection 2: Connector, M12, Axial, Male, D-coded, 4 -pin Shielded: Yes Cable length: 15,000 mm Sheathing material: PUR
	50135080	KSS ET-M12-4A-RJ45-A-P7-020	Interconnection cable	Suitable for interface: Ethernet Connection 1: Connector, M12, Axial, Male, D-coded, 4 -pin Connection 2: RJ45 Shielded: Yes Cable length: 2,000 mm Sheathing material: PUR
	50135081	KSS ET-M12-4A-RJ45-A-P7-050	Interconnection cable	Suitable for interface: Ethernet Connection 1: Connector, M12, Axial, Male, D-coded, 4 -pin Connection 2: RJ45 Shielded: Yes Cable length: 5,000 mm Sheathing material: PUR
	50135082	KSS ET-M12-4A-RJ45-A-P7-100	Interconnection cable	Suitable for interface: Ethernet Connection 1: Connector, M12, Axial, Male, D-coded, 4 -pin Connection 2: RJ45 Shielded: Yes Cable length: 10,000 mm Sheathing material: PUR
	50135083	KSS ET-M12-4A-RJ45-A-P7-150	Interconnection cable	Suitable for interface: Ethernet Connection 1: Connector, M12, Axial, Male, D-coded, 4 -pin Connection 2: RJ45 Shielded: Yes Cable length: 15,000 mm Sheathing material: PUR
	50135084	KSS ET-M12-4A-RJ45-A-P7-300	Interconnection cable	Suitable for interface: Ethernet Connection 1: Connector, M12, Axial, Male, D-coded, 4 -pin Connection 2: RJ45 Shielded: Yes Cable length: 30,000 mm Sheathing material: PUR

Mounting technology - Mounting brackets

	Part no.	Designation	Article	Description
	50132151	BT 320M	Mounting bracket	Design of mounting device: Angle, L-shape Fastening, at system: Through-hole mounting Mounting bracket, at device: Screw type Type of mounting device: Rigid Material: Metal





Mounting technology - Rod mounts

	Part no.	Designation	Article	Description
	50132150	BTU 320M-D12	Mounting system	Contains: 4x M4 x 6 screws Design of mounting device: Mounting system Fastening, at system: For 12 mm rod Mounting bracket, at device: Screw type Type of mounting device: Clampable, Adjustable, Turning, 360° Material: Metal



Part no.: 50137573 – DCR 248i FIX-L1-102-R3-G – Stationary 2D-code reader

	Part no.	Designation	Article	Description
	50132453	BTU 320M-D12-RL70	Mounting system	Contains: 4x M4 x 6 screws Design of mounting device: Mounting system Fastening, at system: For 12 mm rod Mounting bracket, at device: Screw type Type of mounting device: Turning, 360°, Adjustable, Clampable Material: Metal

General

	Part no.	Designation	Article	Description
	50132562	AC-RL-70/40-Diff	Vision component	
	50131462	Cover DCR 200i	Cover hood	Housing material: Plastic Optics cover: Plastic
	50131461	Cover DCR 200i-G	Cover hood	Housing material: Plastic Optics cover: Glass
	50131460	Cover DCR 200i-P	Cover hood	Housing material: Plastic Optics cover: Glass with polarization filter
	50131459	Diffusor DCR 200i	Film	
	50132511	RL-70/40r-003-M12	Illumination	

Services

	Part no.	Designation	Article	Description
	S981014	CS30-S-110	Start-up support	Details: Performed at location of customer's choosing, duration: max. 10 hours. Conditions: Devices and connection cables are already mounted, price not including travel costs and, if applicable, accommodation expenses. Restrictions: No mechanical (mounting) and electrical (wiring) work performed, no changes (attachments, wiring, programming) to third-party components in the nearby environment.
	S981019	CS30-T-110	Product training	Details: Location and content to be agreed upon, duration: max. 10 hours. Conditions: Price not including travel costs and, if applicable, accommodation expenses. Restrictions: Travel costs and accommodation expenses charged separately and according to expenditure.