



Figure can vary

**Part no.: 50136261**  
**PRK3C.A3/2N-M8**  
**Polarized retro-reflective photoelectric sensor**



## Contents

- Technical data
- Dimensioned drawings
- Electrical connection
- Diagrams
- Operation and display
- Reflectors & reflective tapes
- Part number code
- Notes
- Accessories

## Technical data

<b>Basic data</b>	
Series	3C
Operating principle	Reflection principle
<b>Special design</b>	
Special design	Autocollimation
<b>Optical data</b>	
Operating range	Guaranteed operating range
Operating range	0 ... 4 m , With reflector TK(S) 100x100
Operating range limit	Typical operating range
Operating range limit	0 ... 5 m , With reflector TK(S) 100x100
Light source	LED , Red
LED light wavelength	635 nm
LED group	Exempt group (in acc. with EN 62471)
Transmitted-signal shape	Pulsed
<b>Electrical data</b>	
Protective circuit	Polarity reversal protection Short circuit protected
<b>Performance data</b>	
Supply voltage $U_B$	10 ... 30 V , DC , Incl. residual ripple
Residual ripple	0 ... 15 % , From $U_B$
Open-circuit current	0 ... 15 mA
<b>Outputs</b>	
Number of digital switching outputs	2 Piece(s)
<b>Switching outputs</b>	
Voltage type	DC
Switching current, max.	100 mA
Switching voltage	High: $\geq(U_B-2V)$ Low: $\leq 2V$
<b>Switching output 1</b>	
Assignment	Connection 1, pin 4
Switching element	Transistor , NPN
Switching principle	Light switching
<b>Switching output 2</b>	
Assignment	Connection 1, pin 2
Switching element	Transistor , NPN
Switching principle	Dark switching
<b>Timing</b>	
Switching frequency	1,500 Hz
Response time	0.33 ms
Readiness delay	300 ms
Response jitter	110 $\mu$ s
<b>Connection</b>	

**Connection 1**

Type of connection	Connector
Function	Signal OUT Voltage supply
Thread size	M8
Type	Male
Material	Metal
No. of pins	4 -pin

**Mechanical data**

Dimension (W x H x L)	11.4 mm x 34.2 mm x 18.3 mm
Housing material	Plastic , PC-ABS
Lens cover material	Plastic / PMMA
Net weight	10 g
Housing color	Red
Type of fastening	Through-hole mounting Via optional mounting device
Compatibility of materials	ECOLAB

**Operation and display**

Type of display	LED
Number of LEDs	2 Piece(s)
Operational controls	Teach button
Function of the operational control	Sensitivity adjustment

**Environmental data**

Ambient temperature, operation	-40 ... 60 °C
Ambient temperature, storage	-40 ... 70 °C

**Certifications**

Degree of protection	IP 67 IP 69K
Protection class	III
Certifications	c UL US
Standards applied	IEC 60947-5-2

**Classification**

Customs tariff number	85365019
eCl@ss 8.0	27270902
eCl@ss 9.0	27270902
ETIM 5.0	EC002717
ETIM 6.0	EC002717

## Dimensioned drawings

All dimensions in millimeters

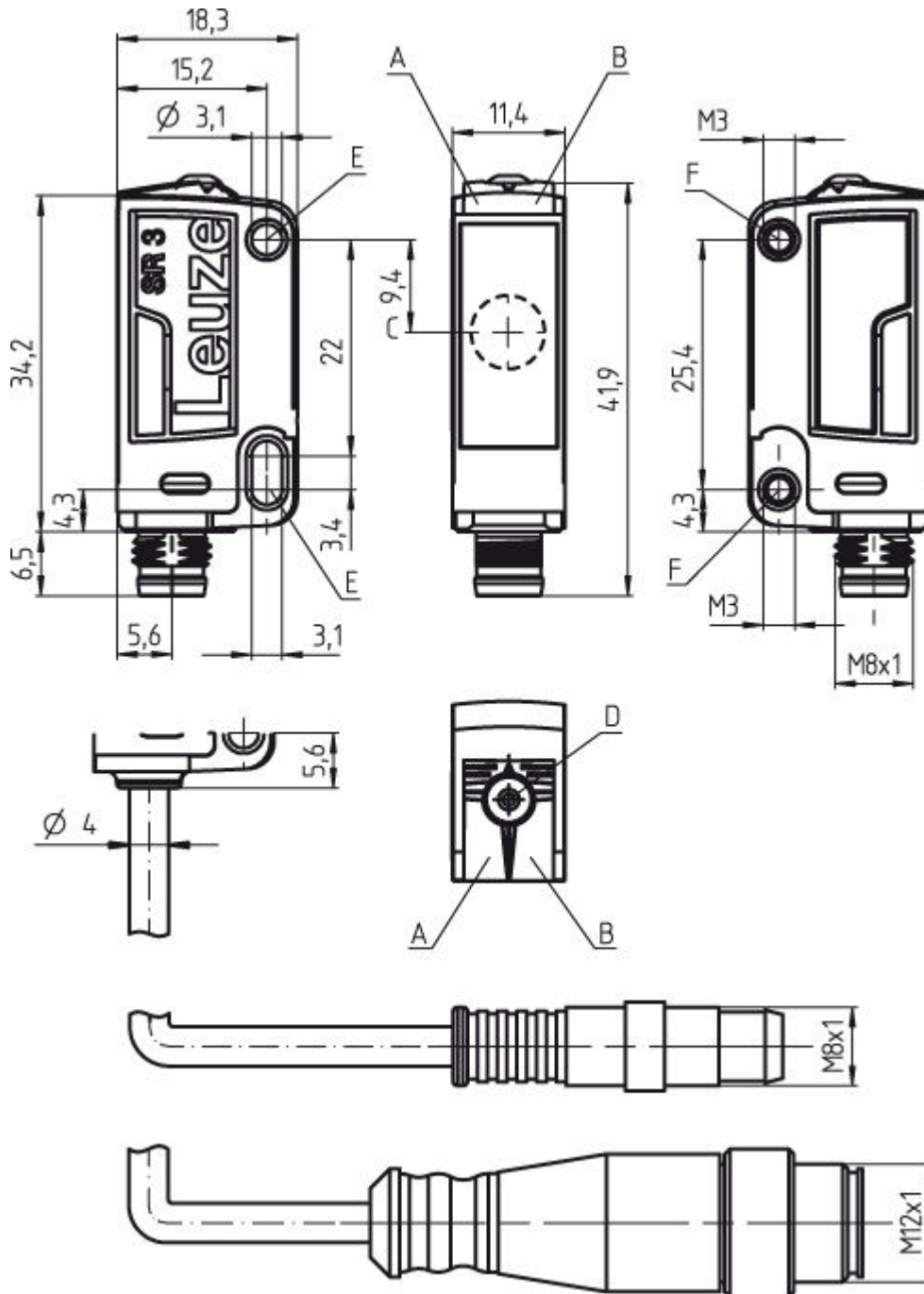

- A Green LED
- B Yellow LED
- C Optical axis
- D Teach button
- E Mounting sleeve (standard)
- F Threaded sleeve (3C.B series)

## Electrical connection

Connection 1	
Type of connection	Connector
Function	Signal OUT Voltage supply

Part no.: 50136261 – PRK3C.A3/2N-M8 – Polarized retro-reflective photoelectric

Connection 1	
Thread size	M8
Type	Male
Material	Metal
No. of pins	4 -pin
Encoding	

Pin	Pin assignment
1	V+
2	OUT 2
3	GND
4	OUT 1

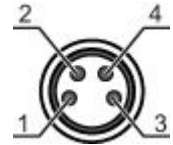

## Diagrams

Typ. response behavior

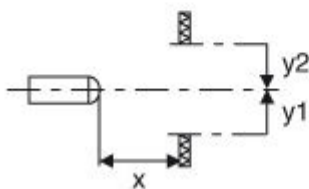
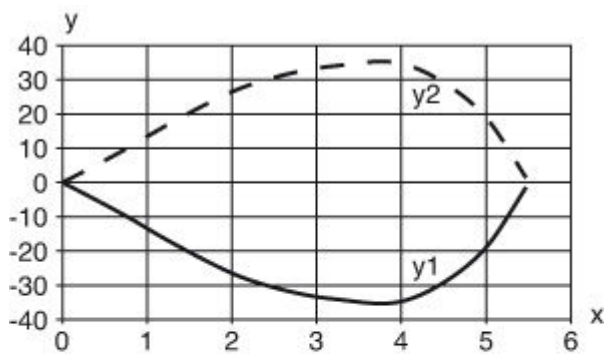

x Distance [m]  
y Misalignment [mm]

### Typ. function reserve

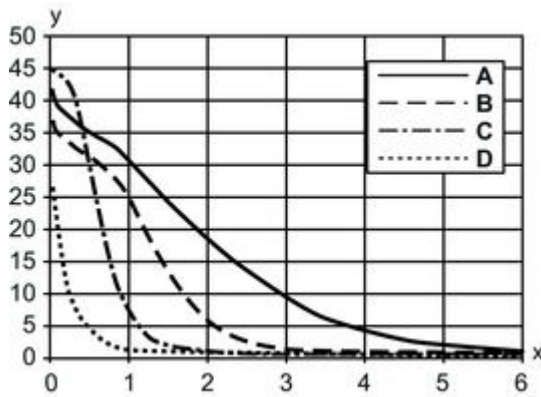



x Distance [m]  
 y Function reserve  
 A TKS 100x100  
 B TKS 40x60  
 C TKS 20x40  
 D Film REF 4-A-50x50

### Operation and display



#### LEDs

LED	Display	Meaning
1	Green, continuous light	Ready
2	Yellow, continuous light	Light path free
	Yellow, flashing	Light path free, no function reserve

### Reflectors & reflective tapes

	Part no.	Designation	Operating range/ Operating range limit	Description
	50108300	REF 4-A-50x50	0 ... 0.7 m 0 ... 1 m	Design: Rectangular Reflective surface: 50 mm x 50 mm Material: Plastic Chemical designation of the material: PMMA Fastening: Self-adhesive
	50003192	TK 100x100	0 ... 4 m 0 ... 5 m	Design: Rectangular Reflective surface: 96 mm x 96 mm Triple reflector size: 4 mm Material: Plastic Base material: Plastic Chemical designation of the material: PMMA8N Fastening: Adhesive

**Part no.: 50136261 – PRK3C.A3/2N-M8 – Polarized retro-reflective photoelectric**

	Part no.	Designation	Operating range/ Operating range limit	Description
	50022816	TKS 100X100	0 ... 4 m 0 ... 5 m	Design: Rectangular Reflective surface: 96 mm x 96 mm Triple reflector size: 4 mm Material: Plastic Base material: Plastic Chemical designation of the material: PMMA8N Fastening: Through-hole mounting, Adhesive
	50081283	TKS 20X40	0 ... 1.3 m 0 ... 1.5 m	Design: Rectangular Reflective surface: 16 mm x 38 mm Triple reflector size: 2.3 mm Material: Plastic Base material: Plastic Chemical designation of the material: PMMA8N Fastening: Through-hole mounting, Adhesive
	50040820	TKS 40X60	0 ... 2.6 m 0 ... 3.2 m	Design: Rectangular Reflective surface: 37 mm x 56 mm Triple reflector size: 4 mm Material: Plastic Base material: Plastic Chemical designation of the material: PMMA8N Fastening: Through-hole mounting, Adhesive

## Part number code

Part designation: **AAA 3C d EE-f.GG H/i J-K**

AAA3C	<b>Operating principle / construction:</b> HT3C: diffuse reflection sensor with background suppression LS3C: throughbeam photoelectric sensor transmitter LE3C: throughbeam photoelectric sensor receiver PRK3C: retro-reflective photoelectric sensor with polarization filter
d	<b>Light type:</b> n/a: red light l: infrared light
EE	<b>Light source:</b> n/a: LED L1: laser class 1 L2: laser class 2
f	<b>Pre-set range (optional):</b> n/a: operating range acc. to data sheet XXXX: pre-set range [mm]
GG	<b>Equipment:</b> n/a: standard A: autocollimation principle (single lens) for positioning tasks B: housing model with two M3 threaded sleeves, brass F: permanently set range L: long light spot S: small light spot T: autocollimation principle (single lens) for highly transparent bottles without tracking TT: autocollimation principle (single lens) for highly transparent bottles with tracking V: V-optics XL: extra long light spot
H	<b>Operating range adjustment:</b> n/a with HT: range adjustable via 8-turn potentiometer n/a with retro-reflective photoelectric sensors (PRK): operating range not adjustable 1: 270° potentiometer 3: teach-in via button 6: auto-teach

**Part no.: 50136261 – PRK3C.A3/2N-M8 – Polarized retro-reflective photoelectric**

i	<b>Switching output/function OUT 1/IN: Pin 4 or black conductor:</b> 2: NPN transistor output, light switching N: NPN transistor output, dark switching 4: PNP transistor output, light switching P: PNP transistor output, dark switching 6: push-pull switching output, PNP light switching, NPN dark switching G: push-pull switching output, PNP dark switching, NPN light switching /L: IO-Link 8: activation input (activation with high signal) X: pin not used
J	<b>Switching output / function OUT 2/IN: pin 2 or white conductor:</b> 2: NPN transistor output, light switching N: NPN transistor output, dark switching 4: PNP transistor output, light switching P: PNP transistor output, dark switching 6: push-pull switching output, PNP light switching, NPN dark switching G: push-pull switching output, PNP dark switching, NPN light switching W: warning output X: pin not used 8: activation input (activation with high signal) 9: deactivation input (deactivation with high signal) T: teach-in via cable
K	<b>Electrical connection:</b> n/a: cable, standard length 2000 mm, 4-wire 5000: cable, standard length 5000 mm, 4-wire M8: M8 connector, 4-pin (plug) M8.3: M8 connector, 3-pin (plug) 200-M8: cable, length 200 mm with M8 connector, 4-pin, axial (plug) 200-M8.3: cable, length 200 mm with M8 connector, 3-pin, axial (plug) 200-M12: cable, length 200 mm with M12 connector, 4-pin, axial (plug)

**Note**

A list with all available device types can be found on the Leuze electronic website at [www.leuze.com](http://www.leuze.com).

**Notes**
**Observe intended use!**

- This product is not a safety sensor and is not intended as personnel protection.
- The product may only be put into operation by competent persons.
- Only use the product in accordance with its intended use.

**For UL applications:**



- For UL applications, use is only permitted in Class 2 circuits in accordance with the NEC (National Electric Code).
- These proximity switches shall be used with UL Listed Cable assemblies rated 30V, 0.5A min, in the field installation, or equivalent (categories: CYJV/CYJV7 or PVVA/PVVA7)

- Light source: Average life expectancy 100,000 h at an ambient temperature of 25 °C
- Response time: For short decay times, an ohmic load of approx. 5 kOhm is recommended
- Sum of the output currents for both outputs, 50 mA for ambient temperatures > 40 °C

Part no.: 50136261 – PRK3C.A3/2N-M8 – Polarized retro-reflective photoelectric

## Accessories

### Connection technology - Connection cables

	Part no.	Designation	Article	Description
	50130850	KD U-M8-4A-V1-050	Connection cable	Connection 1: Connector, M8, Axial, Female, 4 -pin Connection 2: Open end Shielded: No Cable length: 5,000 mm Sheathing material: PVC
	50130871	KD U-M8-4W-V1-050	Connection cable	Connection 1: Connector, M8, Angled, Female, 4 -pin Connection 2: Open end Shielded: No Cable length: 5,000 mm Sheathing material: PVC



### Mounting technology - Mounting brackets

	Part no.	Designation	Article	Description
	50060511	BT 3	Mounting device	Design of mounting device: Angle, L-shape Fastening, at system: Through-hole mounting Mounting bracket, at device: Screw type Type of mounting device: Rigid Material: Metal

### Mounting technology - Rod mounts

	Part no.	Designation	Article	Description
	50117255	BTU 200M-D12	Mounting system	Contains: 2x M3 x 16 screw, 2x M3 x 20 screw, 2x position washers Design of mounting device: Mounting system Fastening, at system: For 12 mm rod, Sheet-metal mounting Mounting bracket, at device: Screw type Type of mounting device: Clampable, Adjustable, Turning, 360° Material: Metal

## Standard reflectors

	Part no.	Designation	Article	Description
	50081283	TKS 20X40	Reflector	Design: Rectangular Reflective surface: 16 mm x 38 mm Triple reflector size: 2.3 mm Material: Plastic Base material: Plastic Chemical designation of the material: PMMA8N Fastening: Through-hole mounting, Adhesive
	50040820	TKS 40X60	Reflector	Design: Rectangular Reflective surface: 37 mm x 56 mm Triple reflector size: 4 mm Material: Plastic Base material: Plastic Chemical designation of the material: PMMA8N Fastening: Through-hole mounting, Adhesive

Part no.: 50136261 – PRK3C.A3/2N-M8 – Polarized retro-reflective photoelectric  
Reflective tapes for standard applications

	Part no.	Designation	Article	Description
	50108300	REF 4-A-50x50	Reflective tape	Design: Rectangular Reflective surface: 50 mm x 50 mm Material: Plastic Chemical designation of the material: PMMA Fastening: Self-adhesive