

**DMU318...W 90° angled ultrasonic sensors with analog and switching output**

en 01-2017/02 50135824

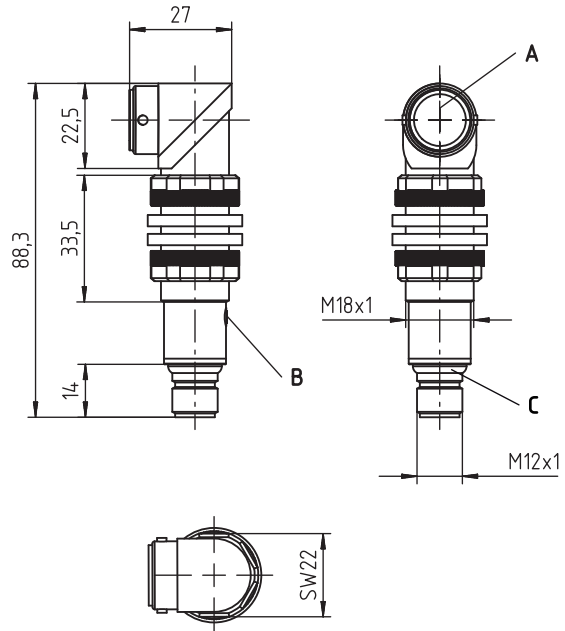

**Dimensioned drawing**



- A Active sensor surface
- B Teach-in button
- C Indicator diodes

**Electrical connection**

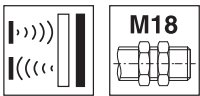
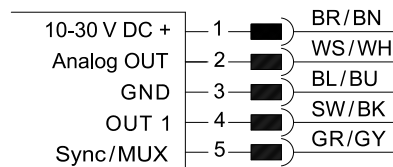

**50 ... 400mm**  
**150 ... 1600mm**

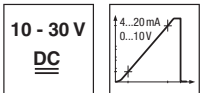

- Function largely independent of surface properties, ideal for detection of liquids, bulk materials, transparent media, ...
- Sound exit less than 90° to the longitudinal axis
- Small dead zone at long scanning range
- 1 analog output 0 ... 10V or 4 ... 20mA
- 1 switching output (PNP or NPN)
- NO/NC function reversible
- **NEW** – Both outputs can easily be taught using a button
- **NEW** – Stable plastic design
- **NEW** – Temperature-compensated scanning range

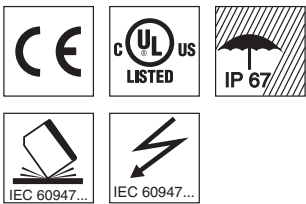

**Accessories:**

(available separately)

- Mounting systems
- Mounting adapter M18-M30: BTX-D18M-D30 (Part no. 50125860)
- Cables with M12 connector (KD ...)

We reserve the right to make changes • PAL\_DMU318\_400W\_1600W\_en\_50135824.fm

**Technical data**

**Ultrasonic specifications**

Scanning range <sup>1)</sup>  
 Adjustment range  
 Ultrasonic frequency  
 Typ. opening angle  
 Resolution  
 Direction of beam  
 Reproducibility  
 Switching hysteresis  
 Analog output accuracy  
 Temperature drift

**DMU318-400.W3/...-M12**

50 ... 400mm <sup>2)</sup>  
 50 ... 400mm  
 300kHz  
 8°  
 < 2mm  
 90° to longitudinal axis  
 ± 0.5% <sup>1) 3)</sup>  
 1% <sup>3)</sup>  
 1% <sup>3)</sup>  
 ≤ 5% <sup>4)</sup>

**DMU318-1600.W3/...-M12**

150 ... 1600mm <sup>2)</sup>  
 150 ... 1600mm  
 230kHz  
 8°  
 < 2mm  
 90° to longitudinal axis  
 ± 0.5% <sup>1) 3)</sup>  
 1% <sup>3)</sup>  
 1% <sup>3)</sup>  
 ≤ 5% <sup>4)</sup>

**Timing**

Switching frequency  
 Response time  
 Readiness delay

10Hz  
 500ms  
 < 900ms (analog output),  
 < 500ms (switching output)

2Hz  
 500ms  
 < 900ms (analog output),  
 < 500ms (switching output)

**Electrical data**

Operating voltage  $U_B$  <sup>5)</sup>  
 Residual ripple  
 Open-circuit current

10 ... 30V DC (incl. ± 7% residual ripple)  
 ± 7% of  $U_B$   
 ≤ 50mA

**Analog output**

Analog output

.../...C... 1 analog output 4 ... 20mA  
 .../...V... 1 analog output 0 ... 10V

Load resistance

Current output:  $R_L \leq 500\Omega$ ,  
 Voltage output:  $R_L \geq 2k\Omega$

Characteristic curve adjustment

1-point teach: teach in button 2 ... 7s,  
 2-point teach: teach in button 7 ... 12s,  
 Characteristic curve inversion: teach in button > 12s  
 Distance too small: approx. 3.8mA,  
 Distance too large: approx. 11V / approx. 21mA

Analog output error signal

**Switching output**

Switching output / Function

.../4... 1 PNP transistor switching output  
 OUT 1 (pin 4): NO contact preset  
 .../2... 1 NPN transistor switching output  
 OUT 1 (pin 4): NO contact preset

Output current

Max. 100mA  
 1-point teach: teach-in button 2 ... 7s,  
 2-point teach: teach-in button 7 ... 12s  
 Teach-in button > 12s

Switching range adjustment

Changeover NO/NC

**Indicators**

Yellow LED  
 Blue LED  
 Yellow/green or blue/green LED flashing  
 Green LED

OUT2: object detected  
 Analog OUT: object detected  
 Teach-in / teaching error  
 Object within the scanning range

**Mechanical data**

Housing  
 Active surface  
 Weight  
 Ultrasonic transducer  
 Connection type  
 Fitting position

Plastic (PBT)  
 Epoxy resin, glass fiber reinforced  
 75g  
 Piezoceramic <sup>6)</sup>  
 M12 connector, 5-pin  
 Any

**Environmental data**

Ambient temp. (operation/storage)  
 Protective circuit <sup>7)</sup>  
 VDE protection class  
 Degree of protection  
 Standards applied  
 Certifications

-20° ... +70°C/-20° ... +70°C  
 1, 2, 3  
 III  
 IP 67  
 EN 60947-5-2  
 UL 508, CSA C22.2 No.14-13 <sup>5) 8)</sup>

- 1) At 20°C
- 2) Target: 200mm x 200mm plate
- 3) From end value
- 4) Over the temperature range -20°C ... +70°C
- 5) For UL applications: use is permitted exclusively in Class 2 circuits according to NEC
- 6) The ceramic material of the ultrasonic transducer contains lead zirconium titanate (PZT)
- 7) 1=short-circuit and overload protection, 2=polarity reversal protection, 3=wire break and inductive protection
- 8) These proximity switches shall be used with UL Listed Cable assemblies rated 30V, 0.5A min, in the field installation, or equivalent (categories: CYJV/CYJV7 or PVVA/PVVA7)

**Diagrams**

**DMU318-400.W3/...-M12**

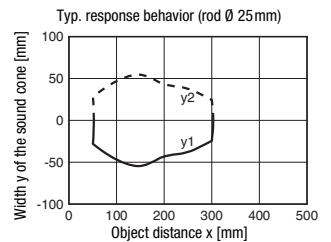
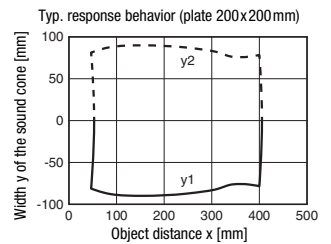

**DMU318-1600.W3/...-M12**

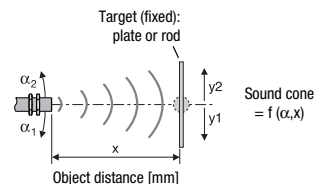
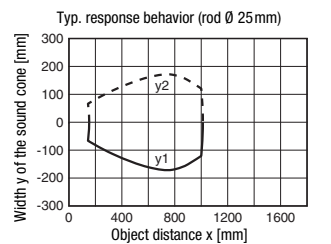
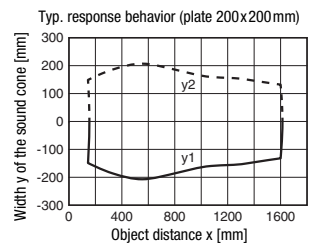

**Notes**

**Observe intended use!**

- ⚠ This product is not a safety sensor and is not intended as personnel protection.
- ⚠ The product may only be put into operation by competent persons.
- ⚠ Only use the product in accordance with its intended use.

# DMU318...W 90° angled ultrasonic sensors with analog and switching output

## Part number code

D M U 3 1 8 - 1 6 0 0 . W 3 / 4 V K - M 1 2

### Operating principle

**HTU** Ultrasonic sensor, scanning principle, with background suppression  
**DMU** Ultrasonic sensor, distance measurement  
**RKU** Ultrasonic sensor, retro-reflective ultrasonic sensor

### Series

**318** 318 series, cylindrical short M18 design

### Scanning range in mm

**400** 50 ... 400  
**1600** 150 ... 1600

### Equipment

**W** Design with 90° angled head  
**3** Teach button on the sensor

### Pin assignment of connector pin 4 / black cable wire (OUT1)

**4** PNP output, NO contact preset  
**P** PNP output, NC contact preset  
**2** NPN output, NO contact preset  
**N** NPN output, NC contact preset

### Pin assignment of connector pin 2 / white cable wire (Analog OUT/OUT2)

**4** PNP output, NO contact preset  
**P** PNP output, NC contact preset  
**2** NPN output, NO contact preset  
**N** NPN output, NC contact preset  
**C** Analog output 4 ... 20mA  
**V** Analog output 0 ... 10V

### Pin assignment of connector pin 5 / gray cable wire (Sync / MUX)

**K** Synchronization/multiplex input

### Connection technology

**M12** M12 connector, 5-pin

## Order guide

The sensors listed here are preferred types; current information at [www.leuze.com](http://www.leuze.com).

### Scanning range / switching output / analog output / teach-in / design

	Designation	Part no.
50 ... 400mm / PNP / current output 4 ... 20mA / teach button / with 90° angled head	DMU318-400.W3/4CK-M12	50136102
50 ... 400mm / PNP / voltage output 0 ... 10V / teach button / with 90° angled head	DMU318-400.W3/4VK-M12	50136100
50 ... 400mm / NPN / current output 4 ... 20mA / teach button / with 90° angled head	DMU318-400.W3/2CK-M12	50136103
50 ... 400mm / NPN / voltage output 0 ... 10V / teach button / with 90° angled head	DMU318-400.W3/2VK-M12	50136101
150 ... 1600mm / PNP / current output 4 ... 20mA / teach button / with 90° angled head	DMU318-1600.W3/4CK-M12	50136108
150 ... 1600mm / PNP / voltage output 0 ... 10V / teach button / with 90° angled head	DMU318-1600.W3/4VK-M12	50136106
150 ... 1600mm / NPN / current output 4 ... 20mA / teach button / with 90° angled head	DMU318-1600.W3/2CK-M12	50136109
150 ... 1600mm / NPN / voltage output 0 ... 10V / teach button / with 90° angled head	DMU318-1600.W3/2VK-M12	50136107

### Device functions and indicators – switching output

The sensor has a button for setting switching output **OUT1** and analog output **Analog OUT**. Use the **teach button** to perform the 1-point teach, the 2-point window-teach and to changeover the switching function (NO contact/NC contact). Device status and switching states for **OUT1** are indicated as follows by means of a **yellow LED**:

#### Switching output OUT1

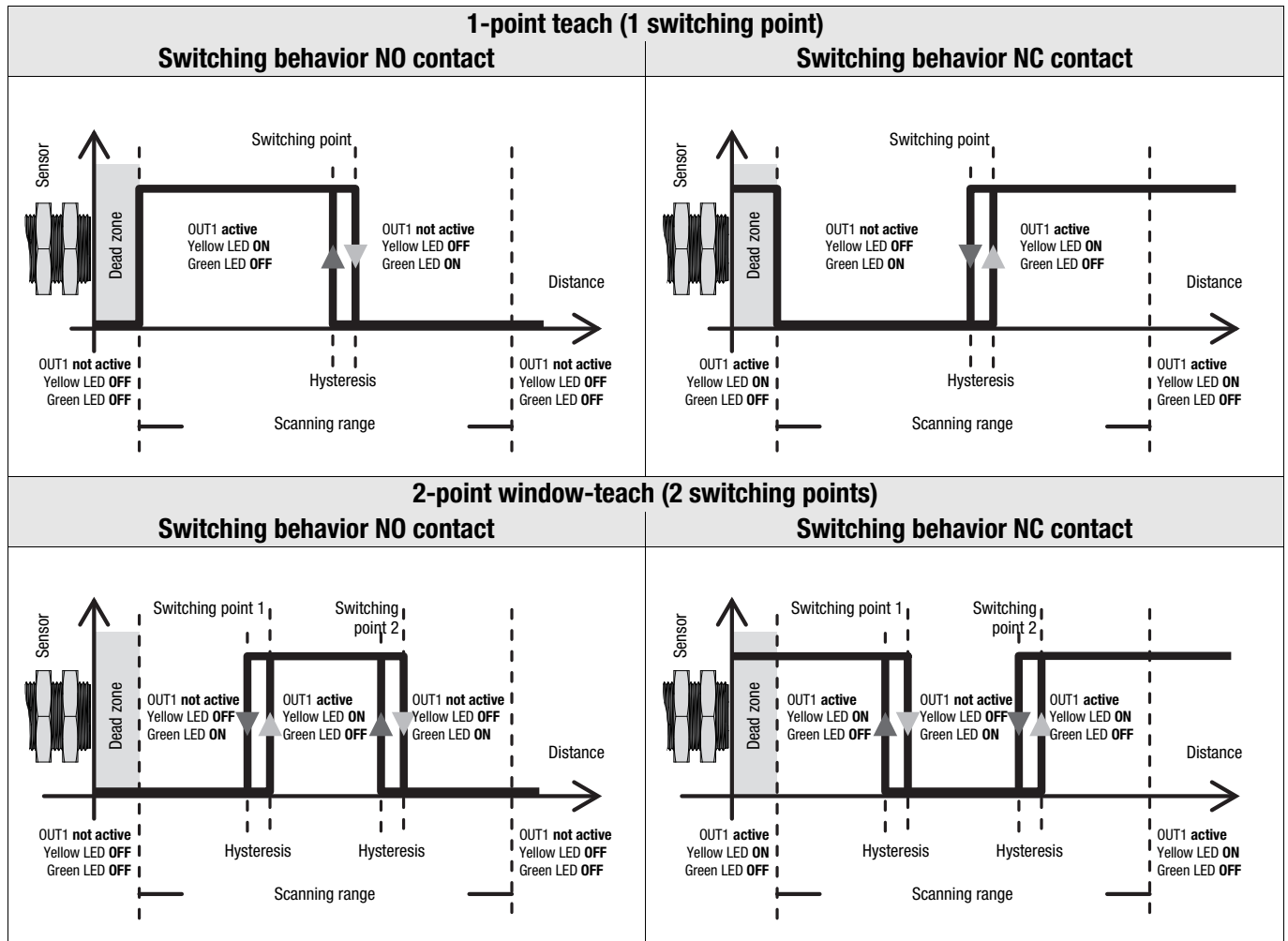

**Note!**  
The switching behavior is not defined in the dead zone.

#### Switching behavior with 2-point window-teach as a function of the switching function

Switching function configured as	First taught object distance	Second taught object distance	Output switching behavior
NO (normally open)	Close	Far	
	Far	Close	
NC (normally closed)	Close	Far	
	Far	Close	

## DMU318...W 90° angled ultrasonic sensors with analog and switching output

### Adjusting the switching points via the teach button

The switching point of the sensor is set to 400mm or 1600mm (static 1-point teach) on delivery.

By means of a simple operating procedure, the switching point for the output OUT1 can be individually taught to an arbitrary distance within the scanning range with 1-point teach (static) or 2-point window-teach (static).

Moreover, the output function can be switched from NO contact (NO - normally open) to NC contact (NC - normally closed).

#### Selecting the output that is to be taught: OUT1 or Analog OUT

1. Press the **teach button** for  $\geq 2$ s to **activate teach mode**. The **yellow LED (OUT 1) flashes** at 1 Hz.  
While in this state, **output OUT 1** can be taught.
2. To teach **output Analog OUT**, **briefly** press the **teach button** again. The **blue LED (Analog OUT)** now flashes at 1 Hz.  
While in this state, **output Analog OUT** can be taught.
3. Briefly press the teach button again to toggle between outputs **OUT 1** and **Analog OUT** in this state. The flashing LED indicates which output is ready for teaching:  
**yellow LED flashing = OUT 1 ready for teaching,**  
**blue LED flashing = Analog OUT ready for teaching.**

#### Teaching output OUT 1

First activate the previously described teach mode for output OUT 1.

1-point teach (static)	2-point window-teach (static) <sup>1)</sup>
<b>1. Place</b> object at desired switching distance.	<b>1. First, place</b> object at desired switching distance for <b>switching point 1</b> .
<b>2. To adjust</b> the output <b>OUT1</b> , <b>press</b> the <b>teach button</b> for 2 ... 7s until the <b>yellow LED flashes at 3Hz</b> .	<b>2. To adjust</b> the output <b>OUT1</b> , <b>press</b> the <b>teach button</b> for 7 ... 12s until the <b>yellow and green LEDs flash alternately at 3Hz</b> .
<b>3. Release</b> the <b>teach button</b> to complete the teach event. The current object distance has been taught as the new switching point.	<b>3. Release the button</b> . The sensor remains in teach mode and the LEDs continue to flash.
<b>4. Error-free teach:</b> LED states and switching behavior according to the diagram shown above. <b>Faulty teach</b> (object may be too close or too far away – please note scanning range): <b>green and yellow LEDs flash at 8Hz</b> until an error-free teach event is performed. The affected output is inactive as long as there is a teaching error.	<b>4. Then, place</b> the object at the desired switching distance for <b>switching point 2</b> . <b>Note:</b> The <b>minimum distance between the switching points</b> is as follows: scanning range of 400mm: <b>40mm</b> scanning range of 1600mm: <b>160mm</b>
	<b>5. Briefly press</b> the <b>teach button</b> again to complete the teach event. The switching window was taught in.
	<b>6. Error-free teach:</b> LED states and switching behavior according to the diagram shown above. <b>Faulty teach</b> (object may be too close or too far away – please note scanning range): <b>green and yellow LEDs flash at 8Hz</b> until an error-free teach event is performed.

1) See table "Switching behavior with 2-point window-teach as a function of the switching function"

## Adjusting the switching function (NC/NO) via the teach button

The switching function of the sensor is preset as follows on delivery:

- **OUT 1: NO contact**

The output function can be switched from NO contact (NO - normally open) to NC contact (NC - normally closed) and vice versa. If the switching function is changed, the switching output is changed to the opposite state (toggled).

**First activate the previously described teach mode for output OUT 1.**

<b>Changeover of the switching function</b>
<b>1.</b> To change the switching function of output <b>OUT 1</b> , <b>press the teach button for longer than 12s.</b> The current state of output <b>OUT 1</b> is frozen during the adjustment process.
<b>2.</b> The <b>green and yellow LEDs flash alternately at 3Hz.</b> If the <b>yellow LED</b> is <b>ON</b> afterwards, output <b>OUT 1</b> functions as a <b>normally open contact (NO)</b> . If the <b>yellow LED</b> is <b>OFF</b> afterwards, output <b>OUT 1</b> functions as a <b>normally closed contact (NC)</b> .

## DMU318...W 90° angled ultrasonic sensors with analog and switching output

### Device functions – analog output

In measurement operation, the **blue LED** displays the behavior of analog output **Analog OUT**.

#### Analog output Analog OUT

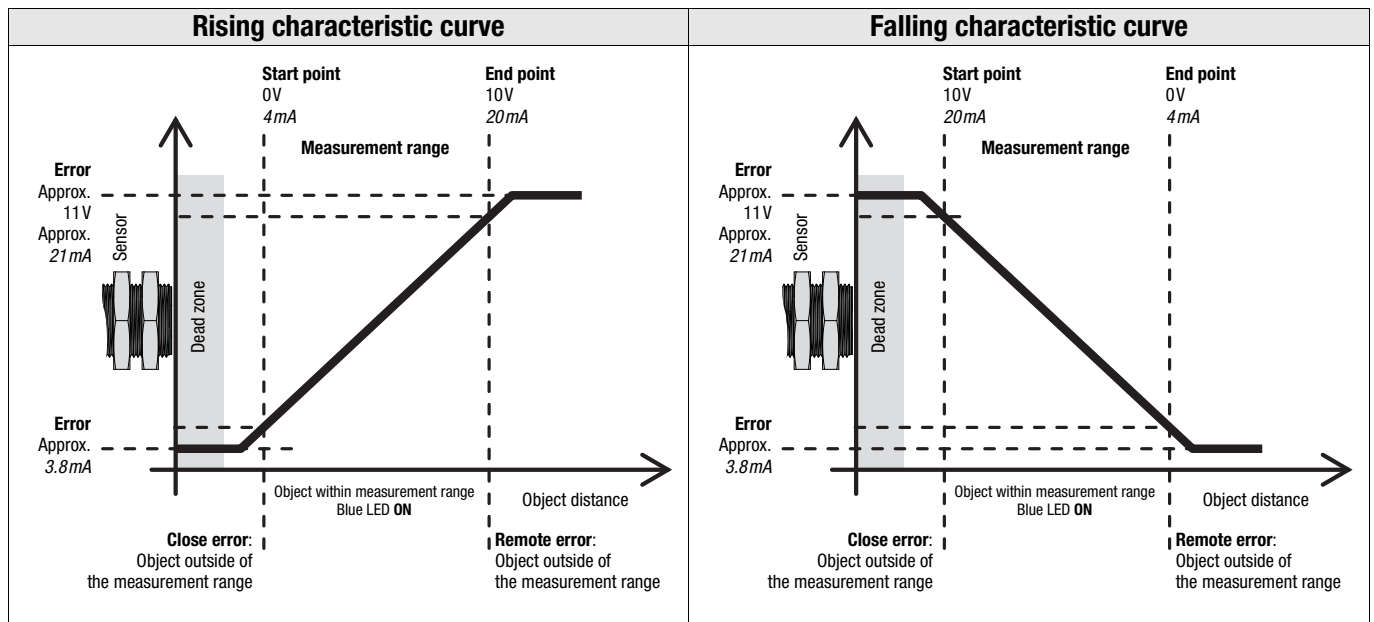

#### Note!

When setting the analog output (teach) via the teach button, one **rising characteristic curve** is always taught; with 2-point teach, independent of the selected object distances near/far. The characteristic output curve can be inverted, however.

### Adjusting the analog output via the teach button

On delivery, the characteristic output curve of the sensor is set as a rising characteristic curve with spread over the entire scanning range: 4 ... 20mA or 0 ... 10V corresponds to an object distance of 50 ... 400mm or 150 ... 1600mm, respectively.

The analog output can be set by means of 1-point teach or 2-point teach.



#### Note!

When setting the analog output (teach) via the teach input, one **rising characteristic curve** is always taught; with 2-point teach, independent of the selected object distances near/far. The characteristic output curve can be inverted, however.

#### Selecting the output that is to be taught: OUT1 or Analog OUT

1. Press the **teach button** for  $\geq 2s$  to **activate teach mode**. The **yellow LED (OUT 1)** flashes at 1Hz. While in this state, **output OUT 1** can be taught.
2. To teach **output Analog OUT**, **briefly** press the **teach button** again. The **blue LED (Analog OUT)** now flashes at 1Hz. While in this state, **output Analog OUT** can be taught.
3. Briefly press the teach button again to toggle between outputs **OUT 1** and **Analog OUT** in this state. The flashing LED indicates which output is ready for teaching:  
**yellow LED flashing = OUT 1 ready for teaching,**  
**blue LED flashing = Analog OUT ready for teaching.**

## 1-point teach of the analog output

First activate the previously described teach mode for output Analog OUT.

By selecting an object distance within the scanning range, the characteristic curve of the analog output can be adjusted.

If an object is located outside of the taught measurement range, an error signal is output. A different analog signal is output here by the sensor for the errors "distance too close: object outside of the measurement range" and "distance too far: object outside of the measurement range".

### 1-point teach - rising characteristic curve

<b>1. Place</b> object at desired distance for the end point of the measurement range. <b>Note:</b> The <b>minimum object distance for the end of the measurement range</b> is as follows: scanning range of 400mm: <b>90mm</b> scanning range of 1600mm: <b>310mm</b>
<b>2.</b> To adjust analog output <b>Analog OUT</b> , <b>press the teach button for 2 ... 7s</b> until the <b>blue and green LEDs flash simultaneously at 3Hz</b> .
<b>3. Release the button.</b> The characteristic curve with plot rising from the start of the range (50 mm or 150 mm) to the set object distance was taught in.
<b>4.</b> Error-free teach: LED states acc. to "Technical data" -> "Indicators". <b>Faulty teach: green and blue LEDs flash at 8Hz</b> until an error-free teach is performed.

## 2-point teach of the analog output

First activate the previously described teach mode for output Analog OUT.

By selecting 2 object distances within the scanning range, the characteristic curve of the analog output can be adjusted.

If an object is located outside of the taught measurement range, an error signal is output. A different analog signal is output here by the sensor for the errors "distance too close: object outside of the measurement range" and "distance too far: object outside of the measurement range".

### 2-point teach - rising characteristic curve

<b>1. Position</b> the object at the first desired distance (near or far).
<b>2.</b> To adjust analog output <b>Analog OUT</b> , <b>press the teach button for 7 ... 12s</b> until the <b>blue and green LEDs flash alternately at 3Hz</b> .
<b>3. Release the button.</b> The sensor remains in teach mode and the LEDs continue to flash.
<b>4.</b> Then <b>position</b> the object at the second desired distance (far or near). <b>Note:</b> the <b>minimum object distance between the start and end point of the measurement range</b> for a scanning range of 400mm is: <b>40mm</b> for a scanning range of 1600mm is: <b>160mm</b>
<b>5. Briefly press the teach button</b> again to complete the teach event. The characteristic curve with rising plot from the near to the far object distance was taught in.
<b>6.</b> Error-free teach: LED states acc. to "Technical data" -> "Indicators". <b>Faulty teach: green and blue LEDs flash at 8Hz</b> until an error-free teach is performed.

## Inverting the analog output (falling/rising characteristic curve)

First activate the previously described teach mode for output Analog OUT.

The characteristic curve of the analog output can be inverted, e.g., if a falling characteristic output curve is desired.

### Inverting the characteristic curve

<b>1.</b> To invert the characteristic curve of the analog output <b>Analog OUT</b> , <b>press the teach button for &gt; 12s</b> until the <b>blue and green LEDs flash alternately</b> .
<b>2. Release the button.</b> The characteristic curve plot was inverted. The <b>blue LED</b> indicates the current setting of the analog output: <b>ON</b> = <b>rising</b> characteristic curve <b>OFF</b> = <b>falling</b> characteristic curve



**DMU318...W 90° angled ultrasonic sensors with analog and switching output**

**Synchronization of multiple DMU318 ultrasonic sensors**

If adjacent ultrasonic sensors receive the signals of other sensors, so-called crosstalk occurs, which leads to faulty measurement results. Through temporal synchronization of the adjacent sensors, this can be avoided. Via the **Sync/MUX** input, the DMU318 ultrasonic sensors can be synchronized in 2 different ways:

**Synchronous operation**

In this operating mode the mutual interference of adjacent sensors can be avoided. For this purpose, up to 6 sensors of the same type are wired together in a network according to the following diagram.

The devices work in synchronous operation with a **simultaneous transmission pulse**. The response time of the individual sensors in the network corresponds approximately to that of a single sensor. However, an additional delay time of approx. 20ms occurs in comparison to the specified response time in standard operation.

*Synchronous operation wiring schematic*

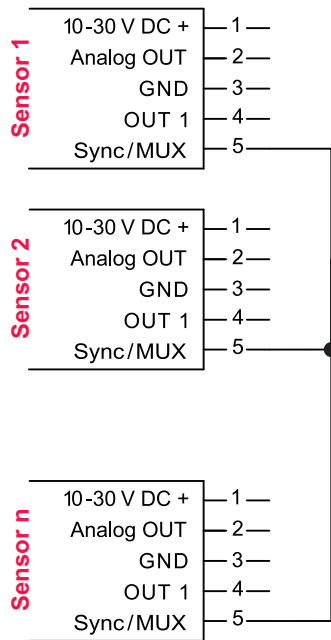

	<p><b>NOTE</b></p> <p>Please make certain that the wiring is performed according to the connection diagram. <b>Sync/MUX</b> pin 5 on all sensors in the network must be connected to one another. Generation of the synchronization signal for all sensors in the network occurs automatically.</p>
---	---

### Multiplex operation

In this operating mode the mutual interference of adjacent sensors can be reliably avoided. For this purpose, up to 4 sensors of the same type are wired together in a network according to the following diagram.

The devices operate in multiplex operation with a **cyclically time-delayed transmission pulse** and are switched to a passive state outside of the active phase, whereby the states of the outputs are frozen until the next active phase. The response time of the individual sensor in the network is therefore extended with respect to the response time of a single sensor as follows:

**Response time in the network = (Response time of sensor \* n) + 25ms** (n = number of sensors in the network)

Multiplex operation wiring schematic

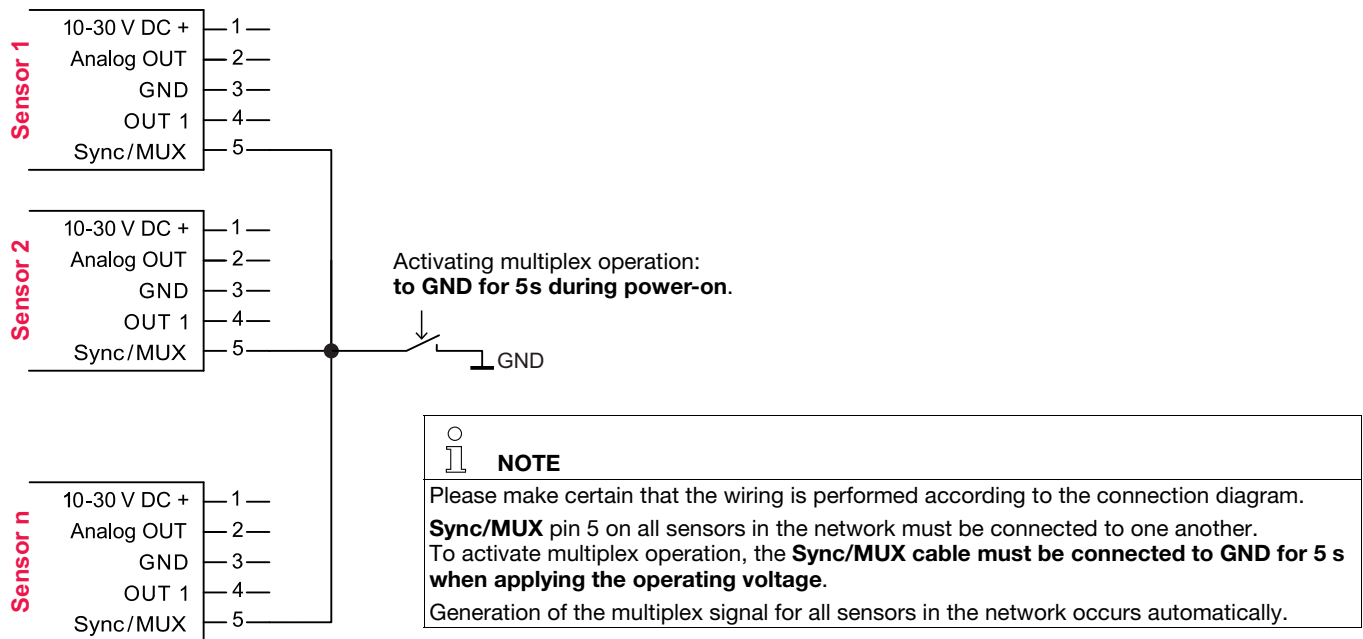

### Resetting to factory settings

The sensor can be reset to the factory setting (1 switching point at 400mm or 1600mm, rising characteristic curve with spread over the entire scanning range).

Resetting to factory settings
<b>1. When switching on the supply voltage (during power-on), press the teach button for &gt; 5s.</b>
<b>2. Release the button.</b> The <b>green, yellow and blue LEDs</b> flash <b>alternately and very quickly</b> for a brief time.
The sensor was reset to the factory setting:
<b>switching output:</b> 1 switching point at 400mm or 1600mm (1-point teach, static),
<b>analog output:</b> 4 ... 20mA or 0 ... 10V corresponds to an object distance of 50 ... 400 mm or 150 ... 1600 mm, respectively.