



Part no.: 50135463
A7-MP1-100
Signaling column element



Figure can vary

Contents

- Technical data
- Dimensioned drawings
- Electrical connection
- Accessories

Part no.: 50135463 – A7-MP1-100 – Signaling column element

Technical data

Basic data

Series	A7
--------	----

Connection

Connection 1

Type of connection	Terminal
Type of terminal	Tension spring technology

Mechanical data

Design	Cylindrical
Dimension (Ø x L)	70 mm x 132 mm
Housing material	Metal Plastic
Housing color	Gray Black
Design of mounting device	Base mounting
Type of fastening, at system	Screw type / horizontal
Module holder	One side
Number of end caps	1 Piece(s)

Environmental data

Ambient temperature, operation	-10 ... 60 °C
--------------------------------	---------------

Certifications

Degree of protection	IP 66
----------------------	-------

Classification

Customs tariff number	85318070
eCl@ss 8.0	27371234
eCl@ss 9.0	27371234
ETIM 5.0	EC001259
ETIM 6.0	EC001259

Dimensioned drawings

All dimensions in millimeters

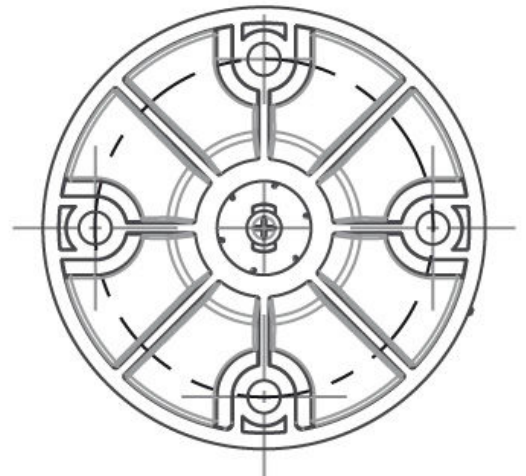
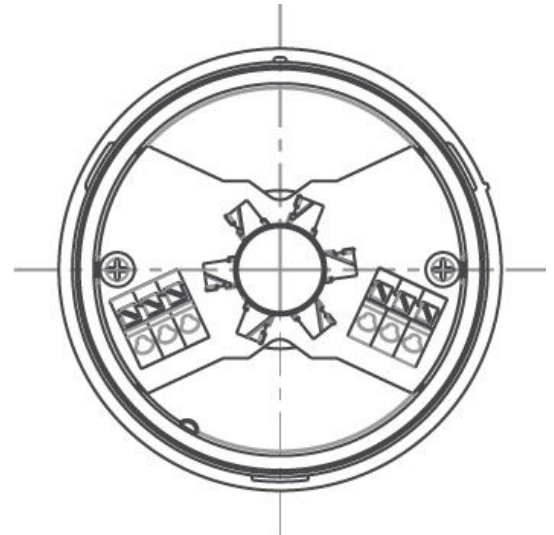
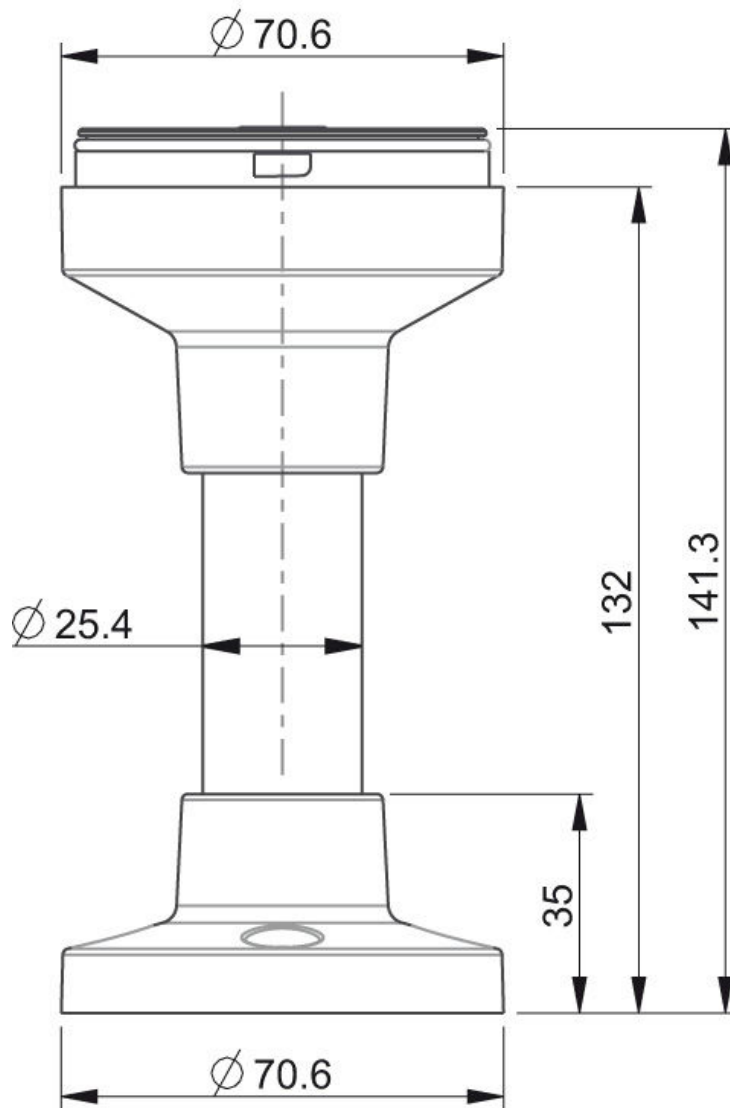

Electrical connection

Connection 1	
Type of connection	Terminal
Function	Voltage supply
Type of terminal	Tension spring technology

Accessories



Mounting technology - Mounting brackets

	Part no.	Designation	Article	Description
	50137729	A7-MW1	Signaling column element	Design: Bracket mounting Fastening, at system: Screw type / vertical Lens modules: Max. 5 pieces Module holder: One side Ambient temperature: -10 ... 60 °C Degree of protection: IP 66

General

	Part no.	Designation	Article	Description
	50135462	A7-V1-BZ1-M	Signaling column element	Signaling: Acoustic Current consumption, max.: 70 mA Design: Cylindrical Diameter: 70 mm Fastening: Bayonet system Operational controls: DIP switch, 225° potentiometer Ambient temperature: -10 ... 60 °C Degree of protection: IP 66 Tone type: Continuous or pulse tone Sound pressure: 100 dB Number of tones: 8 Piece(s)
	50138151	A7-V1-BZ2-S	Signaling column element	Signaling: Acoustic Current consumption, max.: 20 mA Design: Cylindrical Diameter: 70 mm Fastening: Bayonet system Operational controls: 225° potentiometer Ambient temperature: -10 ... 60 °C Degree of protection: IP 66 Tone type: Continuous tone Sound pressure: 105 dB Number of tones: 1 Piece(s)
	50135460	A7-V1-DS-B-T	Signaling column element	Signaling: Optical Current consumption, max.: 40 mA Design: Cylindrical Diameter: 70 mm Fastening: Bayonet system Illuminant: LED/24V Signal image: Continuous light Lens color: Blue Angle of radiation: 360° Ambient temperature: -10 ... 60 °C Degree of protection: IP 66
	50135459	A7-V1-DS-G-T	Signaling column element	Signaling: Optical Current consumption, max.: 30 mA Design: Cylindrical Diameter: 70 mm Fastening: Bayonet system Illuminant: LED/24V Signal image: Continuous light Lens color: Green Angle of radiation: 360° Ambient temperature: -10 ... 60 °C Degree of protection: IP 66
	50135458	A7-V1-DS-O-T	Signaling column element	Signaling: Optical Current consumption, max.: 50 mA Design: Cylindrical Diameter: 70 mm Fastening: Bayonet system Illuminant: LED/24V Signal image: Continuous light Lens color: Orange Angle of radiation: 360° Ambient temperature: -10 ... 60 °C Degree of protection: IP 66

Part no.: 50135463 – A7-MP1-100 – Signaling column element

	Part no.	Designation	Article	Description
	50135457	A7-V1-DS-R-T	Signaling column element	<p>Signaling: Optical Current consumption, max.: 50 mA Design: Cylindrical Diameter: 70 mm Fastening: Bayonet system Illuminant: LED/24V Signal image: Continuous light Lens color: Red Angle of radiation: 360° Ambient temperature: -10 ... 60 °C Degree of protection: IP 66</p>
	50135461	A7-V1-DS-W-T	Signaling column element	<p>Signaling: Optical Current consumption, max.: 40 mA Design: Cylindrical Diameter: 70 mm Fastening: Bayonet system Illuminant: LED/24V Signal image: Continuous light Lens color: Clear Angle of radiation: 360° Ambient temperature: -10 ... 60 °C Degree of protection: IP 66</p>