



**Part no.: 50135054**  
**BCL 338i R1 F 100**  
**Stationary bar code reader**



EtherCAT



Figure can vary

## Contents

- Technical data
- Dimensioned drawings
- Electrical connection
- Diagrams
- Operation and display
- Part number code
- Notes
- Accessories

## Technical data

<b>Basic data</b>	
Series	BCL 300i
<b>Functions</b>	
Functions	Code fragment technology Reference code comparison LED indicator AutoControl AutoReflAct Alignment mode AutoConfig
<b>Characteristic parameters</b>	
MTTF	110 years
<b>Read data</b>	
Code types, readable	EAN 8/13 GS1 Databar Omnidirectional Codabar Code 128 UPC Code 93 GS1 Databar Expanded 2/5 Interleaved Code 39 GS1 Databar Limited
Scanning rate, typical	1,000 scans/s
Bar codes per reading gate, max. number	64 Piece(s)
<b>Optical data</b>	
Reading distance	70 ... 440 mm
Light source	Laser, Red
Laser light wavelength	655 nm
Laser class	2, IEC/EN 60825-1:2007
Transmitted-signal shape	Continuous
Usable opening angle (reading field opening)	60 °
Module size	0.3 ... 0.5 mm
Reading method	Raster scanner with deflecting mirror
Beam deflection	By means of rotating polygon mirror wheel + deflecting mirror
Light beam exit	Lateral with deflecting mirror
Raster (number of lines)	8 Piece(s)
Scanning field at scanner distance of 100 mm	17 mm
Scanning field at scanner distance of 200 mm	27 mm
Scanning field at scanner distance of 300 mm	38 mm
Scanning field at scanner distance of 400 mm	48 mm
<b>Electrical data</b>	
Protective circuit	Polarity reversal protection
<b>Performance data</b>	
Supply voltage $U_B$	18 ... 30 V, DC
Power consumption, max.	4.5 W

**Part no.: 50135054 – BCL 338i R1 F 100 – Stationary bar code reader**
**Inputs/outputs selectable**

Output current, max.	60 mA
Number of inputs/outputs selectable	2 Piece(s)
Input current, max.	8 mA

**Interface**

Type	EtherCAT
------	----------

**EtherCAT**

Function	Process
Transmission protocol	EtherCAT, CoE and EoE

**Service interface**

Type	USB
------	-----

**USB**

Function	Configuration via software Service
----------	---------------------------------------

**Connection**

Number of connections	1 Piece(s)
-----------------------	------------

**Connection 1**

Type of connection	Plug connector
Function	BUS OUT PWR / SW IN/OUT Service interface BUS IN Connection to device Data interface
No. of pins	32 -pin
Type	Male

**Mechanical data**

Design	Cubic
Dimension (W x H x L)	103 mm x 44 mm x 96 mm
Housing material	Metal, Diecast aluminum
Lens cover material	Glass
Net weight	350 g
Housing color	Black Red
Type of fastening	Fastening on back Dovetail grooves Via optional mounting device

**Operation and display**

Type of display	LED
Number of LEDs	2 Piece(s)
Type of configuration	Via web browser

**Environmental data**

Ambient temperature, operation	0 ... 40 °C
Ambient temperature, storage	-20 ... 70 °C
Relative humidity (non-condensing)	0 ... 90 %

**Certifications**

Degree of protection	IP 65
Protection class	III
Certifications	c UL US
Test procedure for EMC in accordance with standard	EN 61000-4-2, 3, -4, -6 EN 55022
Test procedure for shock in accordance with standard	IEC 60068-2-27, test Ea
Test procedure for continuous shock in accordance with standard	IEC 60068-2-29, test Eb
Test procedure for vibration in accordance with standard	IEC 60068-2-6, test Fc

**Classification**

eCl@ss 8.0	27280102
eCl@ss 9.0	27280102
ETIM 5.0	EC002550
ETIM 6.0	EC002550

## Dimensioned drawings

All dimensions in millimeters

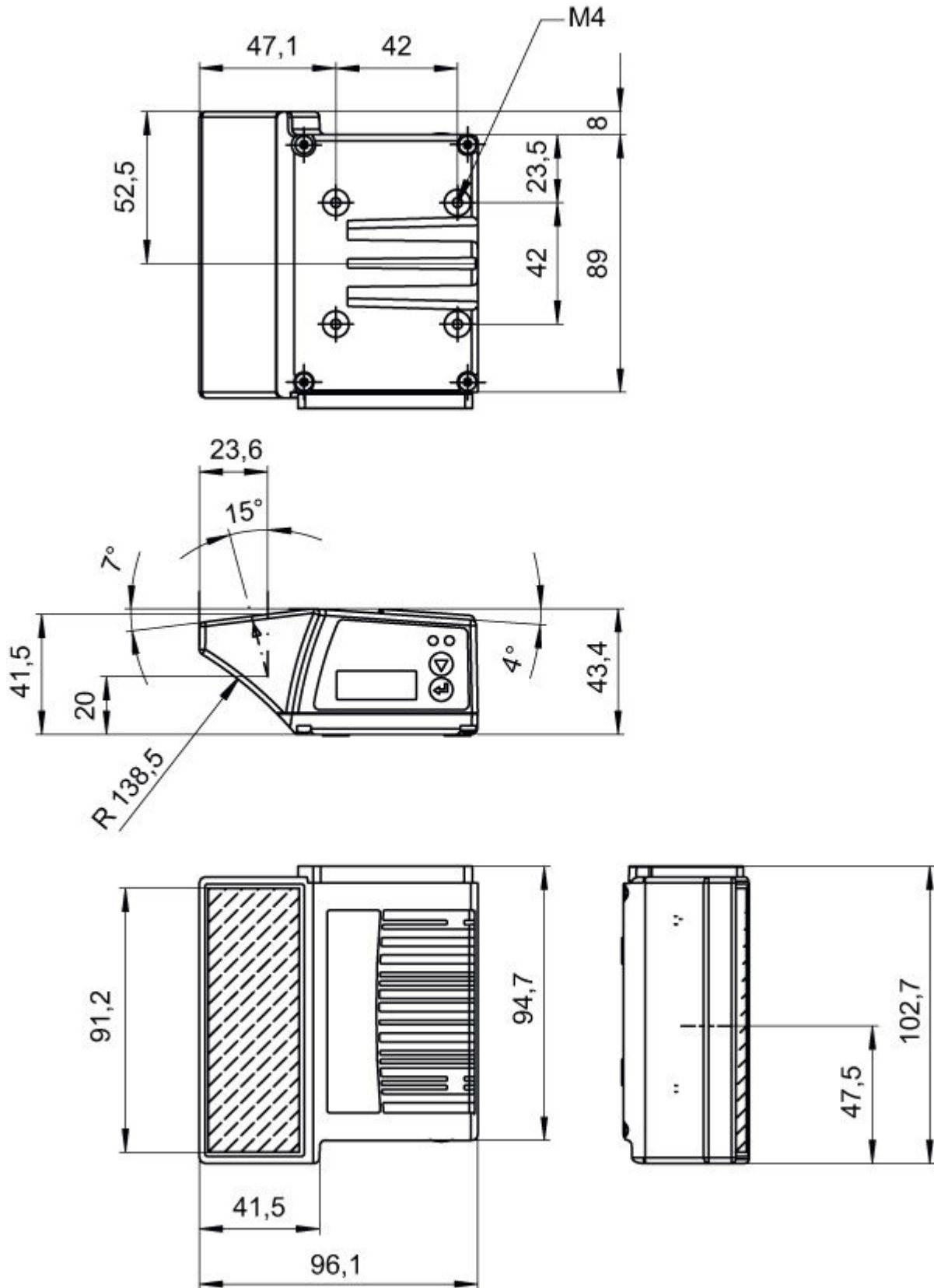

## Electrical connection

Connection 1	
Type of connection	Plug connector
Function	BUS OUT PWR / SW IN/OUT Service interface BUS IN Connection to device Data interface
No. of pins	32 -pin
Type	Male

## Diagrams

### Reading field curve

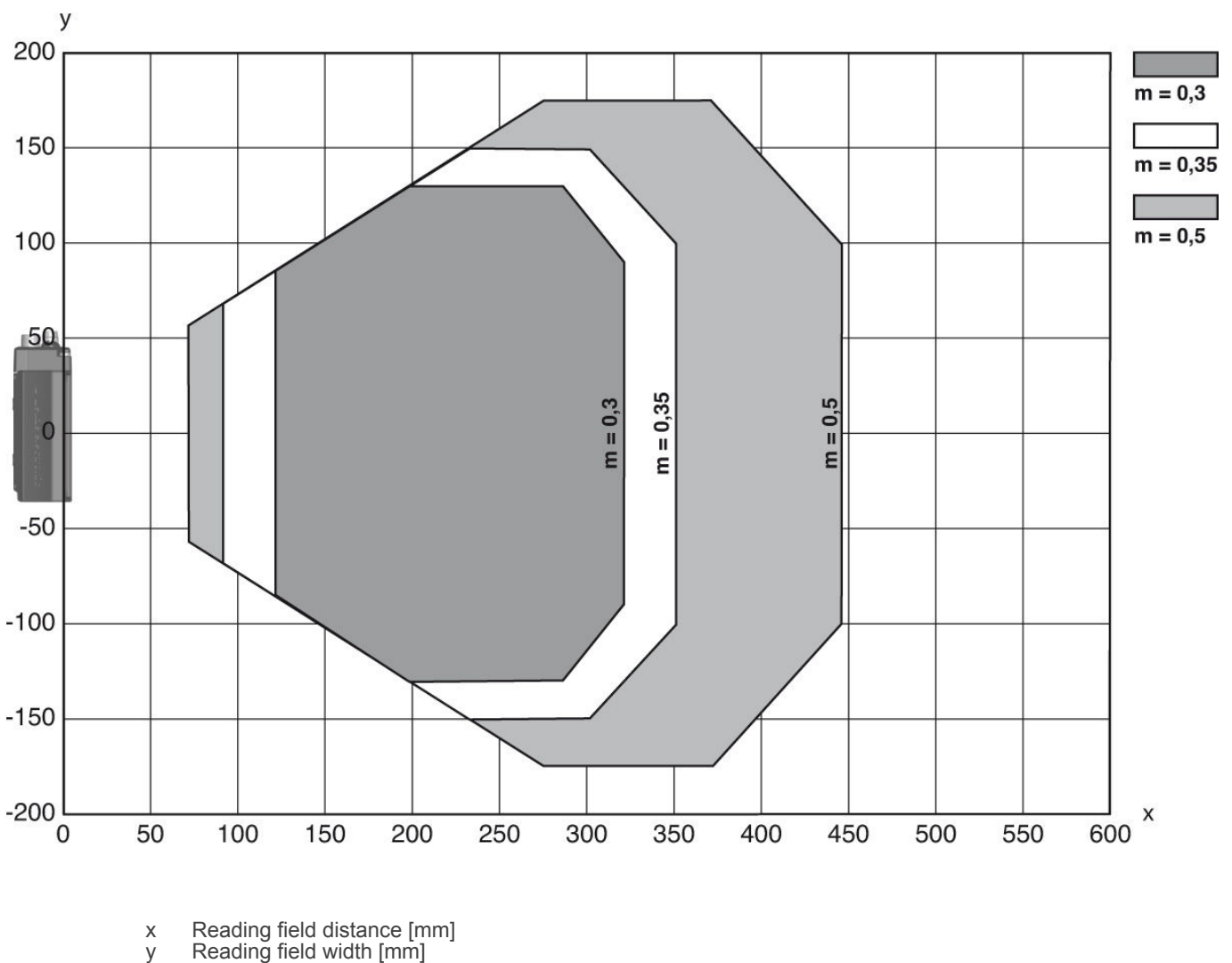

## Operation and display

### LEDs

LED	Display	Meaning	
1	PWR	Green, flashing	Device ok, initialization phase
		Green, continuous light	Device OK
		Green, briefly off - on	Reading successful
		green, briefly off - briefly red - on	Reading not successful
		Orange, continuous light	Service mode
		Red, flashing	Device OK, warning set
		Red, continuous light	Error, device error
2	BUS	Green, flashing	Initialization
		Green, continuous light	Bus operation ok
		Red, flashing	Communication error
		Red, continuous light	Bus error

## Part number code

Part designation: **BCL XXXX YYZ AAA BB**

BCL	<b>Operating principle:</b> BCL: bar code reader
XXXX	<b>Series/interface (integrated fieldbus technology):</b> 300i: RS 232 / RS 422 (stand-alone) 301i: RS 485 (multiNet slave) 304i: PROFIBUS DP 308i: EtherNet TCP/IP, UDP 348i: PROFINET RT 358i: EtherNet/IP
YY	<b>Scanning principle:</b> S: line scanner (single line) R1: line scanner (raster) O: oscillating-mirror scanner (oscillating mirror)
Z	<b>Optics:</b> N: High Density (close) M: Medium Density (medium distance) F: Low Density (remote) L: Long Range (very large distances) J: ink-jet (depending on the application)
AAA	<b>Beam exit:</b> 100: lateral 102: front
BB	<b>Special equipment:</b> D: with display H: with heating DH: optionally with display and heating P: plastic exit window

## Notes

Observe intended use!
<ul style="list-style-type: none"> <li>This product is not a safety sensor and is not intended as personnel protection.</li> <li>The product may only be put into operation by competent persons.</li> <li>Only use the product in accordance with its intended use.</li> </ul>

**WARNING! LASER RADIATION – LASER CLASS 2**

**Never look directly into the beam!**

The device satisfies the requirements of IEC 60825-1:2007 (EN 60825-1:2007) safety regulations for a product of **laser class 2** as well as the U.S. 21 CFR 1040.10 regulations with deviations corresponding to "Laser Notice No. 50" from June 24, 2007.

- Never look directly into the laser beam or in the direction of reflected laser beams! If you look into the beam path over a longer time period, there is a risk of injury to the retina.
- Do not point the laser beam of the device at persons!
- Interrupt the laser beam using a non-transparent, non-reflective object if the laser beam is accidentally directed towards a person.
- When mounting and aligning the device, avoid reflections of the laser beam off reflective surfaces!
- CAUTION! Use of controls or adjustments or performance of procedures other than specified herein may result in hazardous light exposure.
- Observe the applicable statutory and local laser protection regulations.
- The device must not be tampered with and must not be changed in any way.  
There are no user-serviceable parts inside the device.  
Repairs must only be performed by Leuze electronic GmbH + Co. KG.

**NOTE**



**Affix laser information and warning signs!**

Laser information and warning signs are affixed to the device. In addition, self-adhesive laser information and warning signs (stick-on labels) are supplied in several languages.

- Affix the laser information sheet to the device in the language appropriate for the place of use. When using the device in the US, use the stick-on label with the "Complies with 21 CFR 1040.10" note.
- Affix the laser information and warning signs near the device if no signs are attached to the device (e.g. because the device is too small) or if the attached laser information and warning signs are concealed due to the installation position.
- Affix the laser information and warning signs so that they are legible without exposing the reader to the laser radiation of the device or other optical radiation.







## Accessories

### Connection technology - Connection cables

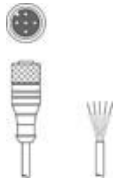
	Part no.	Designation	Article	Description
	50132077	KD U-M12-5A-V1-020	Connection cable	Connection 1: Connector, M12, Axial, Female, A-coded, 5 -pin Connection 2: Open end Shielded: No Cable length: 2,000 mm Sheathing material: PVC
	50132079	KD U-M12-5A-V1-050	Connection cable	Connection 1: Connector, M12, Axial, Female, A-coded, 5 -pin Connection 2: Open end Shielded: No Cable length: 5,000 mm Sheathing material: PVC
	50132080	KD U-M12-5A-V1-100	Connection cable	Connection 1: Connector, M12, Axial, Female, A-coded, 5 -pin Connection 2: Open end Shielded: No Cable length: 10,000 mm Sheathing material: PVC



**Part no.: 50135054 – BCL 338i R1 F 100 – Stationary bar code reader**

	Part no.	Designation	Article	Description
	50132432	KD U-M12-5A-V1-300	Connection cable	Connection 1: Connector, M12, Axial, Female, A-coded, 5 -pin Connection 2: Open end Shielded: No Cable length: 30,000 mm Sheathing material: PVC
	50135073	KS ET-M12-4A-P7-020	Connection cable	Suitable for interface: Ethernet Connection 1: Connector, M12, Axial, Male, D-coded, 4 -pin Connection 2: Open end Shielded: Yes Cable length: 2,000 mm Sheathing material: PUR
	50135074	KS ET-M12-4A-P7-050	Connection cable	Suitable for interface: Ethernet Connection 1: Connector, M12, Axial, Male, D-coded, 4 -pin Connection 2: Open end Shielded: Yes Cable length: 5,000 mm Sheathing material: PUR
	50135075	KS ET-M12-4A-P7-100	Connection cable	Suitable for interface: Ethernet Connection 1: Connector, M12, Axial, Male, D-coded, 4 -pin Connection 2: Open end Shielded: Yes Cable length: 10,000 mm Sheathing material: PUR
	50135076	KS ET-M12-4A-P7-150	Connection cable	Suitable for interface: Ethernet Connection 1: Connector, M12, Axial, Male, D-coded, 4 -pin Connection 2: Open end Shielded: Yes Cable length: 15,000 mm Sheathing material: PUR
	50135077	KS ET-M12-4A-P7-300	Connection cable	Suitable for interface: Ethernet Connection 1: Connector, M12, Axial, Male, D-coded, 4 -pin Connection 2: Open end Shielded: Yes Cable length: 30,000 mm Sheathing material: PUR

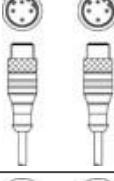
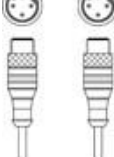

**Connection technology - Interconnection cables**

	Part no.	Designation	Article	Description
	50117011	KB USB A - USB miniB	Service line	Suitable for interface: USB Connection 1: USB Connection 2: USB Shielded: Yes Cable length: 1,500 mm Sheathing material: PVC
	50137077	KSS ET-M12-4A-M12-4A-P7-020	Interconnection cable	Suitable for interface: Ethernet Connection 1: Connector, M12, Axial, Male, D-coded, 4 -pin Connection 2: Connector, M12, Axial, Male, D-coded, 4 -pin Shielded: Yes Cable length: 1,000 mm Sheathing material: PUR
	50137078	KSS ET-M12-4A-M12-4A-P7-050	Interconnection cable	Suitable for interface: Ethernet Connection 1: Connector, M12, Axial, Male, D-coded, 4 -pin Connection 2: Connector, M12, Axial, Male, D-coded, 4 -pin Shielded: Yes Cable length: 1,000 mm Sheathing material: PUR

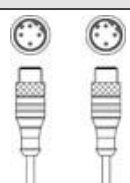
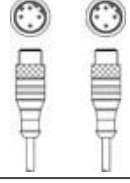
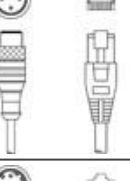
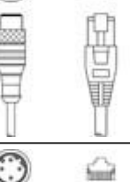
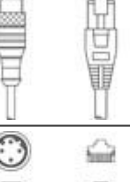
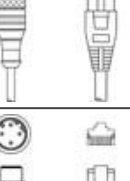
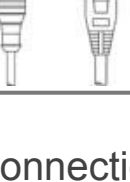
Part no.: 50135054 – BCL 338i R1 F 100 – Stationary bar code reader

	Part no.	Designation	Article	Description
	50137079	KSS ET-M12-4A-M12-4A-P7-100	Interconnection cable	Suitable for interface: Ethernet Connection 1: Connector, M12, Axial, Male, D-coded, 4 -pin Connection 2: Connector, M12, Axial, Male, D-coded, 4 -pin Shielded: Yes Cable length: 10,000 mm Sheathing material: PUR
	50137080	KSS ET-M12-4A-M12-4A-P7-150	Interconnection cable	Suitable for interface: Ethernet Connection 1: Connector, M12, Axial, Male, D-coded, 4 -pin Connection 2: Connector, M12, Axial, Male, D-coded, 4 -pin Shielded: Yes Cable length: 15,000 mm Sheathing material: PUR
	50135080	KSS ET-M12-4A-RJ45-A-P7-020	Interconnection cable	Suitable for interface: Ethernet Connection 1: Connector, M12, Axial, Male, D-coded, 4 -pin Connection 2: RJ45 Shielded: Yes Cable length: 2,000 mm Sheathing material: PUR
	50135081	KSS ET-M12-4A-RJ45-A-P7-050	Interconnection cable	Suitable for interface: Ethernet Connection 1: Connector, M12, Axial, Male, D-coded, 4 -pin Connection 2: RJ45 Shielded: Yes Cable length: 5,000 mm Sheathing material: PUR
	50135082	KSS ET-M12-4A-RJ45-A-P7-100	Interconnection cable	Suitable for interface: Ethernet Connection 1: Connector, M12, Axial, Male, D-coded, 4 -pin Connection 2: RJ45 Shielded: Yes Cable length: 10,000 mm Sheathing material: PUR
	50135083	KSS ET-M12-4A-RJ45-A-P7-150	Interconnection cable	Suitable for interface: Ethernet Connection 1: Connector, M12, Axial, Male, D-coded, 4 -pin Connection 2: RJ45 Shielded: Yes Cable length: 15,000 mm Sheathing material: PUR
	50135084	KSS ET-M12-4A-RJ45-A-P7-300	Interconnection cable	Suitable for interface: Ethernet Connection 1: Connector, M12, Axial, Male, D-coded, 4 -pin Connection 2: RJ45 Shielded: Yes Cable length: 30,000 mm Sheathing material: PUR





## Connection technology - Connectors

	Part no.	Designation	Article	Description
	50108991	D-ET1	Connector	Suitable for interface: Ethernet Connection: RJ45
	50020501	KD 095-5A	Connector	Connection: Connector, M12, Axial, Female, A-coded, 5 -pin

**Part no.: 50135054 – BCL 338i R1 F 100 – Stationary bar code reader**

	Part no.	Designation	Article	Description
	50112155	S-M12A-ET	Connector	Suitable for interface: Ethernet Connection: Connector, M12, Axial, Male, D-coded, 4 -pin

**Connection technology - Terminal boxes**

	Part no.	Designation	Article	Description
	50134929 *	ME 338 103	Connection unit	Suitable for: BCL 338i, BPS 338i Suitable for interface: EtherCAT Number of connections: 4 Piece(s) Connection: Cable with connector, M12, 900 mm
	50134927 *	ME 338 104	Connection unit	Suitable for: BCL 348i Suitable for interface: PROFINET Number of connections: 5 Piece(s) Connection: Cable with connector, M12, 900 mm
	50134928 *	ME 338 214	Connection unit	Suitable for: BCL 348i Suitable for interface: PROFINET Number of connections: 5 Piece(s) Connection: Cable with connector, M12, 600 mm
	50134931 *	MK 338	Connection unit	Suitable for: BCL 338i, BPS 338i Suitable for interface: EtherCAT Number of connections: 4 Piece(s) Connection: Terminal
	50134930 *	MS 338	Connection unit	Suitable for: BCL 338i, BPS 338i Suitable for interface: EtherCAT Number of connections: 4 Piece(s) Connection: Connector, M12

\* Necessary accessories, please order separately

**Connection technology - Adapters**



	Part no.	Designation	Article	Description
	50109832	KDS ET-M12 / RJ45 W-4P	Adapter	Suitable for: Ethernet Number of connections: 2 Piece(s) Connection 1: Connector, M12, Angled, Female, D-coded, 4 -pin Connection 2: RJ45

**Mounting technology - Mounting brackets**



	Part no.	Designation	Article	Description
	50121433	BT 300 W	Mounting device	Contains: 4x M4 x 10 screw, 4x position washers, 4x lock washers Design of mounting device: Angle, L-shape Fastening, at system: Through-hole mounting Mounting bracket, at device: Screw type Type of mounting device: Adjustable Material: Metal

Part no.: 50135054 – BCL 338i R1 F 100 – Stationary bar code reader

## Mounting technology - Rod mounts

	Part no.	Designation	Article	Description
	50121434	BT 300 - 1	Mounting device	Contains: 4x M4 x 10 screw, 4x position washers, 4x lock washers Design of mounting device: Mounting system Fastening, at system: For 12 mm rod, For 14 mm rod, For 16 mm rod Mounting bracket, at device: Screw type Type of mounting device: Turning, 360°, Adjustable Material: Metal
	50027375	BT 56	Mounting device	Functions: Static applications Design of mounting device: Mounting system Fastening, at system: For 16 mm rod, For 18 mm rod, For 20 mm rod Mounting bracket, at device: Clampable Material: Metal Tightening torque of the clamping jaws: 8 N·m
	50121435	BT 56 - 1	Mounting device	Functions: Static applications Design of mounting device: Mounting system Fastening, at system: For 12 mm rod, For 14 mm rod, For 16 mm rod Mounting bracket, at device: Clampable Material: Metal Tightening torque of the clamping jaws: 8 N·m

## Mounting technology - Other

	Part no.	Designation	Article	Description
	50111224	BT 59	Mounting bracket	Fastening, at system: Groove mounting Mounting bracket, at device: Clampable Material: Metal
	50124941	BTU 0300M-W	Mounting device	Fastening, at system: Through-hole mounting Mounting bracket, at device: Clampable, Groove mounting Material: Metal





## Reflective tapes for standard applications

	Part no.	Designation	Article	Description
	50106119	REF 4-A-100x100	Reflective tape	Design: Rectangular Reflective surface: 100 mm x 100 mm Material: Plastic Chemical designation of the material: PMMA Fastening: Self-adhesive

## General

	Part no.	Designation	Article	Description
	50120731	Housing BCL 300i V2A	Protective housing	Suitable for: BCL 3xxi series bar code reader, deflecting mirror Length: 63 mm Housing material: Stainless steel Standard designation, housing: V2A Lens cover material: Glass Degree of protection: IP 67, IP 69K

## Services

	Part no.	Designation	Article	Description
	S981020	CS30-E-212		Details: Compilation of the application data, selection and suggestion of suitable sensor system, drawing prepared as assembly sketch. Conditions: Completed questionnaire or project specifications with a description of the application have been provided. Restrictions: Travel and accommodation charged separately and according to expenditure.
	S981014	CS30-S-110	Start-up support	Details: Performed at location of customer's choosing, duration: max. 10 hours. Conditions: Devices and connection cables are already mounted, price not including travel costs and, if applicable, accommodation expenses. Restrictions: No mechanical (mounting) and electrical (wiring) work performed, no changes (attachments, wiring, programming) to third-party components in the nearby environment.
	S981019	CS30-T-110	Product training	Details: Location and content to be agreed upon, duration: max. 10 hours. Conditions: Price not including travel costs and, if applicable, accommodation expenses. Restrictions: Travel costs and accommodation expenses charged separately and according to expenditure.
	S981021	CS30-V-212		Details: REA evaluation with creation of a test report, evaluation of the code quality. Conditions: Original bar codes to be provided by the client.