



Figure can vary

**Part no.: 50134379**

**PRK15.D1/4**

**Polarized retro-reflective photoelectric sensor**



## Contents

- Technical data
- Dimensioned drawings
- Electrical connection
- Diagrams
- Operation and display
- Reflectors & reflective tapes
- Part number code
- Notes
- Accessories

## Technical data

<b>Basic data</b>	
Series	15
Operating principle	Reflection principle
Application	Detection of stretch-wrapped objects

<b>Optical data</b>	
Operating range	Guaranteed operating range
Operating range	0 ... 6 m, With reflector TK(S) 100x100
Operating range limit	Typical operating range
Operating range limit	0 ... 8 m, With reflector TK(S) 100x100
Light source	LED, Red
LED light wavelength	640 nm
Transmitted-signal shape	Pulsed
LED group	Exempt group (in acc. with EN 62471)

<b>Electrical data</b>	
Protective circuit	Polarity reversal protection Short circuit protected

<b>Performance data</b>	
Supply voltage $U_B$	10 ... 30 V, DC, Incl. residual ripple
Residual ripple	0 ... 15 %, From $U_B$
Open-circuit current	0 ... 20 mA

<b>Outputs</b>	
Number of digital switching outputs	1 Piece(s)

<b>Switching outputs</b>	
Voltage type	DC
Switching current, max.	100 mA
Switching voltage	high: $\geq(U_B - 2.5V)$ low: $\leq 2.5V$

<b>Switching output 1</b>	
Switching element	Transistor, PNP
Switching principle	Light switching

<b>Timing</b>	
Switching frequency	500 Hz
Response time	1 ms
Readiness delay	300 ms

<b>Connection</b>	
<b>Connection 1</b>	
Type of connection	Cable
Function	Voltage supply Signal OUT
Cable length	2,000 mm
Sheathing material	PUR
Cable color	Black
Number of conductors	3 -wire
Wire cross section	0.14 mm <sup>2</sup>

**Mechanical data**

Dimension (W x H x L)	15 mm x 42.7 mm x 30 mm
Housing material	Plastic, ABS
Lens cover material	Plastic
Net weight	37 g
Housing color	Black
Type of fastening	Through-hole mounting Via optional mounting device

**Operation and display**

Type of display	LED
Number of LEDs	1 Piece(s)
Operational controls	270° potentiometer
Function of the operational control	Sensitivity adjustment

**Environmental data**

Ambient temperature, operation	-40 ... 60 °C
Ambient temperature, storage	-40 ... 70 °C

**Certifications**

Degree of protection	IP 67
Protection class	III
Certifications	c UL US
Standards applied	IEC 60947-5-2

**Classification**

Customs tariff number	85365019
eCl@ss 8.0	27270902
eCl@ss 9.0	27270902
ETIM 5.0	EC002717
ETIM 6.0	EC002717

## Dimensioned drawings

All dimensions in millimeters

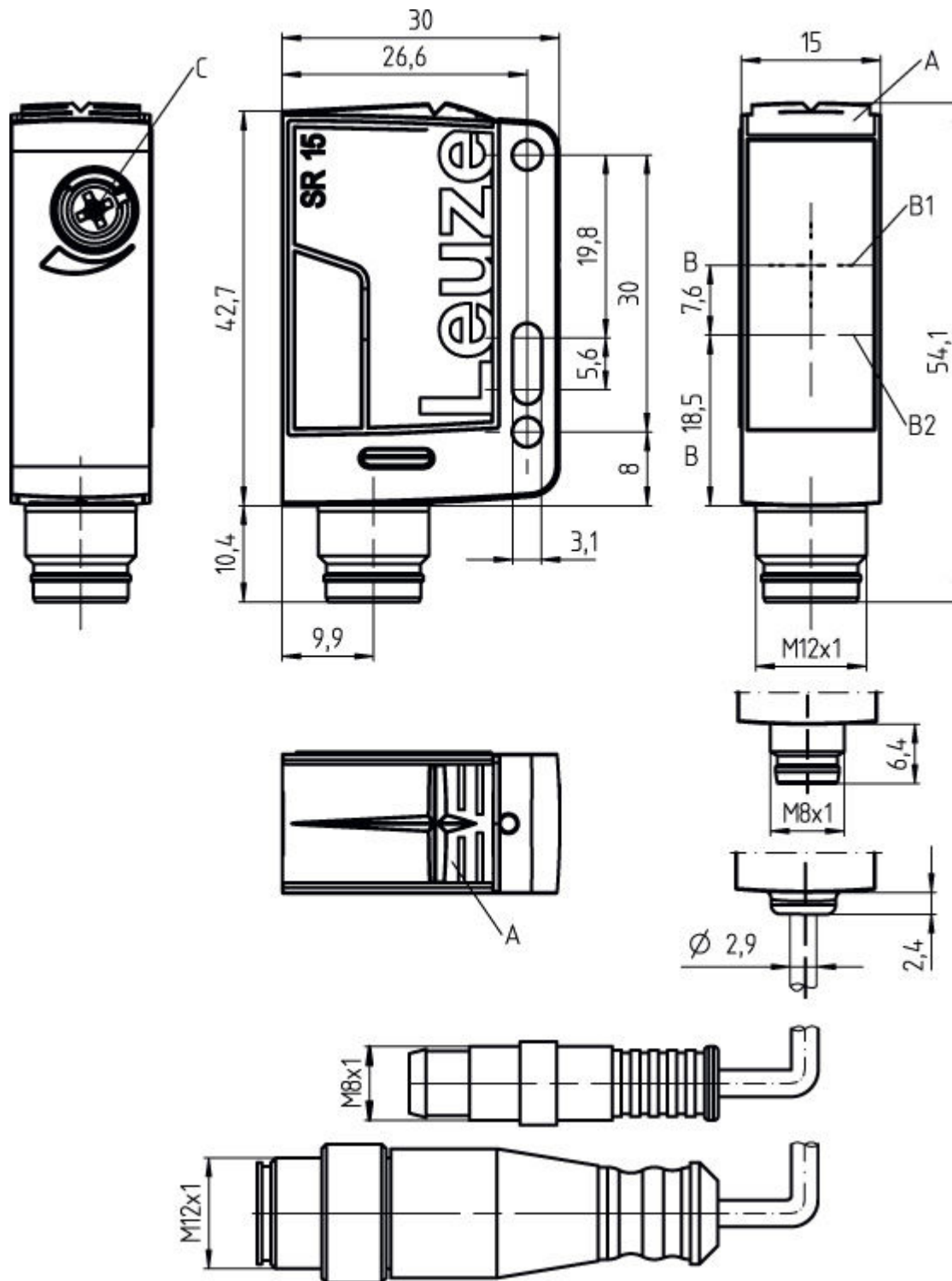

- A Yellow LED
- B Optical axis
- B1 Receiver
- B2 Transmitter
- C Sensitivity adjustment

## Electrical connection

Connection 1	
Type of connection	Cable
Function	Voltage supply Signal OUT
Cable length	2,000 mm
Sheathing material	PUR
Cable color	Black
Number of conductors	3 -wire
Wire cross section	0.14 mm <sup>2</sup>

Conductor color	Conductor assignment
Brown	V+
Blue	GND
Black	OUT 1

## Diagrams

Typ. function reserve

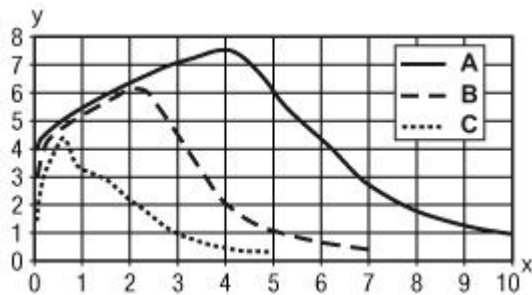

x Distance [m]  
y Function reserve  
A TKS 100x100  
B TKS 40x60  
C TKS 20x40

Typ. response behavior (TKS100x100)

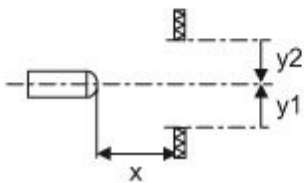
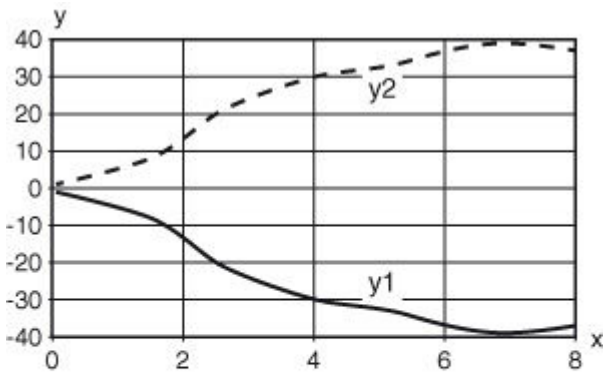



x Distance [m]  
y Misalignment [mm]

## Operation and display





### LEDs

LED	Display	Meaning
1	Yellow, continuous light	Object detected

## Reflectors & reflective tapes

	Part no.	Designation	Operating range/ Operating range limit	Description
	50117583	MTKS 50x50.1	0 ... 3.5 m 0 ... 4 m	Design: Rectangular Reflective surface: 50 mm x 50 mm Triple reflector size: 1.2 mm Material: Plastic Base material: Plastic Chemical designation of the material: PMMA8N Fastening: Through-hole mounting, Adhesive
	50110192	REF 6-A-50x50	0 ... 2.5 m 0 ... 3 m	Design: Rectangular Reflective surface: 50 mm x 50 mm Triple reflector size: 0.3 mm Material: Plastic Chemical designation of the material: PMMA Fastening: Self-adhesive

**Part no.: 50134379 – PRK15.D1/4 – Polarized retro-reflective photoelectric**

	Part no.	Designation	Operating range/ Operating range limit	Description
	50003192	TK 100x100	0 ... 6 m 0 ... 8 m	Design: Rectangular Reflective surface: 96 mm x 96 mm Triple reflector size: 4 mm Material: Plastic Base material: Plastic Chemical designation of the material: PMMA8N Fastening: Adhesive
	50022816	TKS 100X100	0 ... 6 m 0 ... 8 m	Design: Rectangular Reflective surface: 96 mm x 96 mm Triple reflector size: 4 mm Material: Plastic Base material: Plastic Chemical designation of the material: PMMA8N Fastening: Through-hole mounting, Adhesive
	50081283	TKS 20X40	0 ... 2 m 0 ... 3 m	Design: Rectangular Reflective surface: 16 mm x 38 mm Triple reflector size: 2.3 mm Material: Plastic Base material: Plastic Chemical designation of the material: PMMA8N Fastening: Through-hole mounting, Adhesive
	50040820	TKS 40X60	0 ... 3 m 0 ... 4 m	Design: Rectangular Reflective surface: 37 mm x 56 mm Triple reflector size: 4 mm Material: Plastic Base material: Plastic Chemical designation of the material: PMMA8N Fastening: Through-hole mounting, Adhesive

## Part number code

Part designation: **AAA15d.EE/ ff-HH**

AAA15	<b>Operating principle / construction:</b> HT15: diffuse reflection sensor with background suppression PRK15: retro-reflective photoelectric sensor with polarization filter LS15: throughbeam photoelectric sensor transmitter LE15: throughbeam photoelectric sensor receiver
d	<b>Light type:</b> n/a: red light l: infrared light
EE	<b>Equipment:</b> 1: adjustable range D: detection of stretch-wrapped objects
ff	<b>Switching output / function / OUT1OUT2 (OUT1 = pin 4, OUT2 = pin 2):</b> 2: NPN transistor output, light switching N: NPN transistor output, dark switching 4: PNP transistor output, light switching P: PNP transistor output, dark switching X: not connected (n. c.)
HH	<b>Electrical connection:</b> n/a: cable, PVC, standard length 2000 mm, 4-wire M8: M8 connector, 4-pin (plug) 200-M12: cable, PVC, length 200 mm with M12 connector, 4-pin, axial (plug) M12: M12 connector, 4-pin (plug)

### Note

A list with all available device types can be found on the Leuze electronic website at [www.leuze.com](http://www.leuze.com).

## Notes

### Observe intended use!

- This product is not a safety sensor and is not intended as personnel protection.
- The product may only be put into operation by competent persons.
- Only use the product in accordance with its intended use.



### For UL applications:

- Only for use in "class 2" circuits
- These proximity switches shall be used with UL Listed Cable assemblies rated 30V, 0.5A min, in the field installation, or equivalent (categories: CYJV/CYJV7 or PVVA/PVVA7)



- Light source: Average life expectancy 100,000 h at an ambient temperature of 25 °C

## Accessories





### Mounting technology - Mounting brackets

	Part no.	Designation	Article	Description
	50124651	BT 205M-10SET	Mounting device set	Contains: 10x Design of mounting device: Angle, L-shape Fastening, at system: Through-hole mounting Mounting bracket, at device: Screw type Type of mounting device: Rigid Material: Metal
	50040269	BT 25	Mounting device	Design of mounting device: Angle, L-shape Fastening, at system: Through-hole mounting Mounting bracket, at device: Screw type Type of mounting device: Rigid Material: Metal





### Mounting technology - Rod mounts

	Part no.	Designation	Article	Description
	50117830	BTP 200M-D10	Mounting system	Design of mounting device: Protection hood Fastening, at system: For 10 mm rod Mounting bracket, at device: Screw type Type of mounting device: Clampable, Adjustable, Turning, 360° Material: Metal
	50117829	BTP 200M-D12	Mounting system	Design of mounting device: Protection hood Fastening, at system: For 12 mm rod Mounting bracket, at device: Screw type Type of mounting device: Clampable, Adjustable, Turning, 360° Material: Metal

**Part no.: 50134379 – PRK15.D1/4 – Polarized retro-reflective photoelectric**

	Part no.	Designation	Article	Description
	50117828	BTP 200M-D14	Mounting system	Design of mounting device: Protection hood Fastening, at system: For 14 mm rod Mounting bracket, at device: Screw type Type of mounting device: Clampable, Adjustable, Turning, 360° Material: Metal
	50117256	BTU 200M-D10	Mounting system	Contains: 2x M3 x 18 screw, 2x position washers Design of mounting device: Mounting system Fastening, at system: For 10 mm rod, Sheet-metal mounting Mounting bracket, at device: Screw type Type of mounting device: Clampable, Adjustable, Turning, 360° Material: Metal
	50117255	BTU 200M-D12	Mounting system	Contains: 2x M3 x 18 screw, 2x position washers Design of mounting device: Mounting system Fastening, at system: For 12 mm rod, Sheet-metal mounting Mounting bracket, at device: Screw type Type of mounting device: Clampable, Adjustable, Turning, 360° Material: Metal
	50117254	BTU 200M-D14	Mounting system	Contains: 2x M3 x 18 screw, 2x position washers Design of mounting device: Mounting system Fastening, at system: For 14 mm rod, Sheet-metal mounting Mounting bracket, at device: Screw type Type of mounting device: Clampable, Adjustable, Turning, 360° Material: Metal
	50122797	BTU 346M-D12	Mounting system	Contains: 2x M4 x 25 screw, 2x position washers Design of mounting device: Mounting system Fastening, at system: For 12 mm rod, Sheet-metal mounting Mounting bracket, at device: Screw type Type of mounting device: Turning, 360°, Clampable, Adjustable Material: Metal

**Standard reflectors**



	Part no.	Designation	Article	Description
	50003192	TK 100x100	Reflector	Design: Rectangular Reflective surface: 96 mm x 96 mm Triple reflector size: 4 mm Material: Plastic Base material: Plastic Chemical designation of the material: PMMA8N Fastening: Adhesive
	50022816	TKS 100X100	Reflector	Design: Rectangular Reflective surface: 96 mm x 96 mm Triple reflector size: 4 mm Material: Plastic Base material: Plastic Chemical designation of the material: PMMA8N Fastening: Through-hole mounting, Adhesive
	50081283	TKS 20X40	Reflector	Design: Rectangular Reflective surface: 16 mm x 38 mm Triple reflector size: 2.3 mm Material: Plastic Base material: Plastic Chemical designation of the material: PMMA8N Fastening: Through-hole mounting, Adhesive
	50040820	TKS 40X60	Reflector	Design: Rectangular Reflective surface: 37 mm x 56 mm Triple reflector size: 4 mm Material: Plastic Base material: Plastic Chemical designation of the material: PMMA8N Fastening: Through-hole mounting, Adhesive

Part no.: 50134379 – PRK15.D1/4 – Polarized retro-reflective photoelectric

### Micro-triad-type reflectors

	Part no.	Designation	Article	Description
	50117583	MTKS 50x50.1	Reflector	Design: Rectangular Reflective surface: 50 mm x 50 mm Triple reflector size: 1.2 mm Material: Plastic Base material: Plastic Chemical designation of the material: PMMA8N Fastening: Through-hole mounting, Adhesive

### Reflective tapes for standard applications

	Part no.	Designation	Article	Description
	50108300	REF 4-A-50x50	Reflective tape	Design: Rectangular Reflective surface: 50 mm x 50 mm Material: Plastic Chemical designation of the material: PMMA Fastening: Self-adhesive
	50110192	REF 6-A-50x50	Reflective tape	Design: Rectangular Reflective surface: 50 mm x 50 mm Triple reflector size: 0.3 mm Material: Plastic Chemical designation of the material: PMMA Fastening: Self-adhesive