



Figure can vary

Part no.: 50134287
PRK25C.D/4P-M12
Polarized retro-reflective photoelectric
sensor



Contents

- Technical data
- Dimensioned drawings
- Electrical connection
- Diagrams
- Operation and display
- Reflectors & reflective tapes
- Part number code
- Notes
- Accessories

Technical data

Basic data	
Series	25C
Operating principle	Reflection principle
Application	Detection of stretch-wrapped objects

Optical data	
Operating range	Guaranteed operating range
Operating range	0.05 ... 8 m, With reflector TK(S) 100x100
Operating range limit	Typical operating range
Operating range limit	0.05 ... 10 m, With reflector TK(S) 100x100
Light source	LED, Red
LED light wavelength	640 nm
Transmitted-signal shape	Pulsed
LED group	Exempt group (in acc. with EN 62471)

Electrical data	
Protective circuit	Polarity reversal protection Short circuit protected

Performance data	
Supply voltage U_B	10 ... 30 V, DC, Incl. residual ripple
Residual ripple	0 ... 15 %, From U_B
Open-circuit current	0 ... 20 mA

Outputs	
Number of digital switching outputs	2 Piece(s)

Switching outputs	
Voltage type	DC
Switching current, max.	100 mA
Switching voltage	high: $\geq(U_B - 2.5V)$ low: $\leq 2.5V$

Switching output 1	
Assignment	Connection 1, pin 4
Switching element	Transistor, PNP
Switching principle	Light switching

Switching output 2	
Assignment	Connection 1, pin 2
Switching element	Transistor, PNP
Switching principle	Dark switching

Timing	
Switching frequency	1,500 Hz
Response time	0.33 ms
Readiness delay	300 ms

Connection	
-------------------	--

Part no.: 50134287 – PRK25C.D/4P-M12 – Polarized retro-reflective

Connection 1

Type of connection	Connector
Function	Signal OUT Voltage supply
Thread size	M12
Type	Male
Material	PUR
No. of pins	4 -pin
Encoding	A-coded

Mechanical data

Dimension (W x H x L)	15 mm x 42.7 mm x 30 mm
Housing material	Plastic, ABS
Lens cover material	Plastic
Net weight	22 g
Housing color	Red
Type of fastening	Through-hole mounting with M4 thread Via optional mounting device
Compatibility of materials	ECOLAB

Operation and display

Type of display	LED
Number of LEDs	2 Piece(s)

Environmental data

Ambient temperature, operation	-40 ... 60 °C
Ambient temperature, storage	-40 ... 70 °C

Certifications

Degree of protection	IP 67 IP 69K
Protection class	III
Certifications	c UL US
Standards applied	IEC 60947-5-2

Classification

Customs tariff number	85365019
eCl@ss 8.0	27270902
eCl@ss 9.0	27270902
ETIM 5.0	EC002717
ETIM 6.0	EC002717

Dimensioned drawings

All dimensions in millimeters

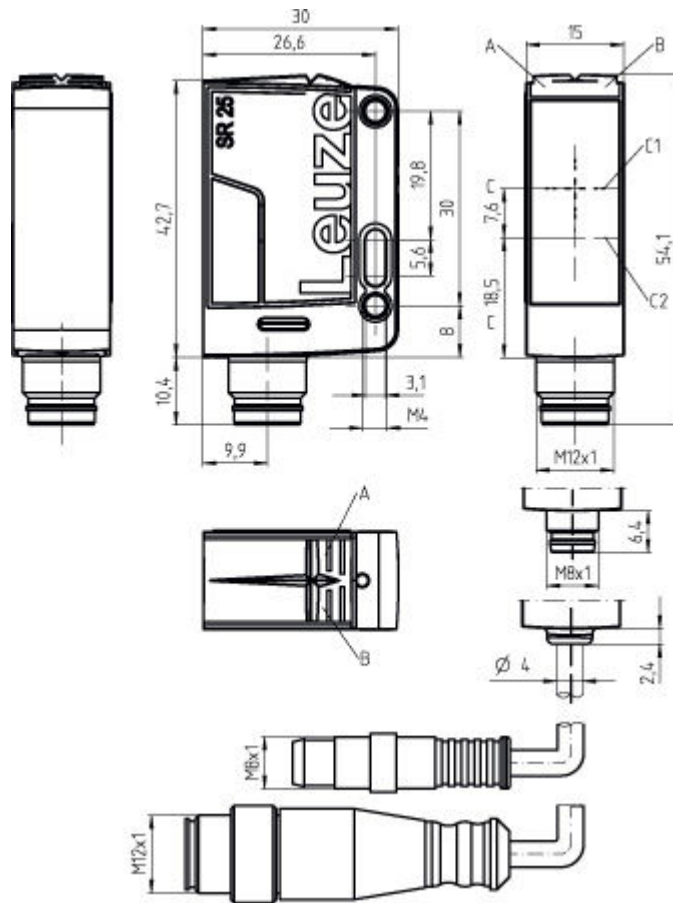

- A Green LED
- B Yellow LED
- C Optical axis
- C1 Receiver
- C2 Transmitter

Electrical connection

Connection 1	
Type of connection	Connector
Function	Signal OUT Voltage supply
Thread size	M12
Type	Male
Material	PUR
No. of pins	4 -pin
Encoding	A-coded

Pin	Pin assignment
1	V+
2	OUT 2
3	GND
4	OUT 1

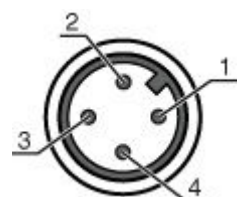

Diagrams

Typ. response behavior (TKS100x100)

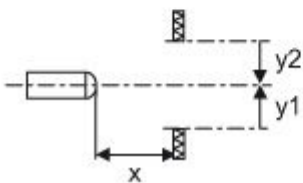
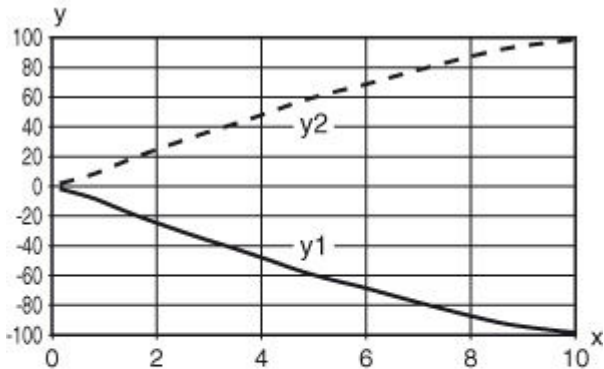

x Distance [m]
y Misalignment [mm]

Typ. function reserve

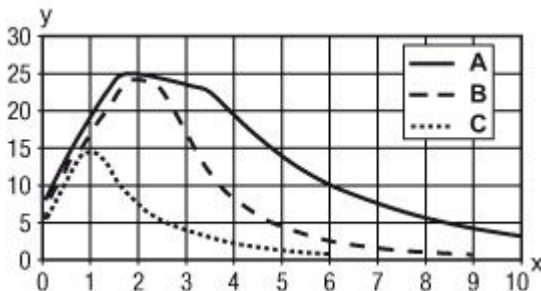

x Distance [m]
y Function reserve
A TKS 100x100
B TKS 40x60
C TKS 20x40

Operation and display

LEDs

LED	Display	Meaning
1	Green, continuous light	Operational readiness
2	Yellow, continuous light	Light path free
	Yellow, flashing	Light path free, no function reserve

Reflectors & reflective tapes

	Part no.	Designation	Operating range/ Operating range limit	Description
	50117583	MTKS 50x50.1	0.05 ... 5 m 0.05 ... 6 m	Design: Rectangular Reflective surface: 50 mm x 50 mm Triple reflector size: 1.2 mm Material: Plastic Base material: Plastic Chemical designation of the material: PMMA8N Fastening: Through-hole mounting, Adhesive
	50106119	REF 4-A-100x100	0.05 ... 2 m 0.05 ... 2.5 m	Design: Rectangular Reflective surface: 100 mm x 100 mm Material: Plastic Chemical designation of the material: PMMA Fastening: Self-adhesive
	50110192	REF 6-A-50x50	0.05 ... 3.5 m 0.05 ... 4 m	Design: Rectangular Reflective surface: 50 mm x 50 mm Triple reflector size: 0.3 mm Material: Plastic Chemical designation of the material: PMMA Fastening: Self-adhesive
	50003192	TK 100x100	0.05 ... 8 m 0.05 ... 10 m	Design: Rectangular Reflective surface: 96 mm x 96 mm Triple reflector size: 4 mm Material: Plastic Base material: Plastic Chemical designation of the material: PMMA8N Fastening: Adhesive
	50022816	TKS 100X100	0.05 ... 8 m 0.05 ... 10 m	Design: Rectangular Reflective surface: 96 mm x 96 mm Triple reflector size: 4 mm Material: Plastic Base material: Plastic Chemical designation of the material: PMMA8N Fastening: Through-hole mounting, Adhesive
	50081283	TKS 20X40	0.05 ... 2.5 m 0.05 ... 3 m	Design: Rectangular Reflective surface: 16 mm x 38 mm Triple reflector size: 2.3 mm Material: Plastic Base material: Plastic Chemical designation of the material: PMMA8N Fastening: Through-hole mounting, Adhesive
	50040820	TKS 40X60	0.05 ... 4 m 0.05 ... 5 m	Design: Rectangular Reflective surface: 37 mm x 56 mm Triple reflector size: 4 mm Material: Plastic Base material: Plastic Chemical designation of the material: PMMA8N Fastening: Through-hole mounting, Adhesive

Part number code

Part designation: AAA25C d EE-f.GGH/IJ-K

AAA25C	Operating principle / construction: HT25C: diffuse reflection sensor with background suppression PRK25C: retro-reflective photoelectric sensor with polarization filter LS25C: throughbeam photoelectric sensor transmitter LE25C: throughbeam photoelectric sensor receiver
--------	---

Part no.: 50134287 – PRK25C.D/4P-M12 – Polarized retro-reflective

d	Light type: n/a: red light l: infrared light
EE	Light source: n/a: LED L1: laser class 1 L2: laser class 2
f	Pre-set range (optional): n/a: operating range acc. to data sheet XXXX: pre-set range [mm]
GG	Equipment: A: autocollimation principle (single lens) S: small light spot D: detection of stretch-wrapped objects X: extended model HF: suppression of HF illumination (LED) XL: extra long light spot T: autocollimation principle (single lens) for highly transparent bottles without tracking TT: autocollimation principle (single lens) for highly transparent bottles with tracking
H	Operating range adjustment: 1: 270° potentiometer 2: multiturn potentiometer 3: teach-in via button
i	Switching output/function OUT 1/IN: Pin 4 or black conductor: 2: NPN transistor output, light switching N: NPN transistor output, dark switching 4: PNP transistor output, light switching P: PNP transistor output, dark switching X: pin not used 8: activation input (activation with high signal)
J	Switching output / function OUT 2/IN: pin 2 or white conductor: 2: NPN transistor output, light switching N: NPN transistor output, dark switching 4: PNP transistor output, light switching P: PNP transistor output, dark switching W: warning output X: pin not used
K	Electrical connection: n/a: cable, PVC, standard length 2000 mm, 4-wire 200-M12: cable, PVC, length 200 mm with M12 connector, 4-pin, axial (plug) M8: M8 connector, 4-pin (plug) M12: M12 connector, 4-pin (plug) 200-M8: cable, PVC, length 200 mm with M8 connector, 4-pin, axial (plug)

Note

A list with all available device types can be found on the Leuze electronic website at www.leuze.com.

Notes

Observe intended use!

- This product is not a safety sensor and is not intended as personnel protection.
- The product may only be put into operation by competent persons.
- Only use the product in accordance with its intended use.

For UL applications:



- Only for use in "class 2" circuits
- These proximity switches shall be used with UL Listed Cable assemblies rated 30V, 0.5A min, in the field installation, or equivalent (categories: CYJV/CYJV7 or PVVA/PVVA7)

Part no.: 50134287 – PRK25C.D/4P-M12 – Polarized retro-reflective



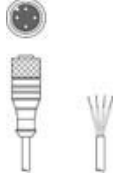

- Light source: Average life expectancy 100,000 h at an ambient temperature of 25 °C
- Sum of the output currents for both outputs 100 mA

Accessories

Connection technology - Connection cables

	Part no.	Designation	Article	Description
	50130654	KD U-M12-4A-P1-020	Connection cable	Connection 1: Connector, M12, Axial, Female, A-coded, 4 -pin Connection 2: Open end Shielded: No Cable length: 2,000 mm Sheathing material: PUR
	50130657	KD U-M12-4A-P1-050	Connection cable	Connection 1: Connector, M12, Axial, Female, A-coded, 4 -pin Connection 2: Open end Shielded: No Cable length: 5,000 mm Sheathing material: PUR
	50130658	KD U-M12-4A-P1-100	Connection cable	Connection 1: Connector, M12, Axial, Female, A-coded, 4 -pin Connection 2: Open end Shielded: No Cable length: 10,000 mm Sheathing material: PUR
	50130648	KD U-M12-4A-V1-020	Connection cable	Connection 1: Connector, M12, Axial, Female, A-coded, 4 -pin Connection 2: Open end Shielded: No Cable length: 2,000 mm Sheathing material: PVC
	50130652	KD U-M12-4A-V1-050	Connection cable	Connection 1: Connector, M12, Axial, Female, A-coded, 4 -pin Connection 2: Open end Shielded: No Cable length: 5,000 mm Sheathing material: PVC
	50130653	KD U-M12-4A-V1-100	Connection cable	Connection 1: Connector, M12, Axial, Female, A-coded, 4 -pin Connection 2: Open end Shielded: No Cable length: 10,000 mm Sheathing material: PVC
	50130692	KD U-M12-4W-P1-020	Connection cable	Connection 1: Connector, M12, Angled, Female, A-coded, 4 -pin Connection 2: Open end Shielded: No Cable length: 2,000 mm Sheathing material: PUR
	50130694	KD U-M12-4W-P1-050	Connection cable	Connection 1: Connector, M12, Angled, Female, A-coded, 4 -pin Connection 2: Open end Shielded: No Cable length: 5,000 mm Sheathing material: PUR



Part no.: 50134287 – PRK25C.D/4P-M12 – Polarized retro-reflective

	Part no.	Designation	Article	Description
	50130695	KD U-M12-4W-P1-100	Connection cable	Connection 1: Connector, M12, Angled, Female, A-coded, 4 -pin Connection 2: Open end Shielded: No Cable length: 10,000 mm Sheathing material: PUR
	50130688	KD U-M12-4W-V1-020	Connection cable	Connection 1: Connector, M12, Angled, Female, A-coded, 4 -pin Connection 2: Open end Shielded: No Cable length: 2,000 mm Sheathing material: PVC
	50130690	KD U-M12-4W-V1-050	Connection cable	Connection 1: Connector, M12, Angled, Female, A-coded, 4 -pin Connection 2: Open end Shielded: No Cable length: 5,000 mm Sheathing material: PVC
	50130691	KD U-M12-4W-V1-100	Connection cable	Connection 1: Connector, M12, Angled, Female, A-coded, 4 -pin Connection 2: Open end Shielded: No Cable length: 10,000 mm Sheathing material: PVC

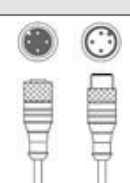
Connection technology - Interconnection cables

	Part no.	Designation	Article	Description
	50130738	KDS U-M12-4A-M12-4A-P1-006	Interconnection cable	Connection 1: Connector, M12, Axial, Female, A-coded, 4 -pin Connection 2: Connector, M12, Axial, Male, A-coded, 4 -pin Shielded: No Cable length: 600 mm Sheathing material: PUR

Mounting technology - Mounting brackets

	Part no.	Designation	Article	Description
	50124651	BT 205M-10SET	Mounting device set	Contains: 10x Design of mounting device: Angle, L-shape Fastening, at system: Through-hole mounting Mounting bracket, at device: Screw type Type of mounting device: Rigid Material: Metal
	50118543	BT 300M.5	Mounting bracket	Design of mounting device: Angle, L-shape Fastening, at system: Through-hole mounting Mounting bracket, at device: Screw type Type of mounting device: Adjustable Material: Stainless steel





Part no.: 50134287 – PRK25C.D/4P-M12 – Polarized retro-reflective

Mounting technology - Rod mounts

	Part no.	Designation	Article	Description
	50117830	BTP 200M-D10	Mounting system	Design of mounting device: Protection hood Fastening, at system: For 10 mm rod Mounting bracket, at device: Screw type Type of mounting device: Clampable, Adjustable, Turning, 360° Material: Metal
	50117829	BTP 200M-D12	Mounting system	Design of mounting device: Protection hood Fastening, at system: For 12 mm rod Mounting bracket, at device: Screw type Type of mounting device: Clampable, Adjustable, Turning, 360° Material: Metal
	50117828	BTP 200M-D14	Mounting system	Design of mounting device: Protection hood Fastening, at system: For 14 mm rod Mounting bracket, at device: Screw type Type of mounting device: Clampable, Adjustable, Turning, 360° Material: Metal
	50117256	BTU 200M-D10	Mounting system	Contains: 2x M3 x 18 screw, 2x position washers Design of mounting device: Mounting system Fastening, at system: For 10 mm rod, Sheet-metal mounting Mounting bracket, at device: Screw type Type of mounting device: Clampable, Adjustable, Turning, 360° Material: Metal
	50117255	BTU 200M-D12	Mounting system	Contains: 2x M3 x 18 screw, 2x position washers Design of mounting device: Mounting system Fastening, at system: For 12 mm rod, Sheet-metal mounting Mounting bracket, at device: Screw type Type of mounting device: Clampable, Adjustable, Turning, 360° Material: Metal
	50117254	BTU 200M-D14	Mounting system	Contains: 2x M3 x 18 screw, 2x position washers Design of mounting device: Mounting system Fastening, at system: For 14 mm rod, Sheet-metal mounting Mounting bracket, at device: Screw type Type of mounting device: Clampable, Adjustable, Turning, 360° Material: Metal
	50117252	BTU 300M-D12	Mounting system	Contains: 2x M4 x 25 screw, 2x M4 x 20 screw, 4x position washers Design of mounting device: Mounting system Fastening, at system: For 12 mm rod, Sheet-metal mounting Mounting bracket, at device: Screw type Type of mounting device: Clampable, Adjustable, Turning, 360° Material: Metal
	50122797	BTU 346M-D12	Mounting system	Contains: 2x M4 x 25 screw, 2x position washers Design of mounting device: Mounting system Fastening, at system: For 12 mm rod, Sheet-metal mounting Mounting bracket, at device: Screw type Type of mounting device: Turning, 360°, Clampable, Adjustable Material: Metal

Part no.: 50134287 – PRK25C.D/4P-M12 – Polarized retro-reflective

Standard reflectors

	Part no.	Designation	Article	Description
	50108300	REF 4-A-50x50	Reflective tape	Design: Rectangular Reflective surface: 50 mm x 50 mm Material: Plastic Chemical designation of the material: PMMA Fastening: Self-adhesive
	50003192	TK 100x100	Reflector	Design: Rectangular Reflective surface: 96 mm x 96 mm Triple reflector size: 4 mm Material: Plastic Base material: Plastic Chemical designation of the material: PMMA8N Fastening: Adhesive
	50022816	TKS 100X100	Reflector	Design: Rectangular Reflective surface: 96 mm x 96 mm Triple reflector size: 4 mm Material: Plastic Base material: Plastic Chemical designation of the material: PMMA8N Fastening: Through-hole mounting, Adhesive
	50081283	TKS 20X40	Reflector	Design: Rectangular Reflective surface: 16 mm x 38 mm Triple reflector size: 2.3 mm Material: Plastic Base material: Plastic Chemical designation of the material: PMMA8N Fastening: Through-hole mounting, Adhesive
	50040820	TKS 40X60	Reflector	Design: Rectangular Reflective surface: 37 mm x 56 mm Triple reflector size: 4 mm Material: Plastic Base material: Plastic Chemical designation of the material: PMMA8N Fastening: Through-hole mounting, Adhesive

Micro-triad-type reflectors

	Part no.	Designation	Article	Description
	50117583	MTKS 50x50.1	Reflector	Design: Rectangular Reflective surface: 50 mm x 50 mm Triple reflector size: 1.2 mm Material: Plastic Base material: Plastic Chemical designation of the material: PMMA8N Fastening: Through-hole mounting, Adhesive

Reflective tapes for standard applications

	Part no.	Designation	Article	Description
	50106119	REF 4-A-100x100	Reflective tape	Design: Rectangular Reflective surface: 100 mm x 100 mm Material: Plastic Chemical designation of the material: PMMA Fastening: Self-adhesive

Part no.: 50134287 – PRK25C.D/4P-M12 – Polarized retro-reflective

	Part no.	Designation	Article	Description
	50110192	REF 6-A-50x50	Reflective tape	Design: Rectangular Reflective surface: 50 mm x 50 mm Triple reflector size: 0.3 mm Material: Plastic Chemical designation of the material: PMMA Fastening: Self-adhesive