



Figure can vary

**Part no.: 50133620**  
**HT3CL2.B/4P-200-M12**  
**Diffuse sensor with background suppression**



## Contents

- Technical data
- Dimensioned drawings
- Electrical connection
- Diagrams
- Operation and display
- Part number code
- Notes
- Accessories

## Technical data

| <b>Basic data</b>                    |   |
|--------------------------------------|---|
| Series                               | 3C  |
| Operating principle                  | Diffuse reflection principle with background suppression                          |
| <b>Optical data</b>                  |   |
| Black-white error                    | < 10% up to 250 mm  |
| Operating range                      | Guaranteed operating range  |
| Operating range, white 90%           | 0.015 ... 0.55 m  |
| Operating range, gray 18%            | 0.015 ... 0.44 m  |
| Operating range, black 6%            | 0.015 ... 0.25 m  |
| Operating range limit                | Typical operating range   |
| Operating range limit                | 0.015 ... 0.55 m  |
| Adjustment range                     | 20 ... 550 mm   |
| Beam profile                         | Collimated  |
| Light source                         | Laser , Red   |
| Laser light wavelength               | 650 nm  |
| Laser class                          | 2 , IEC/EN 60825-1:2007   |
| Max. laser power                     | 0.0045 W  |
| Transmitted-signal shape             | Pulsed  |
| Pulse duration                       | 5.1 $\mu$ s   |
| Light-spot size [at sensor distance] | 1 mm [550 mm]   |
| Type of light-spot geometry          | Round   |
| Shift angle                          | Typ. $\pm$ 2°   |
| <b>Electrical data</b>               |   |
| Protective circuit                   | Overvoltage protection<br>Polarity reversal protection<br>Short circuit protected |
| <b>Performance data</b>              |   |
| Supply voltage $U_B$                 | 10 ... 30 V , DC , Incl. residual ripple  |
| Residual ripple                      | 0 ... 10 % , From $U_B$   |
| Open-circuit current                 | 0 ... 20 mA   |
| <b>Outputs</b>                       |   |
| Number of digital switching outputs  | 2 Piece(s)  |
| <b>Switching outputs</b>             |   |
| Voltage type                         | DC  |
| Switching current, max.              | 100 mA  |
| Switching voltage                    | High: $\geq(U_B-2V)$<br>Low: $\leq 2V$  |
| <b>Switching output 1</b>            |   |
| Assignment                           | Connection 1, pin 4   |
| Switching element                    | Transistor , PNP  |
| Switching principle                  | Light switching   |
| <b>Switching output 2</b>            |   |
| Assignment                           | Connection 1, pin 2   |
| Switching element                    | Transistor , PNP  |
| Switching principle                  | Dark switching  |
| <b>Timing</b>                        |   |

**Part no.: 50133620 – HT3CL2.B/4P-200-M12 – Diffuse sensor with background**

|                     |          |
|---------------------|----------|
| Switching frequency | 3,000 Hz |
| Response time       | 0.16 ms  |
| Decay time          | 0.16 ms  |
| Readiness delay     | 300 ms   |
| Response jitter     | 55 µs    |

**Connection**
**Connection 1**

|                    |                              |
|--------------------|------------------------------|
| Type of connection | Cable with connector         |
| Function           | Signal OUT<br>Voltage supply |
| Cable length       | 200 mm                       |
| Sheathing material | PUR                          |
| Cable color        | Black                        |
| Wire cross section | 0.2 mm <sup>2</sup>          |
| Thread size        | M12                          |
| Type               | Male                         |
| Material           | Metal                        |
| No. of pins        | 4 -pin                       |
| Encoding           | A-coded                      |

**Mechanical data**

|                            |   |
|----------------------------|---|
| Dimension (W x H x L)      | 11.4 mm x 34.2 mm x 18.3 mm                             |
| Housing material           | Plastic , PC-ABS  |
| Lens cover material        | Plastic / PMMA  |
| Net weight                 | 20 g  |
| Housing color              | Red   |
| Type of fastening          | Two M3 threaded sleeves<br>Via optional mounting device |
| Compatibility of materials | ECOLAB  |

**Operation and display**

|                                     |                         |
|-------------------------------------|-------------------------|
| Type of display                     | LED                     |
| Number of LEDs                      | 2 Piece(s)              |
| Operational controls                | Multiturn potentiometer |
| Function of the operational control | Range adjustment        |

**Environmental data**

|                                |               |
|--------------------------------|---------------|
| Ambient temperature, operation | -40 ... 55 °C |
| Ambient temperature, storage   | -40 ... 70 °C |

**Certifications**

|                      |                 |
|----------------------|-----------------|
| Degree of protection | IP 67<br>IP 69K |
| Protection class     | III             |
| Certifications       | c UL US         |
| Standards applied    | IEC 60947-5-2   |

**Classification**

|                       |          |
|-----------------------|----------|
| Customs tariff number | 85365019 |
|-----------------------|----------|

|            |          |
|------------|----------|
| eCl@ss 8.0 | 27270904 |
| eCl@ss 9.0 | 27270904 |
| ETIM 5.0   | EC002719 |
| ETIM 6.0   | EC002719 |

## Dimensioned drawings

All dimensions in millimeters

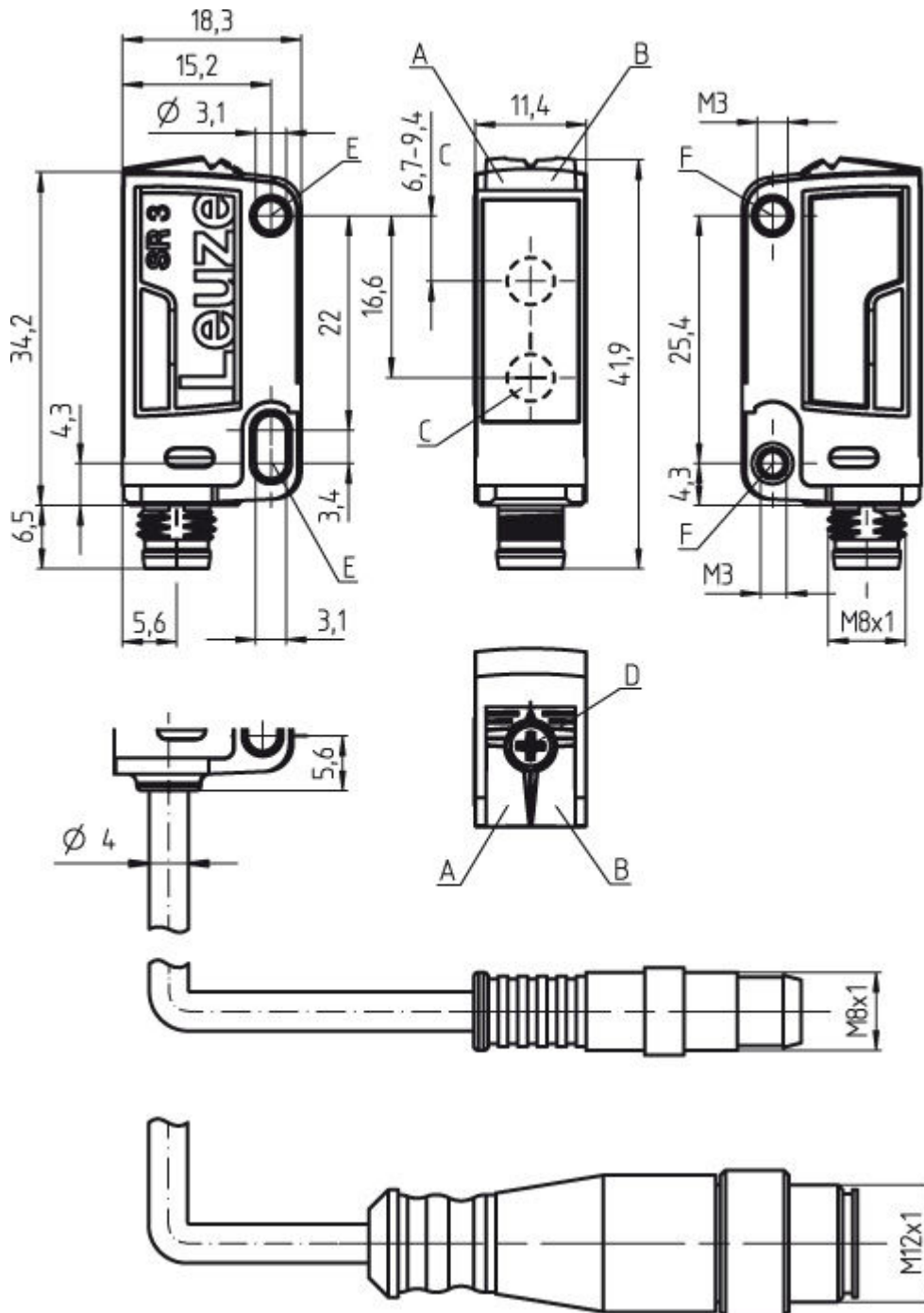

A Green LED  
B Yellow LED

- C Optical axis
- D Multiturn potentiometer
- E Mounting sleeve (standard)
- F Threaded sleeve (3C.B series)

## Electrical connection

| Connection 1       |                              |
|--------------------|------------------------------|
| Type of connection | Cable with connector         |
| Function           | Signal OUT<br>Voltage supply |
| Cable length       | 200 mm                       |
| Sheathing material | PUR                          |
| Cable color        | Black                        |
| Wire cross section | 0.2 mm <sup>2</sup>          |
| Thread size        | M12                          |
| Type               | Male                         |
| Material           | Metal                        |
| No. of pins        | 4 -pin                       |
| Encoding           | A-coded                      |

| Pin | Pin assignment |
|-----|----------------|
| 1   | V+             |
| 2   | OUT 2          |
| 3   | GND            |
| 4   | OUT 1          |

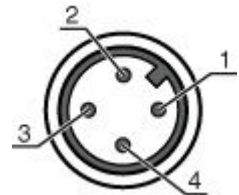

## Diagrams

Typ. black/white behavior

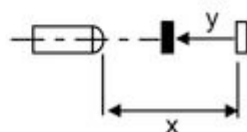
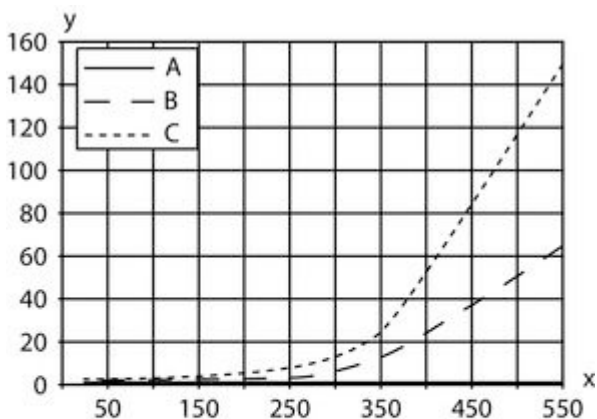

x Distance [mm]

|   |                         |
|---|-------------------------|
| y | Reduction of range [mm] |
| A | White 90%               |
| B | Gray 18%                |
| C | Black 6%                |

## Operation and display

### LEDs

| LED | Display                  | Meaning               |
|-----|--------------------------|-----------------------|
| 1   | Green, continuous light  | Operational readiness |
| 2   | Yellow, continuous light | Object detected       |

## Part number code

Part designation: **AAA 3C d EE-f.GG H/i J-K**

|       |   |
|-------|---|
| AAA3C | <b>Operating principle / construction:</b><br>HT3C: diffuse reflection sensor with background suppression<br>LS3C: throughbeam photoelectric sensor transmitter<br>LE3C: throughbeam photoelectric sensor receiver<br>PRK3C: retro-reflective photoelectric sensor with polarization filter   |
| d     | <b>Light type:</b><br>n/a: red light<br>l: infrared light   |
| EE    | <b>Light source:</b><br>n/a: LED<br>L1: laser class 1<br>L2: laser class 2  |
| f     | <b>Pre-set range (optional):</b><br>n/a: operating range acc. to data sheet<br>XXXX: pre-set range [mm]   |
| GG    | <b>Equipment:</b><br>n/a: standard<br>A: autocollimation principle (single lens) for positioning tasks<br>B: housing model with two M3 threaded sleeves, brass<br>F: permanently set range<br>L: long light spot<br>S: small light spot<br>T: autocollimation principle (single lens) for highly transparent bottles without tracking<br>TT: autocollimation principle (single lens) for highly transparent bottles with tracking<br>V: V-optics<br>XL: extra long light spot                     |
| H     | <b>Operating range adjustment:</b><br>n/a with HT: range adjustable via 8-turn potentiometer<br>n/a with retro-reflective photoelectric sensors (PRK): operating range not adjustable<br>1: 270° potentiometer<br>3: teach-in via button<br>6: auto-teach   |
| i     | <b>Switching output/function OUT 1/IN: Pin 4 or black conductor:</b><br>2: NPN transistor output, light switching<br>N: NPN transistor output, dark switching<br>4: PNP transistor output, light switching<br>P: PNP transistor output, dark switching<br>6: push-pull switching output, PNP light switching, NPN dark switching<br>G: push-pull switching output, PNP dark switching, NPN light switching<br>/L: IO-Link<br>8: activation input (activation with high signal)<br>X: pin not used |

|   |   |
|---|---|
| J | <b>Switching output / function OUT 2/IN: pin 2 or white conductor:</b><br>2: NPN transistor output, light switching<br>N: NPN transistor output, dark switching<br>4: PNP transistor output, light switching<br>P: PNP transistor output, dark switching<br>6: push-pull switching output, PNP light switching, NPN dark switching<br>G: push-pull switching output, PNP dark switching, NPN light switching<br>W: warning output<br>X: pin not used<br>8: activation input (activation with high signal)<br>9: deactivation input (deactivation with high signal)<br>T: teach-in via cable |
| K | <b>Electrical connection:</b><br>n/a: cable, standard length 2000 mm, 4-wire<br>5000: cable, standard length 5000 mm, 4-wire<br>M8: M8 connector, 4-pin (plug)<br>M8.3: M8 connector, 3-pin (plug)<br>200-M8: cable, length 200 mm with M8 connector, 4-pin, axial (plug)<br>200-M8.3: cable, length 200 mm with M8 connector, 3-pin, axial (plug)<br>200-M12: cable, length 200 mm with M12 connector, 4-pin, axial (plug)   |

#### Note

A list with all available device types can be found on the Leuze electronic website at [www.leuze.com](http://www.leuze.com).

## Notes

#### Observe intended use!

- This product is not a safety sensor and is not intended as personnel protection.
- The product may only be put into operation by competent persons.
- Only use the product in accordance with its intended use.

#### For UL applications:

- For UL applications, use is only permitted in Class 2 circuits in accordance with the NEC (National Electric Code).
- These proximity switches shall be used with UL Listed Cable assemblies rated 30V, 0.5A min, in the field installation, or equivalent (categories: CYJV/CYJV7 or PVVA/PVVA7)

#### WARNING! LASER RADIATION – LASER CLASS 2

##### Never look directly into the beam!

The device satisfies the requirements of IEC 60825-1:2007 (EN 60825-1:2007) safety regulations for a product of **laser class 2** as well as the U.S. 21 CFR 1040.10 regulations with deviations corresponding to "Laser Notice No. 50" from June 24, 2007.

- Never look directly into the laser beam or in the direction of reflected laser beams! If you look into the beam path over a longer time period, there is a risk of injury to the retina.
- Do not point the laser beam of the device at persons!
- Interrupt the laser beam using a non-transparent, non-reflective object if the laser beam is accidentally directed towards a person.
- When mounting and aligning the device, avoid reflections of the laser beam off reflective surfaces!
- CAUTION! Use of controls or adjustments or performance of procedures other than specified herein may result in hazardous light exposure.
- Observe the applicable statutory and local laser protection regulations.
- The device must not be tampered with and must not be changed in any way.  
There are no user-serviceable parts inside the device.  
Repairs must only be performed by Leuze electronic GmbH + Co. KG.

**NOTE**

**Affix laser information and warning signs!**



Laser information and warning signs are affixed to the device. In addition, self-adhesive laser information and warning signs (stick-on labels) are supplied in several languages.

- Affix the laser information sheet to the device in the language appropriate for the place of use. When using the device in the US, use the stick-on label with the "Complies with 21 CFR 1040.10" note.
- Affix the laser information and warning signs near the device if no signs are attached to the device (e.g. because the device is too small) or if the attached laser information and warning signs are concealed due to the installation position.
- Affix the laser information and warning signs so that they are legible without exposing the reader to the laser radiation of the device or other optical radiation.

- Light source: Average life expectancy 50,000 h at an ambient temperature of 25 °C
- Response time: For short decay times, an ohmic load of approx. 5 kOhm is recommended
- Sum of the output currents for both outputs, 50 mA for ambient temperatures > 40 °C

**Accessories**

Connection technology - Connection cables

|   | Part no. | Designation        | Article          | Description  |
|---|----------|--------------------|------------------|--|
|  | 50130652 | KD U-M12-4A-V1-050 | Connection cable | Connection 1: Connector, M12, Axial, Female, A-coded, 4 -pin<br>Connection 2: Open end<br>Shielded: No<br>Cable length: 5,000 mm<br>Sheathing material: PVC  |
|  | 50130690 | KD U-M12-4W-V1-050 | Connection cable | Connection 1: Connector, M12, Angled, Female, A-coded, 4 -pin<br>Connection 2: Open end<br>Shielded: No<br>Cable length: 5,000 mm<br>Sheathing material: PVC |

Mounting technology - Mounting brackets

|   | Part no. | Designation | Article         | Description  |
|---|----------|-------------|-----------------|--|
|  | 50060511 | BT 3        | Mounting device | Design of mounting device: Angle, L-shape<br>Fastening, at system: Through-hole mounting<br>Mounting bracket, at device: Screw type<br>Type of mounting device: Rigid<br>Material: Metal |

Part no.: 50133620 – HT3CL2.B/4P-200-M12 – Diffuse sensor with background

## Mounting technology - Rod mounts

|   | Part no. | Designation  | Article         | Description   |
|---|----------|--------------|-----------------|---|
|  | 50117255 | BTU 200M-D12 | Mounting system | Contains: 2x M3 x 16 screw, 2x M3 x 20 screw, 2x position washers<br>Design of mounting device: Mounting system<br>Fastening, at system: For 12 mm rod, Sheet-metal mounting<br>Mounting bracket, at device: Screw type<br>Type of mounting device: Clampable, Adjustable, Turning, 360°<br>Material: Metal |