



Part no.: 50132985
MSI 410-03
Safety control



Figure can vary

Contents

- . Technical data
- . Dimensioned drawings
- . Electrical connection
- . Circuit diagrams
- . Notes
- . Accessories

Technical data

Basic data	
Series	MSI 410
Application	Monitoring of safety functions
Number of safe I/Os	20 IN, 4 OUT
Functions	
Functions	Additional I/O extensions available (optional) Configurable safety control Configuration via MSI.designer software Removable program memory (must be ordered separately, part no. 50132996) Transfer of diagnostic data via external fieldbus modules, e.g. MSI-FB-PROFIBUS (optional) USBmini interface
Characteristic parameters	
SIL	3 , IEC 61508
SILCL	3 , IEC/EN 62061
Performance Level (PL)	Up to and including e , EN ISO 13849-1
PFH _D	0.0000000043 per hour
PFH _D	4,3E-09 per hour
Mission time T _M	20 years , EN ISO 13849-1
Category	4 , EN ISO 13849
Electrical data	
Performance data	
Supply voltage U _B	24 V , DC , -30 ... 25 %
Power consumption, max.	3.3 W
Output circuit	
Number of outputs	4 Piece(s)
Max. number of integrated digital outputs	4 Piece(s)
Type of digital output	Transistor
Short circuit protection, outputs	Yes
Min. voltage permitted at the output	16.2 V
Max. voltage permitted at the output	30 V
Output current	4 A
Control circuit	
Number of inputs	20 Piece(s)
Voltage permitted at the input	30 V
Max. rated control supply voltage at DC	30 V
Min. rated control supply voltage at DC	15.6 V
Input current at signal 1	2.3 mA
Interface	
Type	Internal bus (SBUS+)
Service interface	
Type	USB
USB	
Function	Configuration via software

Part no.: 50132985 – MSI 410-03 – Safety control

Connection

Number of connections 2 Piece(s)

Connection 1

Type of connection Terminal
 Function Signal IN
 Signal OUT
 Voltage supply
 Type of terminal Spring-cage terminal
 No. of pins 31 -pin

Connection 2

Type of connection USB
 Function Configuration interface
 Connector type USB 2.0 Mini-A

Cable properties

Connection cross sections 2 x 0.2 to 1.5 mm², wire
 2 x 0.2 to 1.5 mm², wire
 2 x 0.25 to 1.5 mm², wire with wire-end sleeve (pressed in trapezium shape)

Mechanical data

Dimension (W x H x L) 45 mm x 107 mm x 121 mm
 Net weight 290 g
 Housing color Gray
 Type of fastening Snap-on mounting

Operation and display

Type of display LED indicator
 Type of configuration Software

Environmental data

Ambient temperature, operation -25 ... 65 °C
 Ambient temperature, storage -25 ... 70 °C
 Relative humidity (non-condensing) 10 ... 95 %

Certifications

Degree of protection IP 20
 Protection class III
 Certifications c UL US
 TÜV Rheinland
 Vibration resistance 5 ... 150 Hz
 Test procedure for oscillation in accordance with standard EN 60068-2-6
 Shock resistance, single shock 30 g, 11 ms, EN 60068-2-27
 Shock resistance, continuous shock 10 g, 16 ms, EN 60068-2-29

Classification

Customs tariff number 85371091
 eCl@ss 8.0 27243101
 eCl@ss 9.0 27243101
 ETIM 5.0 EC002538
 ETIM 6.0 EC002538

Dimensioned drawings

All dimensions in millimeters

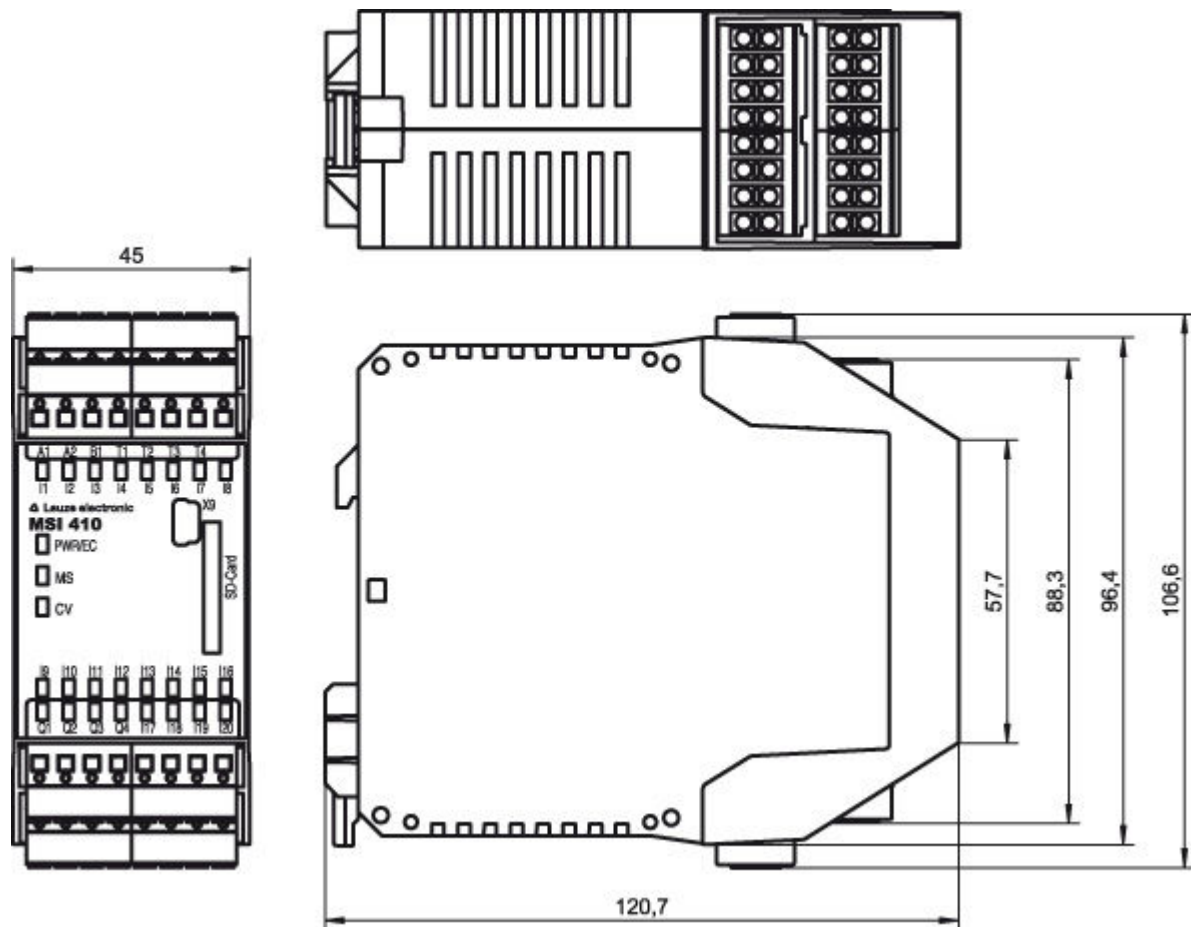

Electrical connection

Connection 1	
Type of connection	Terminal
Function	Signal IN Signal OUT Voltage supply
Type of terminal	Spring-cage terminal
No. of pins	31 -pin

Terminal	Assignment
A1	+24V
A2	GND
B1	+24 V (outputs Q1 - Q4)
I1	Safe input
I2	Safe input
I3	Safe input
I4	Safe input
I5	Safe input
I6	Safe input
I7	Safe input

Terminal	Assignment
I8	Safe input
I9	Safe input
I10	Safe input
I11	Safe input
I12	Safe input
I13	Safe input
I14	Safe input
I15	Safe input
I16	Safe input
I17	Safe input
I18	Safe input
I19	Safe input
I20	Safe input
Q1	Safe output
Q2	Safe output
Q3	Safe output
Q4	Safe output
T1	Test signal output
T2	Test signal output
T3	Test signal output
T4	Test signal output

Connection 2	X9
Type of connection	USB
Function	Configuration interface
Connector type	USB 2.0 Mini-A

Circuit diagrams

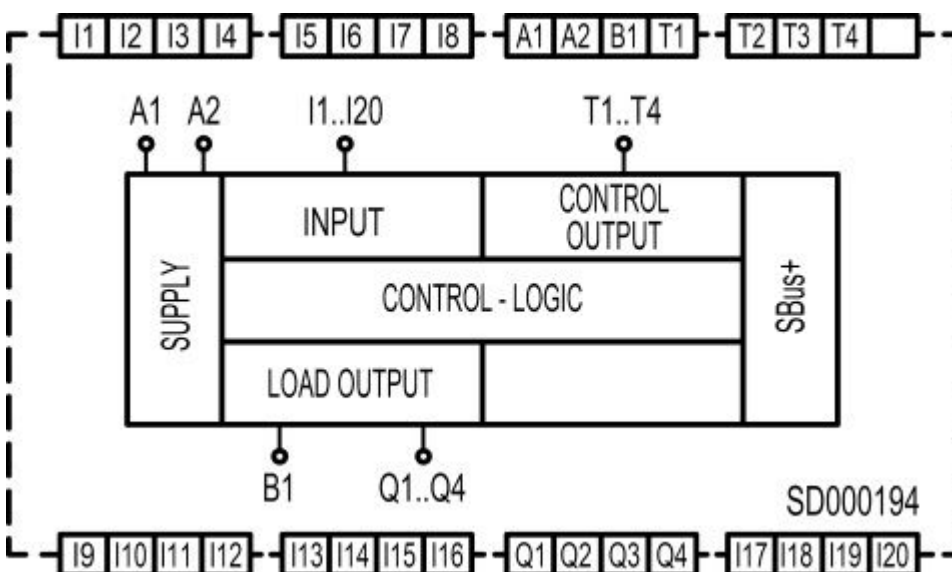

Notes



Observe intended use!
<ul style="list-style-type: none"> The product may only be put into operation by competent persons. Only use the product in accordance with its intended use.

Accessories

Start-up/diagnosis



	Part no.	Designation	Article	Description
	50117011	KB USB A - USB miniB	Service line	Suitable for interface: USB Connection 1: USB Connection 2: USB Shielded: Yes Cable length: 1,500 mm Sheathing material: PVC

General

	Part no.	Designation	Article	Description
	50132996 *	MSI-SD-CARD	Program memory	
	50133002	MSI-SD-COVER	Cover	Contains: 10x MSI-SD-COVER

* Necessary accessories, please order separately

Services

	Part no.	Designation	Article	Description
	S981043	CS40-E-312	Hourly rate for "Safety Engineering"	Details: Location and content to be agreed upon. Conditions: Price not including travel costs and, if applicable, accommodation expenses. Restrictions: Travel costs and accommodation expenses charged separately and, if applicable, according to expenditure.
	S981029	CS40-T-110	Product training	Details: Location and content to be agreed upon, duration: max. 10 hours. Conditions: Price not including travel costs and, if applicable, accommodation expenses. Restrictions: Travel costs and accommodation expenses charged separately and according to expenditure.