



Part no.: 50131374
CSL505-T05-395-M8
Light curtain transmitter



Figure can vary



Contents

- Technical data
- Dimensioned drawings
- Electrical connection
- Operation and display
- Suitable receivers
- Part number code
- Accessories

Part no.: 50131374 – CSL505-T05-395-M8 – Light curtain transmitter

Technical data

Basic data	
Series	505
Operating principle	Throughbeam principle
Device type	Transmitter
Application	Precise object detection

Optical data	
Operating range	Guaranteed operating range
Operating range	0.3 ... 5 m
Measurement field length	355 mm
Number of beams	72 Piece(s)
Beam spacing	5 mm
Light source	LED , Infrared
LED light wavelength	860 nm

Measurement data	
Minimum object diameter	7.5 mm

Electrical data	
Protective circuit	Inductive protection Polarity reversal protection Short circuit protected

Performance data	
Supply voltage U_B	18 ... 30 V , DC

Connection	
Number of connections	1 Piece(s)

Connection 1	
Type of connection	Connector
Function	Deactivation input Voltage supply
Thread size	M8
Type	Male
Material	Metal
No. of pins	4 -pin
Encoding	A-coded

Mechanical data	
Design	Cubic
Dimension (W x H x L)	12 mm x 440 mm x 58 mm
Housing material	Metal , Aluminum
Lens cover material	Plastic
Housing color	Silver
Type of fastening	Through-hole mounting

Operation and display	
Type of display	LED
Number of LEDs	1 Piece(s)

Part no.: 50131374 – CSL505-T05-395-M8 – Light curtain transmitter

Type of configuration	Software Via pin assignment
-----------------------	--------------------------------

Environmental data	
Ambient temperature, operation	-30 ... 50 °C
Ambient temperature, storage	-40 ... 65 °C

Certifications	
Degree of protection	IP 65
Protection class	III

Classification	
Customs tariff number	90314990
eCl@ss 8.0	27270910
eCl@ss 9.0	27270910
ETIM 5.0	EC002549
ETIM 6.0	EC002549

Dimensioned drawings

All dimensions in millimeters

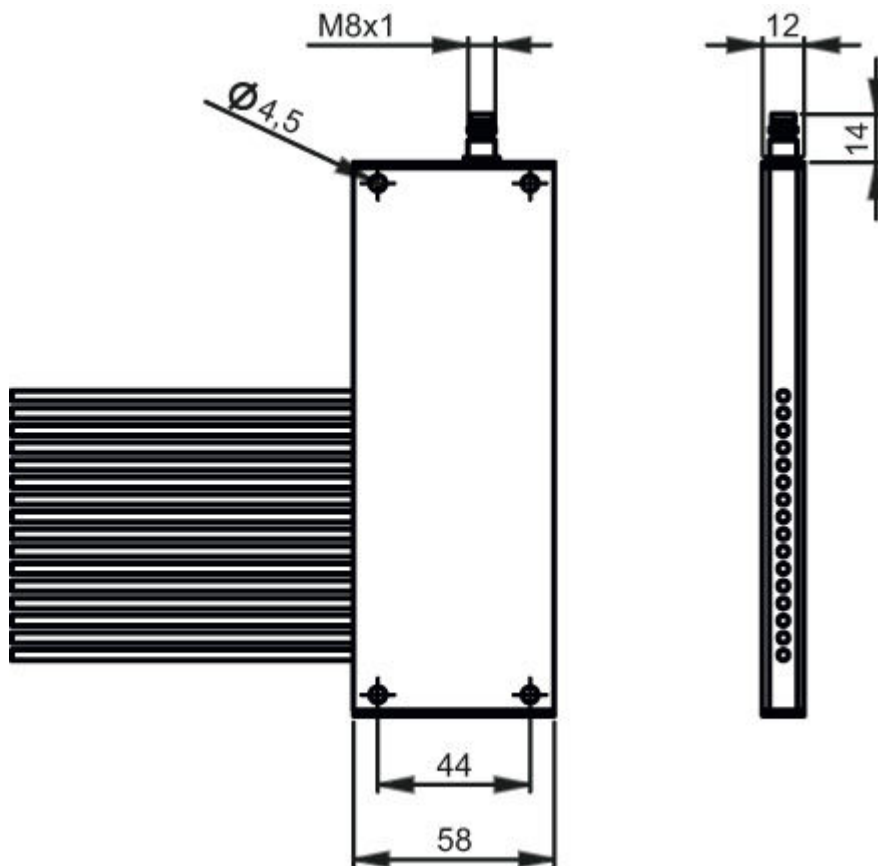

Electrical connection

Connection 1	
Type of connection	Connector
Function	Deactivation input Voltage supply
Thread size	M8
Type	Male
Material	Metal
No. of pins	4 -pin
Encoding	A-coded

Pin	Pin assignment
1	V+
2	n.c.
3	GND
4	IN 1

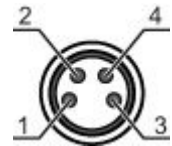

Operation and display

LEDs

LED	Display	Meaning
1	Off	Off
	Red, continuous light	Operational readiness
	Red, flashing	Error

Suitable receivers

	Part no.	Designation	Article	Description
	50131317	CSL505-R05-395-M8	Light curtain receiver	Application: Precise object detection Operating range: 0.3 ... 5 m Digital switching outputs: 2 Piece(s) Switching output: Transistor, Push-pull, Light/dark reversible Connection: Connector, M8, 4 -pin

Part number code

Part designation: **CSL505-XXXX-ZZZZ-AA**

X	Operating principle: T: transmitter R: receiver
YYY	Beam spacing: 05: 5 mm 12.5: 12.5 mm 25: 25 mm 50: 50 mm 100: 100 mm







Part no.: 50131374 – CSL505-T05-395-M8 – Light curtain transmitter

ZZZZ	Measurement field length: Measurement field length [mm], dependent on beam spacing
AA	Electrical connection: M8: M8 connector, 4-pin (plug)

Note
A list with all available device types can be found on the Leuze electronic website at www.leuze.com .

Accessories

Connection technology - Connection cables

	Part no.	Designation	Article	Description
  	50130850	KD U-M8-4A-V1-050	Connection cable	Connection 1: Connector, M8, Axial, Female, 4 -pin Connection 2: Open end Shielded: No Cable length: 5,000 mm Sheathing material: PVC
  	50130871	KD U-M8-4W-V1-050	Connection cable	Connection 1: Connector, M8, Angled, Female, 4 -pin Connection 2: Open end Shielded: No Cable length: 5,000 mm Sheathing material: PVC

	Part no.	Designation	Article	Description
	50132069	CSL505-Interface	Module	Connection: Sub-D Functions: Configuration and test device