



Part no.: 50131369
CSL505-T05-195-M8
Light curtain transmitter



Figure can vary



Contents

- Technical data
- Dimensioned drawings
- Electrical connection
- Operation and display
- Suitable receivers
- Part number code
- Accessories

Technical data

Basic data	
Series	505
Operating principle	Throughbeam principle
Device type	Transmitter
Application	Precise object detection

Optical data	
Operating range	Guaranteed operating range
Operating range	0.3 ... 5 m
Measurement field length	195 mm
Number of beams	40 Piece(s)
Beam spacing	5 mm
Light source	LED , Infrared
LED light wavelength	860 nm

Measurement data	
Minimum object diameter	7.5 mm

Electrical data	
Protective circuit	Inductive protection Polarity reversal protection Short circuit protected

Performance data	
Supply voltage U_B	18 ... 30 V , DC

Connection	
Number of connections	1 Piece(s)

Connection 1	
Type of connection	Connector
Function	Deactivation input Voltage supply
Thread size	M8
Type	Male
Material	Metal
No. of pins	4 -pin
Encoding	A-coded

Mechanical data	
Design	Cubic
Dimension (W x H x L)	12 mm x 280 mm x 58 mm
Housing material	Metal , Aluminum
Lens cover material	Plastic
Housing color	Silver
Type of fastening	Through-hole mounting

Operation and display	
Type of display	LED
Number of LEDs	1 Piece(s)

Part no.: 50131369 – CSL505-T05-195-M8 – Light curtain transmitter

Type of configuration	Software Via pin assignment
-----------------------	--------------------------------

Environmental data

Ambient temperature, operation	-30 ... 50 °C
Ambient temperature, storage	-40 ... 65 °C

Certifications

Degree of protection	IP 65
Protection class	III

Classification

Customs tariff number	90314990
eCl@ss 8.0	27270910
eCl@ss 9.0	27270910
ETIM 5.0	EC002549
ETIM 6.0	EC002549

Dimensioned drawings

All dimensions in millimeters

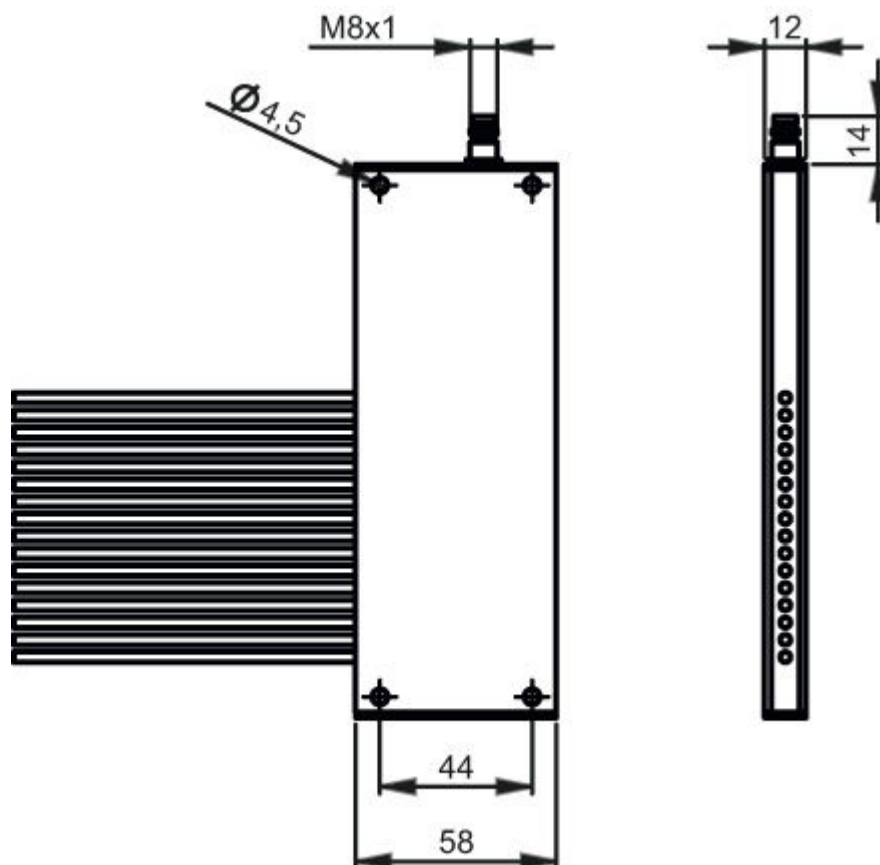

Electrical connection

Connection 1	
Type of connection	Connector
Function	Deactivation input Voltage supply
Thread size	M8
Type	Male
Material	Metal
No. of pins	4 -pin
Encoding	A-coded

Pin	Pin assignment
1	V+
2	n.c.
3	GND
4	IN 1

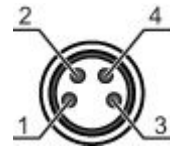

Operation and display

LEDs

LED	Display	Meaning
1	Off	Off
	Red, continuous light	Operational readiness
	Red, flashing	Error

Suitable receivers

	Part no.	Designation	Article	Description
	50131312	CSL505-R05-195-M8	Light curtain receiver	Application: Precise object detection Operating range: 0.3 ... 5 m Digital switching outputs: 2 Piece(s) Switching output: Transistor, Push-pull, Light/dark reversible Connection: Connector, M8, 4 -pin

Part number code

Part designation: **CSL505-XXXX-ZZZZ-AA**

X	Operating principle: T: transmitter R: receiver
YYY	Beam spacing: 05: 5 mm 12.5: 12.5 mm 25: 25 mm 50: 50 mm 100: 100 mm





Part no.: 50131369 – CSL505-T05-195-M8 – Light curtain transmitter

ZZZZ	Measurement field length: Measurement field length [mm], dependent on beam spacing
AA	Electrical connection: M8: M8 connector, 4-pin (plug)

Note
A list with all available device types can be found on the Leuze electronic website at www.leuze.com .

Accessories

Connection technology - Connection cables

	Part no.	Designation	Article	Description
 	50130850	KD U-M8-4A-V1-050	Connection cable	Connection 1: Connector, M8, Axial, Female, 4 -pin Connection 2: Open end Shielded: No Cable length: 5,000 mm Sheathing material: PVC
 	50130871	KD U-M8-4W-V1-050	Connection cable	Connection 1: Connector, M8, Angled, Female, 4 -pin Connection 2: Open end Shielded: No Cable length: 5,000 mm Sheathing material: PVC

	Part no.	Designation	Article	Description
	50132069	CSL505-Interface	Module	Connection: Sub-D Functions: Configuration and test device