



**Part no.: 50130606**  
**MD 7XXP-11-42IO5-13**  
**Distribution box**



Figure can vary

## Contents

- Technical data
- Dimensioned drawings
- Circuit diagrams
- Operation and display
- Accessories

## Technical data

<b>Electrical data</b>	
Switching signal	PNP
<b>Performance data</b>	
Total current	8 A
<b>Connection</b>	
<b>Master connection</b>	
Type of connection	Connector
Function	Connection to the control
Thread size	M23
No. of pins	12 -pin
Encoding	A-coded
Type	Male
<b>Distribution box connections</b>	
Number of connections	4 Piece(s)
Thread size	M12
No. of pins	5 -pin
Encoding	A-coded
Type	Female
Material	Plastic
Material of O-ring seal	TPU
Material of contacts	Gold-plated
Operating current per contact	1.5 A
<b>Mechanical data</b>	
Design	Cubic
Dimension (W x H x L)	50 mm x 36.5 mm x 100 mm
Housing material	Plastic
Net weight	105 g
<b>Operation and display</b>	
Type of display	LED
<b>Environmental data</b>	
Ambient temperature, operation, flexible use	-20 ... 70 °C
Ambient temperature, operation, stationary use	-20 ... 70 °C
<b>Certifications</b>	
Degree of protection	IP 65 IP 67
Certifications	c UL US
<b>Classification</b>	
Customs tariff number	85369010
eCl@ss 8.0	27279219
eCl@ss 9.0	27440108
ETIM 5.0	EC002585
ETIM 6.0	EC002585

## Dimensioned drawings

All dimensions in millimeters

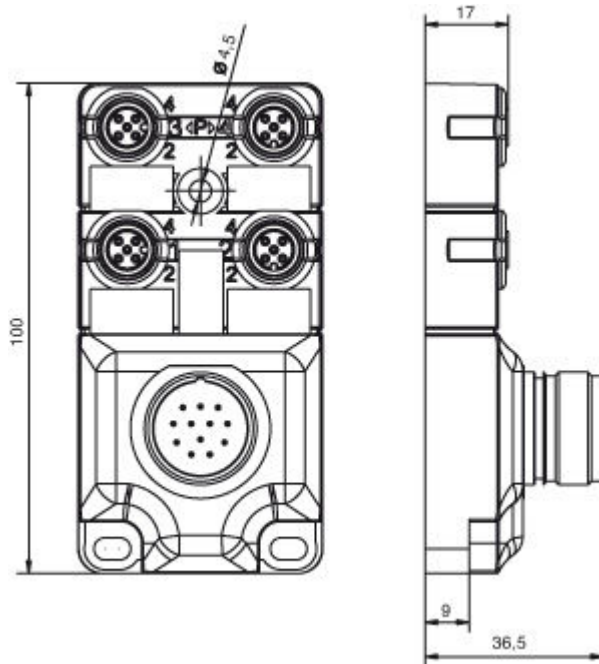

Pin	Pin assignment
1	Socket 1 / contact 4
2	Socket 2 / contact 4
3	Socket 3 / contact 4
4	Socket 4 / contact 4
5	Socket 1 / contact 2
6	Socket 2 / contact 2
7	Socket 3 / contact 2
8	Socket 4 / contact 2
9	Socket 1-4 / contact 3
10	Socket 1-4 / contact 3
11	Socket 1-4 / contact 1
12	Socket 1-4 / contact 5

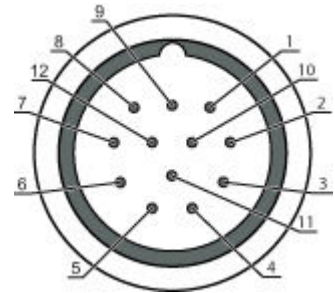

Pin	Pin assignment
1	+
2	Signal 2 (NC)
3	-
4	Signal 1 (NO)
5	PE

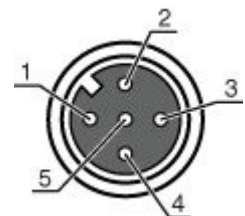

## Circuit diagrams

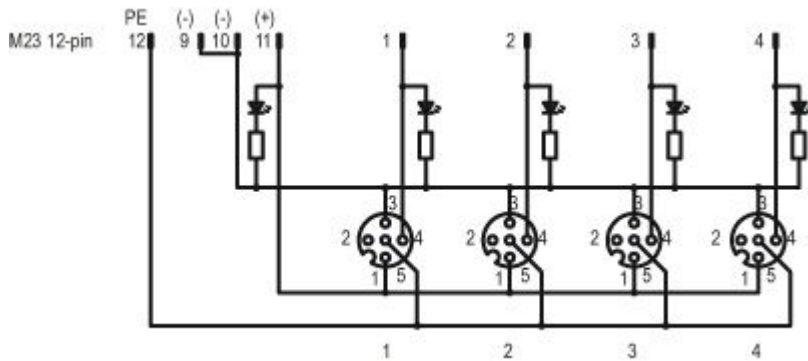



## Operation and display

### LEDs

LED	Display	Meaning
1	Green, continuous light	Operating voltage applied
2	Yellow, continuous light	Signal 1
3	White, continuous light	Signal 2

## Accessories

### Connection technology - Connection cables

	Part no.	Designation	Article	Description
	50134969	KD U-M23-CA-P1-050	Connection cable	Connection 1: Connector, M23, Axial, Female, A-coded, 12 -pin Connection 2: Open end Shielded: No Cable length: 5,000 mm Sheathing material: PUR
	50134973	KD U-M23-CW-P1-050	Connection cable	Connection 1: Connector, M23, Angled, Female, A-coded, 12 -pin Connection 2: Open end Shielded: No Cable length: 5,000 mm Sheathing material: PUR

## General

	Part no.	Designation	Article	Description
	50134480	CAP M12K-Set	Connection cap	Type: Cap for free sockets Thread size: M12 Material: Plastic