

## MSC 900 Controller



EN 2016/01 - 50130073  
Subject to change  
without prior notice

# CONTENTS

---

<b>REFERENCES</b> .....	<b>v</b>
Reference Documentation .....	v
Support Through the Website .....	v
<b>COMPLIANCE</b> .....	<b>vi</b>
FCC Compliance .....	vi
CE Compliance .....	vi
<b>GENERAL VIEW</b> .....	<b>vii</b>
<b>GUIDE TO INSTALLATION</b> .....	<b>viii</b>
Setting Up a Redundant (REDS) System .....	viii
<b>1 INTRODUCTION</b> .....	<b>1</b>
1.1 Product Description .....	1
1.2 Model Description .....	3
1.3 LED Indicators .....	3
<b>2 MECHANICAL INSTALLATION</b> .....	<b>5</b>
2.1 Package Contents .....	5
2.2 Mechanical Mounting .....	7
2.3 Electrical Connections .....	8
2.3.1 Main Interface .....	8
2.3.2 Auxiliary Interface .....	12
2.3.3 Ethernet Interface .....	13
2.3.4 Profibus Interface .....	14
2.4 Typical Layouts .....	15
2.4.1 Large Synchronized Network Layout .....	15
2.4.2 Redundant System Layout .....	18
2.5 Keypad and Display .....	22
2.5.1 How to Get to the Boot Loader .....	22
2.5.2 How to Default the MSC 900 .....	22
2.5.3 How to Get to the Menu Functions .....	22
2.5.4 Standard Mode .....	22
2.5.5 Redundancy Mode .....	27
2.5.6 Menu Mode .....	27
<b>3 USER INTERFACE</b> .....	<b>29</b>
3.1 Getting Started .....	29
3.1.1 Prerequisites .....	29
3.1.2 Starting the User Interface .....	30
3.2 User Interface Basics .....	32
3.2.1 MSC 900 User Interface Menu Tree .....	32
3.2.2 Entering Text Using the Text Entry Tool .....	32
3.2.3 Getting Help .....	33
3.3 Modify Settings .....	34
3.4 Modify Settings   System Info .....	35
3.5 Modify Settings   Global Settings .....	38
3.5.1 Modify Settings   Global Settings   Operating Mode .....	39
3.5.2 Modify Settings   Global Settings   Barcode Settings Table .....	56
3.5.3 Modify Settings   Global Settings   Barcode Configuration .....	61
Strip Filter Settings .....	65
Strip Filter Settings .....	70

Strip Filter Settings.....	84
3.5.4 Modify Settings   Global Settings   Serial Ports .....	85
3.5.5 Modify Settings   Global Settings   Ethernet .....	89
User Socket <i>n</i> .....	92
3.5.6 Fieldbus .....	97
3.5.7 Modify Settings   Global Settings   Messaging.....	100
3.5.8 Modify Settings   Global Settings   Digital I/O .....	121
3.5.9 Modify Settings   Global Settings   Diagnostics .....	124
3.5.10 Modify Settings   Global Settings   Energy Saving.....	126
3.5.11 Modify Settings   Global Settings   HMI Settings (Human-Machine Interface).....	131
3.5.12 Redundant Operation.....	131
3.6 Device Settings .....	133
3.6.1 Device Settings   Device Name   Device Info .....	134
3.6.2 Device Settings   Device Name   Mounting.....	136
3.6.3 Device Settings   Device Name   Options .....	138
3.7 Diagnostics .....	140
3.7.1 Diagnostics   Monitor.....	141
3.7.2 Diagnostics   Read Test .....	143
3.7.3 Diagnostics   Status Viewer.....	144
3.8 Utilities .....	147
3.8.1 Utilities   Backup or Restore .....	147
3.8.2 Utilities   Reboot.....	149
3.8.3 Utilities   Update Firmware .....	150
3.8.4 Utilities   Help .....	152
<b>4 MAINTENANCE .....</b>	<b>153</b>
4.1 Backup and Automatic Replacement Procedure .....	153
4.1.1 Backing Up the System Using the MSC 900 Keypad .....	153
4.1.2 Backing Up the System Using the User Interface.....	153
4.1.3 Replacing an MSC 900 .....	154
<b>5 TROUBLESHOOTING.....</b>	<b>155</b>
5.1 Error Codes and Resolutions .....	156
5.2 Troubleshooting Guide.....	161
<b>6 TECHNICAL FEATURES .....</b>	<b>164</b>
<b>INDEX.....</b>	<b>165</b>

# REFERENCES

---

## REFERENCE DOCUMENTATION

The documentation related to the MSC 900 is listed below:

- Guide to Installing a Redundant System

## SUPPORT THROUGH THE WEBSITE

Leuze electronic provides several services as well as technical support through its website. Log on to [www.leuze.de](http://www.leuze.de) and click on **PRODUCTS** for further information:

- **PRODUCTS – STATIONARY BARCODE READERS**

Select your product from the links on the **Stationary Barcode Readers** page. The product page describes specific Info, Features, Applications, Models, Accessories, and Downloads including documentation, software drivers, and utility programs.

# COMPLIANCE

---

## FCC COMPLIANCE

Modifications or changes to this equipment without the expressed written approval of Leuze electronic could void the authority to use the equipment.

This device complies with PART 15 of the FCC Rules. Operation is subject to the following two conditions: (1) This device may not cause harmful interference, and (2) this device must accept any interference received, including interference which may cause undesired operation.

This equipment has been tested and found to comply with the limits for a Class A digital device, pursuant to part 15 of the FCC Rules. These limits are designed to provide reasonable protection against harmful interference when the equipment is operated in a commercial environment. This equipment generates, uses, and can radiate radio frequency energy and, if not installed and used in accordance with the instruction manual, may cause harmful interference to radio communications. Operation of this equipment in a residential area is likely to cause harmful interference in which case the user will be required to correct the interference at his own expense.

## CE COMPLIANCE



**WARNING:** This is a Class A product. In a domestic environment this product may cause radio interference in which case the user may be required to take adequate measures.

# GENERAL VIEW

---

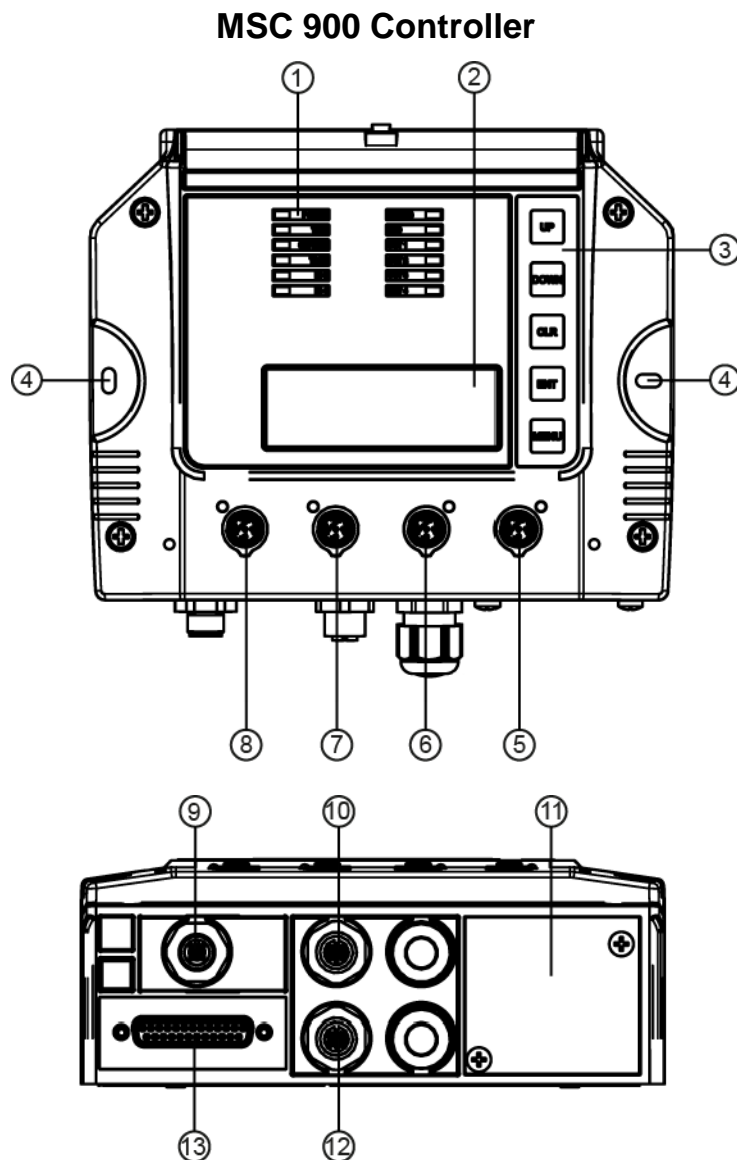

**Figure A – General View**

- ① Indicator LEDs
- ② Display
- ③ HMI 5-Key Keypad
- ④ Mounting Holes (2)
- ⑤ EBC Scanner Network Connector
- ⑥ EBC Scanner Network Connector
- ⑦ Ethernet Host Connector
- ⑧ Ethernet Configuration Connector
- ⑨ Power Connector
- ⑩ Encoder/Tach Input Connector
- ⑪ Host Interface Panel (Fieldbus Models)
- ⑫ Trigger Input Connector
- ⑬ MSC 900 to MA 900 Connector (for Serial Host and I/O)  
(with IP65 protection cap not shown)
- ⑭ Front Panel Connector Guard (not shown)

# GUIDE TO INSTALLATION

---

The following can be used as a checklist to verify all the steps necessary to complete installation of the MSC 900 Controller.

1. Read all information in the section “Compliance” at the beginning of this manual.
2. Correctly mount the MSC 900.
3. Connect the MSC 900 Controller to the PWR by means of the appropriate accessory cables.
4. Provide correct and complete system cabling according to the signals (Ethernet, EBC cluster, encoder P.S., etc) necessary for the layout of your application. (See subparagraphs under sections 2.3 and 2.4.
5. Configure the MSC 900 Controller by connecting a PC to the MSC 900 CFG port.

For configuration of a cluster of BCL 900i scanner, *see section 2.4.1.*

6. Execute the Backup procedure described in section 3.8.1.
7. Exit the configuration program and run your application.

The installation is now complete.



NOTE: If required mount the cable protection bracket onto the MSC 900 front cover.

## SETTING UP A REDUNDANT (REDS) SYSTEM

If you need to set up a redundant (REDS) system requiring Two MSC 900 Controllers, use the following checklist.

8. Build the internal EBC network (see section 2.4.2).
9. Configure the topological role of the two MSC 900s (see section 3.5.12).
10. Do the network discovery (see section 3.4).
11. Configure the Working controller.
12. Perform system backup (see section 3.8.1.)

# 1 INTRODUCTION

---

## 1.1 PRODUCT DESCRIPTION

The MSC 900 Controller offers all the necessary functions to make the phases of installation, setup, testing, and maintenance of the omnidirectional reading tunnel easy and quick.

The MSC 900 Controller key functions are:

- Bus Controller: cluster management and Host interface of a multisided reading tunnel based on EBC (Ethernet Based Communication) bus;
- Automatic replacement procedure: automatic procedure for scanner and bus controller replacement;
- Diagnostic indications on the reading station status, simple to be detected without any PC needed. This indications, based on LEDs and display, offer to the maintenance staff all the necessary information;
- Easy remotization of all the reading station information, thanks to built-in Ethernet and fieldbus (Profibus) connectivity;
- Single and Redundant System configurations;
- Auto PackTrack Calibration procedure from MSC 900 Menu using the onboard Keypad and Display.
- Energy Saving allows turning on/off the motors and lasers of all network scanners according to the selected digital input, encoder, or communication channel. The time required to restart the system is less than 1 minute independently from the number of scanners connected. It is suggested to use this parameter for example when the conveyor is stopped for a lengthy period.
- Three Inputs (Trigger, Encoder/Tachometer, IN3), three Outputs (OUT1, OUT2, OUT3), one configurable I/O Port (IN4/OUT4). See *GENERAL VIEW*.

**The MSC 900 Controller is divided into two parts:**

- The upper part (alloy case) contains the Controller's digital section; here you can find the four Ethernet M12 connectors, the removable SD-Flash memory, the display, the keypad and the LEDs.
- The lower part (plastic case) contains the connection board, the place for the optional Fieldbus modules and the connectors panel.



NOTE: The MSC 900 should be open only by authorized personnel.

The simple and sturdy mechanical structure makes the MSC 900 Controller the ideal solution for industrial environments.

The MSC 900 Controller is fully compatible with BCL 900i scanners.

The MSC 900 Controller allows connection to the Trigger and Encoder/Tach. PNP inputs are available via M12 circular connectors, placed on the lower front panel.

This configuration covers a great part of all the possible user's needs.



You can get access to all the Inputs and Outputs, in both PNP and NPN polarity, using the optional MA 900 connection box accessory; in this case you must connect the box to the controller using the KB 900 - 1000 MSC accessory cable.



**CAUTION:** The Trigger and Encoder signals must be supplied to only one device, that is, if you connect the Trigger or the Encoder to the MSC 900 M12 connectors you must not connect another Trigger or Encoder source to the MA 900!

## 1.2 MODEL DESCRIPTION

The MSC 900 Controller is available in the following versions:

<b>MSC 900 - 1000</b>	Standard Controller version (50129664)
<b>MSC 900 - 1100</b>	Profibus Controller version (50129665)

## 1.3 LED INDICATORS



Figure 1 – LEDs Description

### System Signal LEDs

#	Name	Color	State	Function
①	POWER	BLUE	ON OFF	MSC 900 Powered No Power
②	TRIG	GREEN	ON OFF	Photoelectric Sensor Active Photoelectric Sensor Not Active
③	SW-TRIG	GREEN	ON OFF	Software Trigger Acknowledge Active Software Trigger Acknowledge Not Active
④	TACH	GREEN	Blinking OFF	Encoder Active Encoder Inactive
⑤	IN3	GREEN	ON OFF	Input 3 Active Input 3 Inactive

#	Name	Color	State	Function
⑥	IN4	GREEN	ON OFF	Input 4 Active Input 4 Not Inactive
⑨	OUT1	YELLOW	ON OFF	Output 1 Active Output 1 Inactive
⑩	OUT2	YELLOW	ON OFF	Output 2 Active Output 2 Inactive
⑪	OUT3	YELLOW	ON OFF	Output 3 Active Output 3 Inactive
⑫	OUT4	YELLOW	ON OFF	Output 4 Active Output 4 Inactive

### System Event Status LEDs

#	Name	Color	State	Function
⑦	STATUS	GREEN / RED	ON Green ON Red OFF	Controller Status OK Scanner Cluster Failure Controller Not Ready
⑧	EBC	GREEN / YELLOW	ON Green ON Yellow OFF	EBC Network OK EBC Network Warning EBC Network Not Ready

### Ethernet Status LEDs

#	Name	Color	State	Function
⑬	CFG	YELLOW	Blinking	Ethernet CFG Port Activity
⑭	HOST	YELLOW	Blinking	Ethernet HOST Port Activity
⑮	ETH2	YELLOW	Blinking	EBC Port 2 Activity
⑯	ETH1	YELLOW	Blinking	EBC Port 1 Activity

## 2 MECHANICAL INSTALLATION

---

To install the system follow the given procedure:

1. Select the mounting location and mount the MSC 900 Controller.
2. Select the preferred power source to power the MSC 900 through the M12 Male 5p. connector (see *GENERAL VIEW*).
3. Proceed with system electrical connections.
4. Connect to the Configuration PC and modify the configuration parameters.

### 2.1 PACKAGE CONTENTS

Verify that the MSC 900 Controller and all the parts supplied with the equipment are present and intact when opening the packaging; the list of parts includes:

- MSC 900 Controller
- Protection guard for the Ethernet connectors, with its fixing screws
- MSC 900 Quick Reference Guide
- Mounting screws

Overall Dimensions

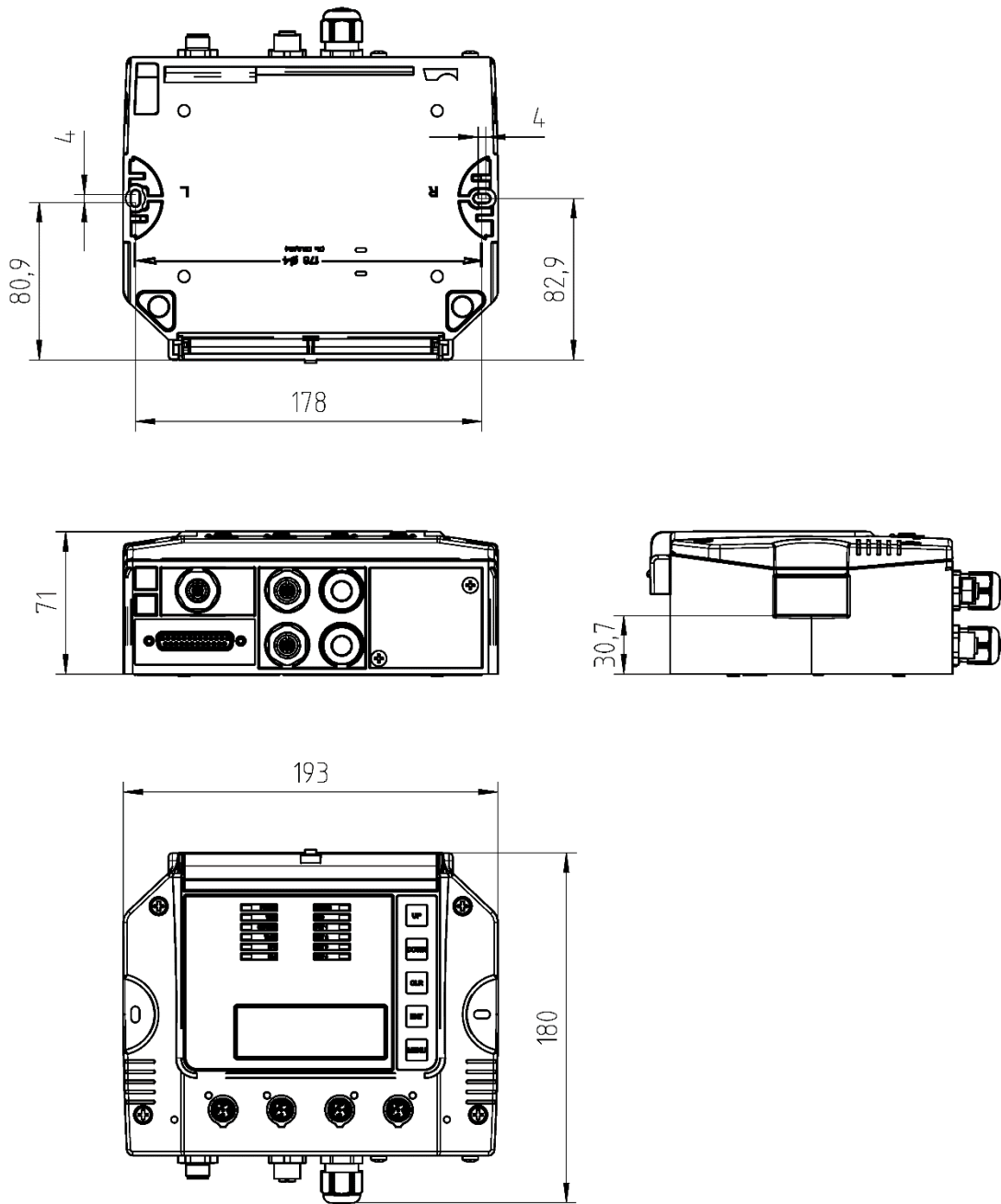

Figure 2 – MSC 900 Overall Dimensions

## 2.2 MECHANICAL MOUNTING

MSC 900 can be mounted to various wooden or plastic surfaces using two self-threading screws (3.9 x 45 mm) and washers.

Mounting to other surfaces such as concrete walls or metallic panels requires appropriate user-supplied parts (screws, screw anchors, nuts, etc.).

## 2.3 ELECTRICAL CONNECTIONS

The connectors available for each controller model are the following:

Controller Model	Connector	Type
<b>All models</b>	Power	M12 Male 5p. A-Coded
	Serial and Extended I/O	25-pin female
	Trigger	M12 Female 4p. A-Coded
	Encoder/Tachometer	M12 Female 5p. A-Coded
	Ethernet (x4)	4x M12 Female 4p. D-Coded
<b>MSC 900 - 1100</b>	Profibus (x2)	M12 Male 5p. B-Coded + M12 Female 5p. B-Coded

### 2.3.1 Main Interface

This interface is available exclusively through the MA 900 connection box accessory. Use the KB 900 - 1000 MSC accessory cable to connect the MA 900 to the MSC 900.

The optocoupled main serial interface is compatible with the following electrical standards:

- RS232
- RS422 full-duplex

## RS232 Interface

The main serial interface is used for communication with the Host computer and allows both transmission of code data and controller configuration.

It is always advisable to use shielded cables. The overall maximum cable length must be less than 15 m (49.2 ft).

The following positions of the MA 900 spring clamp connector (row 4) are used for RS232 interface connection:

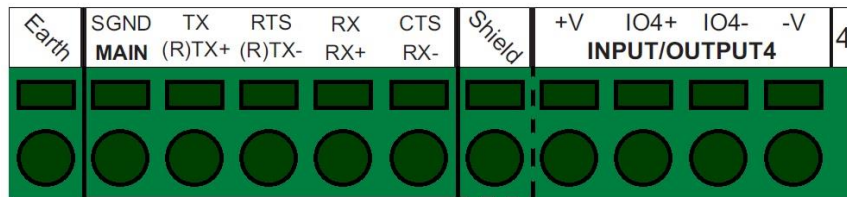

Name	Function
SGND	Signal ground (isolated)
TX	Transmit
RTS	Request to send
RX	Receive
CTS	Clear to send

As suggested above, the cable shield should be connected in the 'Shield' position.

The RTS and CTS signals control data transmission and synchronize the connected devices. If the RTS/CTS hardware protocol is enabled, the MSC 900 activates the RTS output to indicate a message can be transmitted. The Host must activate the CTS input to enable the transmission.

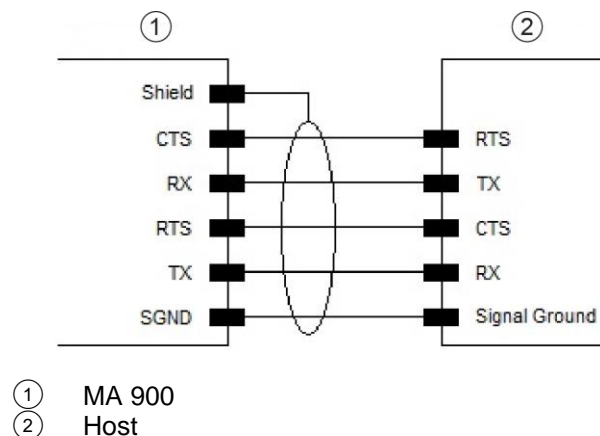

Figure 3 – RS232 Connections: Host – MA 900



## RS422 Full-Duplex Interface

The RS422 full-duplex interface is used for non-pollled communication protocols in point-to-point connections over longer distances (max 1200 m / 3940 ft) than those acceptable for RS232 communications or in electrically noisy environments.

The following positions of the MA 900 spring clamp connector (row 4) are used for RS422 full-duplex interface connection:

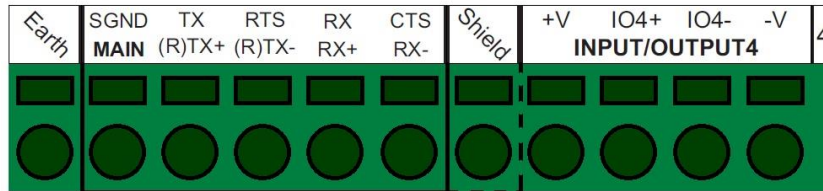

Name	Function
SGND	Signal ground (isolated)
TX+	RS422 output (+)
TX-	RS422 output (-)
RX+	RS422 input (+)
RX-	RS422 input (-)

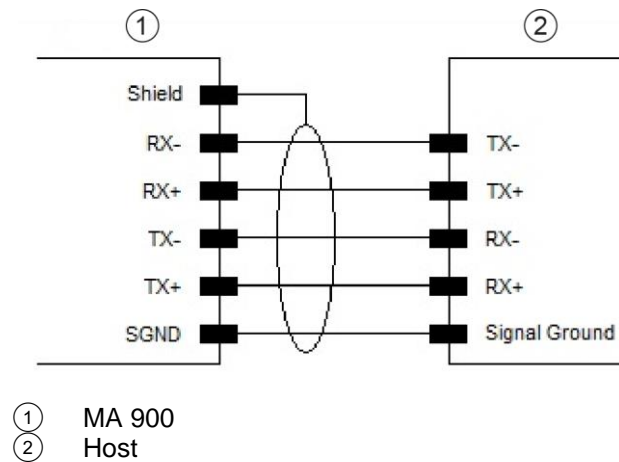

Figure 4 – RS422 Full-Duplex Interface Connections: Host – MA 900



**NOTE:** For applications that do not use RX422 signals, do not leave these lines floating but connect them to SGND as shown below.

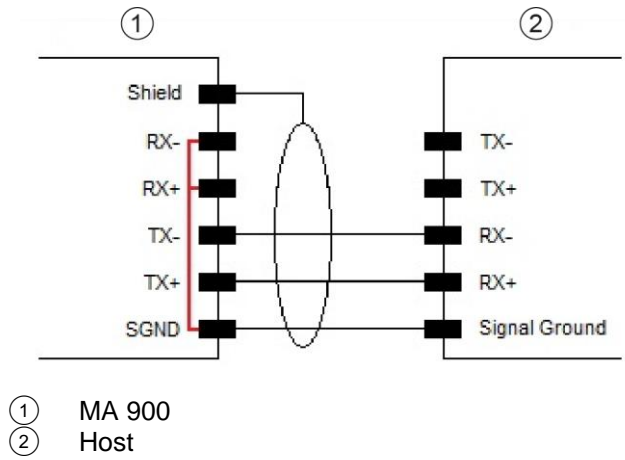

Figure 5 – RS422 Full-Duplex Interface Connections Using Only TX Signals: Host – MA 900

### 2.3.2 Auxiliary Interface

This interface is available exclusively through the MA 900 connection box accessory. Use the KB 900 - 1000 MSC accessory cable to connect the MA 900 to the MSC 900.

The auxiliary serial interface is equipped with RS232 interface connections. In addition to being an alternative serial interface, it can be used to connect a hand-held reader to the reading station in a pass through configuration. Data Transmission can be enabled or disabled on this interface through the configuration parameters.

The following pins of the 9-pin D-Sub Female connector inside the MA 900 are used for RS232 interface connection:

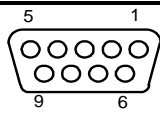
9-pin D-sub Female Connector Pinout			
Pin	Name	Function	
2	TX	Transmit	 <p>9-pin D-sub Female Connector</p>
3	RX	Receive	
5	GND	Ground	

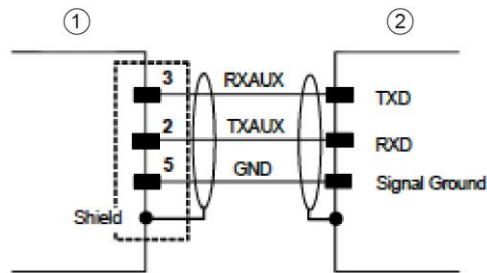

- ① MA 900
- ② USER INTERFACE (Laptop)

**Figure 6 – RS232 Auxiliary Interface Connections**

The 9-pin. connector is normally used for quick/temporary connection. For a more permanent connection you can also use the MA 900's spring clamp connectors, in particular the positions labeled as RX AUX, TX AUX and SGND AUX.

### 2.3.3 Ethernet Interface

Four standard M12 4-pin D-Coded female connectors are provided on the MSC 900's upper metal cover for the Ethernet connections: CFG, HOST, ETH2 and ETH1.

CFG is used for configuration purposes; HOST is used to connect the MSC 900 to an Ethernet Host; ETH2 and ETH1 are reserved for building the EBC cluster; typically the cluster members are BCL 900i scanners.

This interface is IEEE 802.3 10 BaseT and IEEE 802.3u 100 BaseTx compliant.

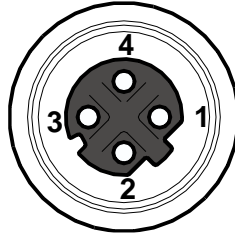

Figure 7 – M12 4-pin D-Coded Female Ethernet Network Connector

Ethernet Network Connector Pinout		
Pin	Name	Function
1	TX +	Transmitted data (+)
2	RX +	Received data (+)
3	TX -	Transmitted data (-)
4	RX -	Received data (-)

### 2.3.4 Profibus Interface

The Profibus interface is only available in the MSC 900-1100 Profibus model and allows inserting the controller in a Profibus network. :

A pair of Male and Female M12 5-pin B-Coded connectors are provided on the MSC 900's rightmost front panel for Profibus connections.

PB-IN (Profibus In) M12 5P Male (B-coded)			PB-OUT (Profibus Out) M12 5P Female (B-coded)		
Pin	Function		Pin	Function	
1	+5V Bus		1	+5V Bus	
2	A Line (-)		2	A Line (-)	
3	GND Bus		3	GND Bus	
4	B Line (+)	4	B Line (+)		
5	Shield	5	Shield		

Figure 8 – Profibus M12 5-pin B-Coded Male and Female Connectors

The Profibus interface is used for communication with a Profibus Host and allows expanding the networking and remote diagnostic capabilities of the controller.

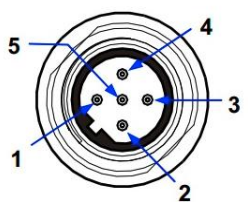
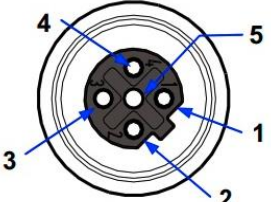

Figure 9 – Profibus Connectors

## 2.4 TYPICAL LAYOUTS

The following typical layouts refer to system hardware configurations, but also require the correct setup of the software configuration parameters

Other layouts require the use of a specific MSC 900 Controller model.

The accessories and cables indicated in the following figures are Leuze electronic products. We suggest their use to guarantee the correct system functioning.

### 2.4.1 Large Synchronized Network Layout

When building a large local EBC (Ethernet Based Connectivity) network, an MSC 900 Controller should be used. In this case the MSC 900 unit acts as the system master and is connected to the host through one of its interfaces.

- The MSC 900 can be connected to the Host in several different layouts depending on the controller model.

The MSC 900 Standard models provide both Ethernet connections (direct or through a Hub/Switch) and point-to-point connections on the Main interface using either RS232 or RS422 full-duplex;

Fieldbus models, additionally provide the model specific Fieldbus: Profibus, Profinet IO, etc.

- All scanners act as slaves and are connected to the MSC 900 through the EBC interface.

External devices such as a presence sensor and an encoder are all connected either to the MSC 900 through its M12 circular connectors, or to the MA 900 connection box (connected to the Controller), wiring the signals through the MA 900 compression connectors.

## MSC 900: Basic Layout: Ethernet TCP/IP To Host

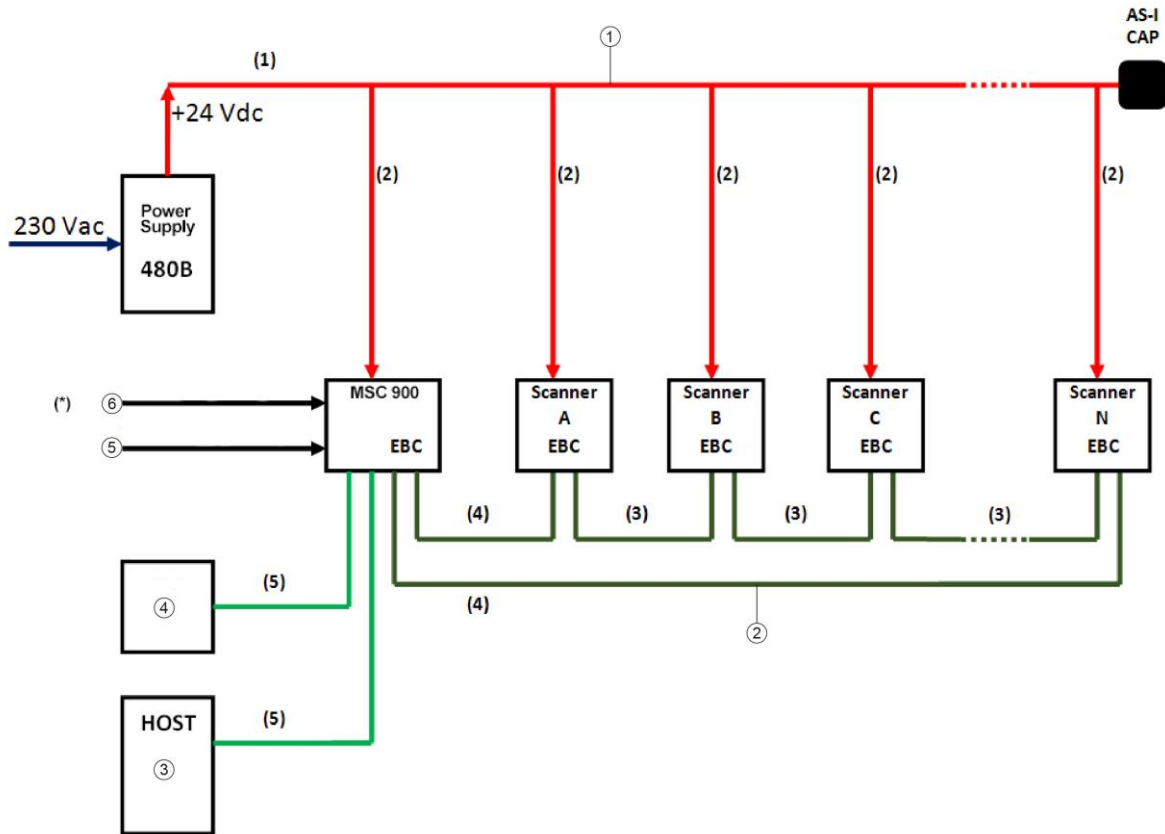

- ① AS-Interface (AS-I) Power Backbone
- ② EBC Ring layout
- ③ Ethernet
- ④ Laptop
- ⑤ Encoder (M12)
- ⑥ Trigger (M12)

- (1) PWR Cable AS-I 10 m/25 m
- (2) PWR Cable M12 – AS-I 1 m/2 m
- (3) Ethernet Cable M12-M12 Straight-Straight 1 m/3 m/5 m
- (4) Ethernet Cable M12-M12 Straight-90° 1 m/3 m/5 m
- (5) Ethernet Cable M12-RJ45 Straight-90° 5 m

(\* If you prefer an alternative wiring connection, rather than the M12 connection type, use the MA 900 accessory, as shown below.

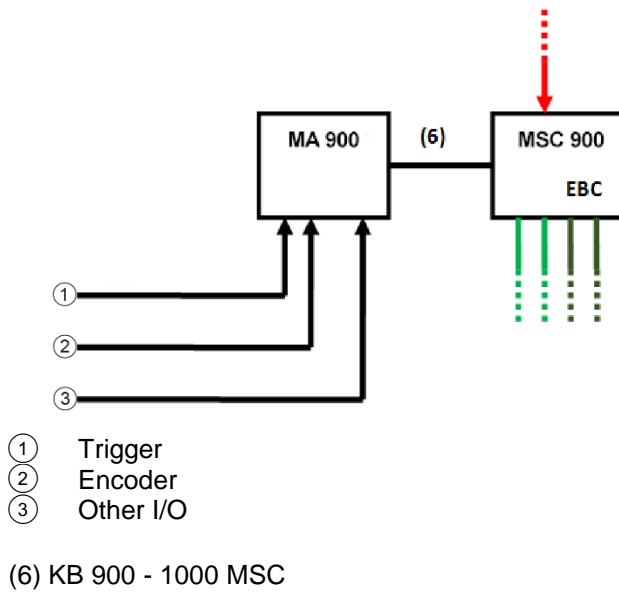

Figure 10 – Large Synchronized Network with BCL 900i Scanners

**MSC 900: Basic Layout: COM To Host**

If the Host supports a COM communication type (RS232 or RS422) rather than the Ethernet one, use the MA 900 accessory, as shown below.

The remaining part of the layout (scanners, PWR etc) does not change.

As already mentioned, the MA 900 can also be used to wire the Trigger and Encoder signals (and other I/O) as an alternative to the M12 connection.

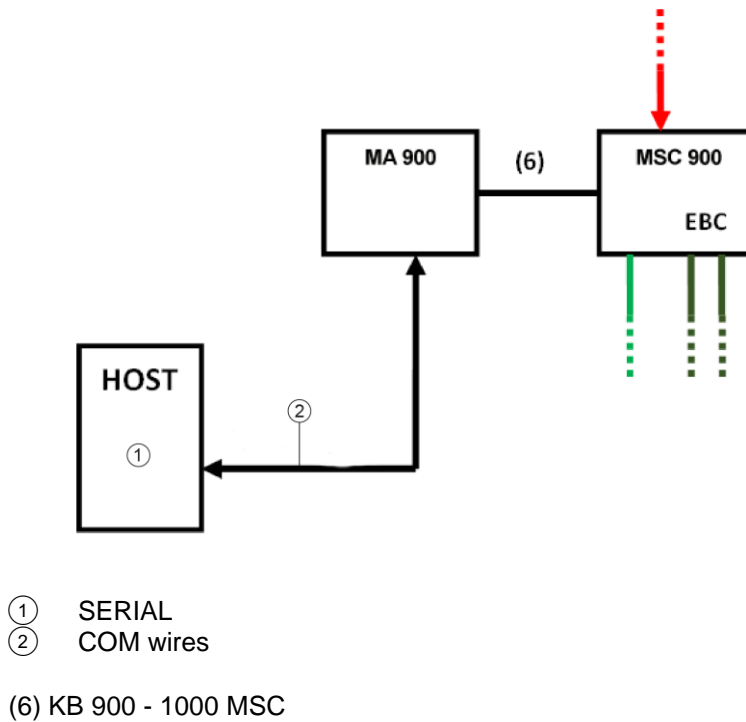

Figure 11 – Large Synchronized Network with COM to Host



## 2.4.2 Redundant System Layout

For large local EBC networks, a redundant system can be configured in which two MSC 900 Controllers are used together with their respective PWR power supply units. The scanners are distributed equally between the PWR units. In this case one of the MSC 900 Controllers is dedicated as the **Master Working** or active unit while the other functions as a dedicated **Master Protecting** or backup unit.

To set up a redundant system:

1. Connect a system of two MSC 900 and at least one BCL 900i. The network consists of a ring closed at the two MSC 900 Controllers.
2. Power up the system.
3. In the User Interface, set one of the MSC 900 Controllers with a Roll of Master Working, and the other with the Roll of Master Protecting (see section 3.5.12 **Redundant Operation**).
4. In the User Interface menu, navigate to **Modify Settings | System Info** and click **Discover Scanners**.

### MSC 900: Redundant System Layout with Ethernet TCP/IP to Host

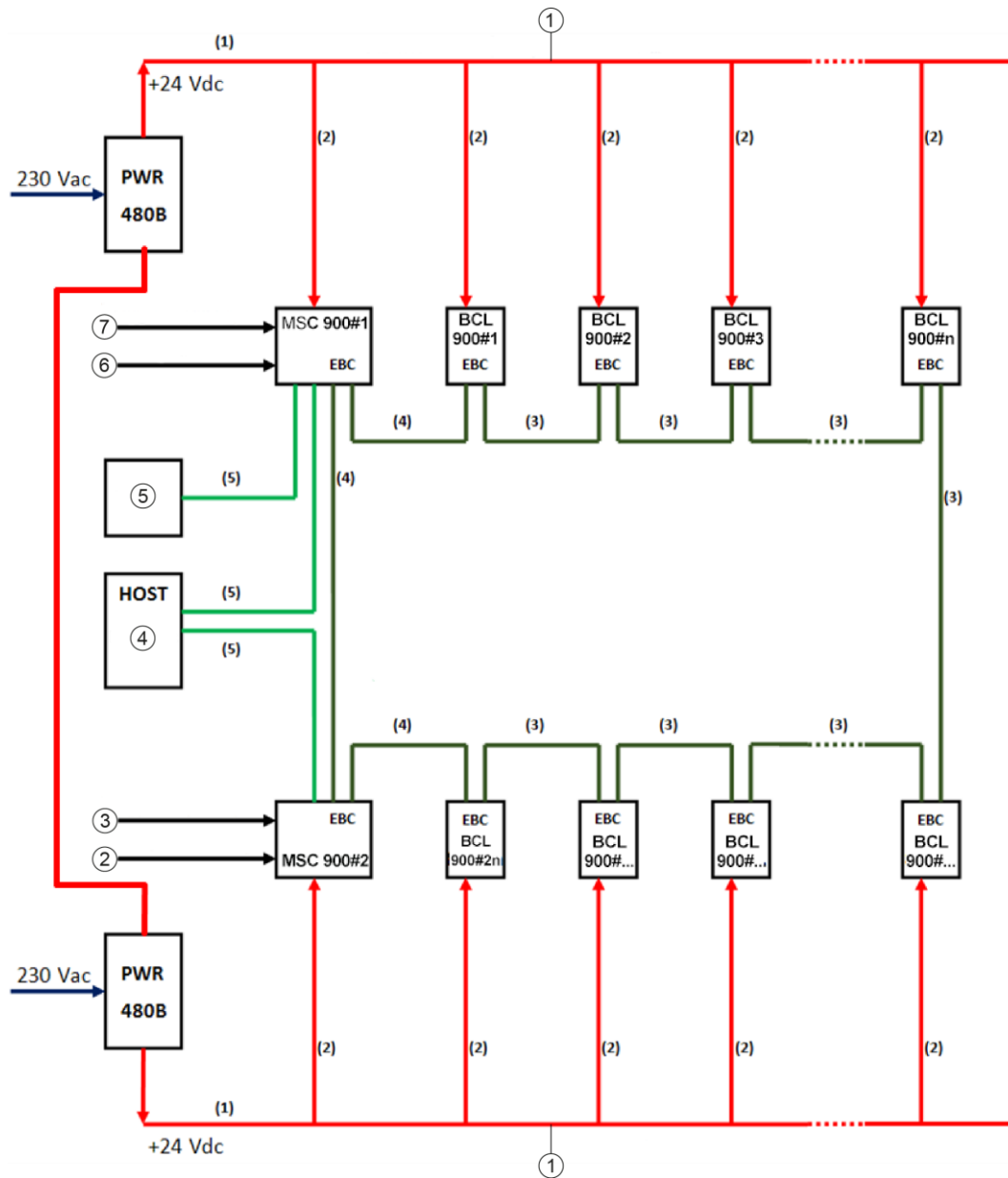

- ① AS-Interface (AS-I) Power Backbone
- ② Encoder2 (M12)
- ③ Trigger2 (M12)
- ④ Ethernet
- ⑤ Laptop
- ⑥ Encoder1 (M12)
- ⑦ Trigger1 (M12)

- (1) PWR Cable AS-I 10 m/25 m
- (2) PWR Cable M12 – AS-I 1 m/2 m
- (3) Ethernet Cable M12-M12 Straight-Straight 1 m/3 m/5 m
- (4) Ethernet Cable M12-M12 Straight-90° 1 m/3 m/5 m
- (5) Ethernet Cable M12-RJ45 Straight-90° 5 m

Figure 12 – Redundant Reading Station Layout with BCL 900i Scanners

### MSC 900: Redundancy Layout with Host Supporting Serial COM Communications

If the Host supports serial COM communications (type RS232 or RS422) rather than the Ethernet one, use one MA 900 accessory for each MSC 900 controller, as shown below.

The remaining part of the layout (scanners, PWR etc.) does not change.

As already mentioned, the MA 900 can also be used to wire the Trigger and Encoder signals (and other I/O) as an alternative to the M12 connection.

Moreover, for Redundancy layouts, it is recommended to connect the PWR-480B signals 13/14 (DC OK, normally closed pair), to a free input port in the MA 900; this should be done for each set PWR-480B - MA 900 - MSC 900. In this way each controller can monitor its Power Source cabinet, to signal an alarm in case of a PWR failure.

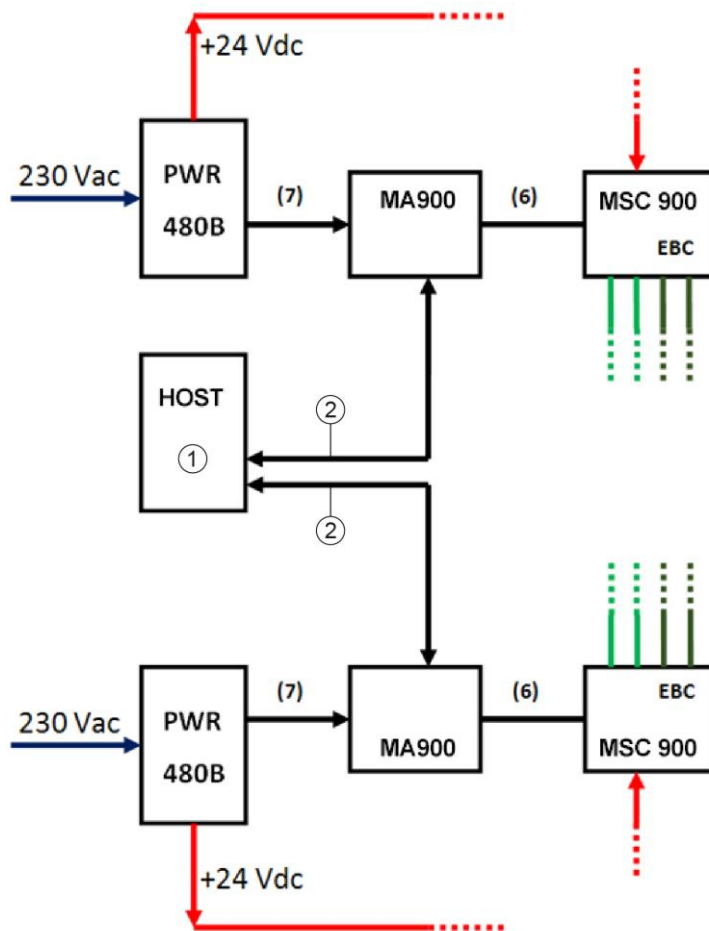

- ① SERIAL
- ② COM wires

- (6) KB 900 - 1000 MSC
- (7) Lines 13/14 connection to MA 900  
REDS POWER ALARM CABLE 5 mt

Figure 13 – Redundant Reading Station with Host Supported Serial Communications

### MSC 900: Redundancy Layout with Host Supporting a Single Serial Communication Port

If the Host only supports a single COM port (RS232 or RS422) rather than Ethernet, use one MA 900 accessory for each MSC 900 controller, as shown below.

**The remaining part of the layout (scanners, PWR etc) does not change.**

As already mentioned, the MA 900 can also be used to wire the Trigger and Encoder signals (and other I/O) as an alternative to the M12 connection.

In this case, it is necessary to connect the Host (RS232 or RS422) serial interface to a user supplied relay placed inside one of the PWR-480Bs. The relay is also connected to both MA 900 RS232 or RS422 Main Interfaces; one to the Working Controller (in the normally closed state and the other to the Protecting Controller in the open state. A free output from the MSC 900 controller will be configured to command the relay so that any event that causes the Redundancy switch will connect the Active Serial Interface to the Host.

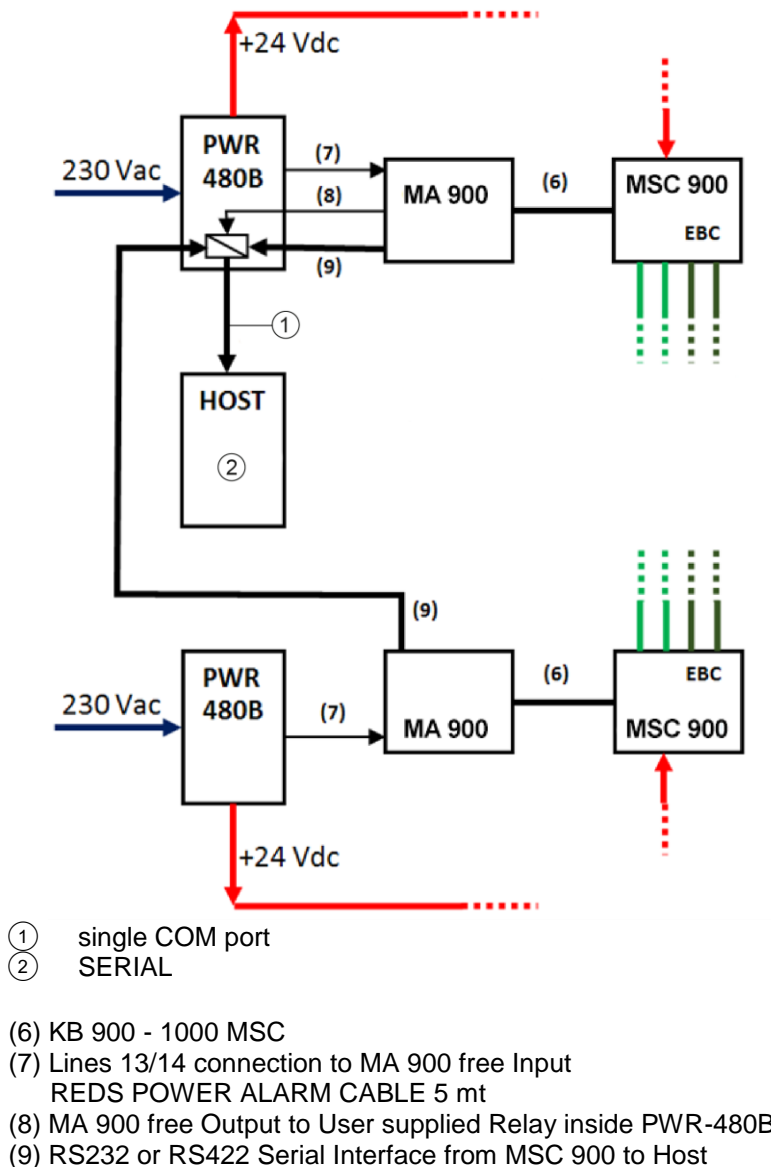

Figure 14 – Redundant Reading Station with Host Supporting a Single Serial Communication Port

## 2.5 KEYPAD AND DISPLAY

The MSC 900 display shows different messages according to the following operating modes. Use the MSC 900 keypad to scroll through the windows or navigate in the menu.

Symbols	Meaning
UP	Scroll up
DOWN	Scroll down
CLR	Clear
ENT	Enter
MENU	Menu

### 2.5.1 How to Get to the Boot Loader

To run the MSC 900 Boot Loader:

1. Disconnect power from the MSC 900.
2. Press and hold the MENU button on the MSC 900, and reapply power to the unit. The Boot Loader opens.

### 2.5.2 How to Default the MSC 900

If hardware release is equal to 1:

1. Disconnect power from the MSC 900.
2. Press and hold the **UP** and **MENU** buttons, and reapply power to the unit. The unit properties are defaulted.

If hardware release does not equal 1:

1. Disconnect power from the MSC 900.
2. Press and hold the **UP** and **CLEAR** buttons, and reapply power to the unit. The unit properties are defaulted.

### 2.5.3 How to Get to the Menu Functions

With the MSC 900 powered up, press the buttons **ENTER** and **MENU** at the same time.

### 2.5.4 Standard Mode

Upon startup, the Diagnostic Mask window is displayed by default. Using the **UP** and **DOWN** arrow keys it is possible to scroll through the following windows:

- 1) Diagnostic Mask Window
- 2) Reading Performance Window
- 3) Reading Mask Window
- 4) I/O Status Window
- 5) Conveyor Speed
- 6) System Info Window
- 7) Last Code & Read Mask
- 8) Alarms

## Diagnostic Mask Window (Default Window)

This window illustrates the status of each node (of each scanner of the cluster).

```

S c a n      * * * * *
S t a t e    A B C D E F G H
  
```



The slave scanners are listed as letters (**A**, **B**, **C**, etc.) [or numbers (**01**, **02**, **03**, etc.) depending on the *System.Global.ClusterInfo.UserInterfaceType* configuration].

Above each scanner position a symbol indicates the scanner status according to the following convention:

- From the startup the node has not been discovered.
- ? At the startup of the system the node has been discovered but it does not answer to the master.
- \* The node status is OK.
- ! The node returns an error code to the diagnostic Laser Off.
- & The node returns an error code to the diagnostic Motor Off.
- % The node returns a generic error.

Other messages can also be displayed:

<b>Empty scan cluster</b>	No scanner has been discovered within the cluster.
<b>No slave expected</b>	A scanner not expected by the system configuration has been discovered.
<b>Energy Saving</b>	The Energy Saving feature has been activated.

## Reading Performance Window

This window displays the following data:

```
P a c k o u t = 1 2 4 6 7
G o o d r e a d = 1 2 4 6 7
N o r e a d = 0
M u l t i p l e r e a d = 0
```

- Number of processed parcels
- Number of Good Reads
- Number of No Reads
- Number of Multiple Reads

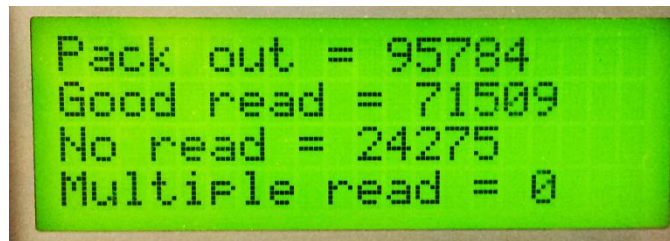

```
Pack out = 95784
Good read = 71509
No read = 24275
Multiple read = 0
```

## Reading Mask Window

This window indicates the node that performed a reading of the codes enabled on the master.

```
R e a d * *
m a s k A B C D E F G H
```



```
Read
mask AB
```

The following indicators are used:

- \* The node read a barcode enabled on the master.
- <space> The node read no barcode.

## I/O Status Window

This window provides data concerning the digital input/output status.

```

E N C = 0      P S = 0      P S A U X = 0
I N 1 = 1      I N 2 = 0      I N 3 = 0
O U T 1 = 0     O U T 2 = 0     O U T 3 = 0
O U T 4 = 0     O U T 5 = 0     O U T 6 = 0
  
```

0 = Low Level Signal

1 = High Level Signal

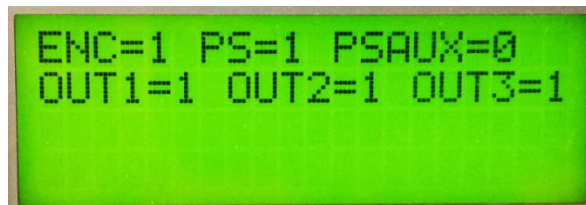

```

ENC=1 PS=1 PSAUX=0
OUT1=1 OUT2=1 OUT3=1
  
```

## Conveyor Speed Window

This window provides data concerning the conveyor speed.

```

C o n v e y o r   s p e e d
x x   ( m m / s e c )
x x   ( f t / m i n )
  
```



```

Conveyor speed:
849 (mm/sec)
167.1 (ft/min)
  
```

## System Info Window

This window provides information about the software release.

```

S C 5 0 0 0      8 K      M a s t e r
D L 8 K      v 0 _ 8 _ 2 _ 1
H o s t      1 7 2 . 0 2 7 . 1 0 1 . x x x
C f g      1 9 2 . 1 6 8 . 0 0 3 . 1 0 0
  
```



```

SC5000 8k master
SC5K_v0_8_5_6
Host 010.027.154.124
Cfg 192.168.003.100
  
```

For the Profibus model the Profibus Node Address is also displayed.



## Last Code & Read Mask

This window is available only when enabling the *Last Code & Reading Mask Window* parameter. It displays the following data fields

```

L a s t C o d e   &   R e a d M a s k
>   2 5 6 3 4 8 9 3 3 2 5 7 5 3 2 4 5 7
> A D
G 1 0 0 %   N 0 %   M 0 %   P 0 %

```

- Last read code (shown truncated if longer than 18 digits)
- List of nodes that performed the reading
- Statistics (Good Read Rate, No Read Rate, Multiple Read Rate, Partial Read Rate) calculated on the last 100 codes or in continuous mode depending on the *Last Code & Reading Mask Window* parameter selection.

```

LastCode & ReadMask
> LEUZE electronic
>A
G75% N25% M0% P0%

```

## Alarms

Specific diagnostic alarms are available only when they are enabled.

```

N o   a l a r m s

```

```

No alarms

```

Up to four alarms can be displayed at a time (one per line). They are generated by the network or by the MSC 900.

All alarms are ordered according to their priority (failure messages have priority over warning messages).

A failure message causes the Status LED to light up red.

If the Display Warnings as Alarms parameter is enabled, a warning message causes the Status LED to blink red.

## 2.5.5 Redundancy Mode

When working in a redundant system, the MSC 900 displays different windows according to its redundancy role.

### MSC 900 Active Controller Window

The MSC 900 working as active controller displays the diagnostic mask window, as if it is working in a single master network.

### MSC 900 Standby Controller Window

This window is displayed on the MSC 900 working as standby controller. It illustrates the topology redundancy role of the controller:

- “Protecting/Standby” or “Working/Standby”

## 2.5.6 Menu Mode

For security purposes, the menu mode is entered by pressing the **Enter** and **Menu** keys at the same time. To navigate in the menus the keypad keys are used as follows:

- Press **Enter** to select an item or enter a branch level.
- Press **Clear** to exit an item without saving or return to the previous branch level.
- Press the **Up** or **Down** arrow keys to scroll through a branch list.

It is possible to access the **System** menu, **Setup** parameters menu:

Menu	Branch	Branch	Note
System			
	Info	Shows the System Info Window	
	Reset	Reset the system	(asks for confirmation)
	Restore	Complete Restore procedure	(asks for confirmation)
	Backup	Complete Backup system configuration	(asks for confirmation)
	Mib Dist	Distribute the MIB on the tunnel	(asks for confirmation)
	SW Dis	Distribute the SW on the tunnel	

The Backup and Restore procedures can also be performed by GUI. See *section 3.8.1*.

Setup	Time		Set system time: Up & Down to change values, Enter to change fields, at last field Enter exits saving new values. <b>Not yet supported</b>
	Date		Set system date: Up & Down to change values, Enter to change fields, at last field Enter exits saving new values. <b>Not yet supported</b>
	Ethernet		Ethernet interface
		Host IP	Set IP Address of the Host Eth port
		Cfg IP	Set IP Address of the Cfg Eth port
		GW address	Set IP address of the gateway for the Host port
		Host Mask	Set the netmask of the Host Eth port.
		Cfg Mask	Set the netmask of the CfgEth port.
		Mac address	Show the mac address.
		Profibus addr	Profibus node address (only Profibus models)
		SD Card	
		Format	Format the SD card Disk
		Info	Shows SD capacity, free and used space
		Statistics	Reset Statistics
REDS			
	Working		Force MSC 900 topology role to Working
	Protecting		Force MSC 900 topology role to Protecting
	Active		Force MSC 900 redundancy role to Active. This item is enabled only if the MSC 900 has redundancy role == StandBy
	Standby		Force MSC 900 redundancy role to Standby. This item is enabled only if the MSC 900 has redundancy role == Active
<b>Menu</b>	<b>Branch</b>	<b>Branch</b>	<b>Note</b>

## 3 USER INTERFACE

The MSC 900 Controller provides fully automated, industrial quality control for Leuze electronic omnidirectional barcode identification systems. The user interface provides an easy-to-use series of configuration and diagnostics features that enable you to set up your Scanning System.

### 3.1 GETTING STARTED

The **MSC 900 Controller** is designed for ease-of-setup. The **MSC 900 User Interface** is a browser-based application you will use to define operating parameters, monitor read quality, construct output messages, and view diagnostics. The User Interface enables you to easily configure, fine-tune, and monitor your scanning system operation.

This User Interface provides ease-of-use for any operator level.

#### 3.1.1 Prerequisites

Before setting up your barcode scanner you will need the following:

<b>Computer</b>	Laptop
<b>Browser</b>	Internet Explorer 11 (or later)
	Firefox 30 (or later)
	Chrome 36 (or later)
<b>Java</b>	Java version 8 (or later)



**NOTE:** If the Diagnostic | Monitor page does not run, you may need to create an exception in the Java Control Panel.

To do this:

If the Diagnostic | Monitor page does not run, you may need to create an exception in the Java Control Panel.

**To do this:**

3. Click the **Start/Home** button and type **Configure Java** in the search field. Select the **Java Control Panel** from the search results. The **Java Control Panel** opens.
4. Click the **Security Tab** to open it.
5. Under **Exception Site List**, click **Edit Site List...** The **Exception Site List** window opens.
6. Click **Add**.
7. Enter the IP Address for the system/scanner in the field provided as follows: `http://10.27.154.125/` (but matching your system's IP Address)
8. Click **OK**. The Monitor page should now load.

### 3.1.2 Starting the User Interface

#### To access the User Interface:

1. Connect your computer to the MSC 900 CFG port. If the CFG port is taken, HOST port can be used.
2. Turn on your computer.
3. If you are connecting to a stand-alone unit (not connected to an in-house network), you must configure your PC's IP Address to be in the same network as the IP Address.

#### To change your PC's IP Address:

- a. From the desktop, click the **Start** button, and then select **Control Panel**.
  - b. Type **adapter** in the search box, and then from the results, under **Network and Sharing Center**, click **View network connections**.
  - c. Right-click **Local Area Connection**, and then select **Properties**.
  - d. Select the **Networking** tab. Under **This connection uses the following items**, click **Internet Protocol Version 4 (TCP/IPv4)**, and then click **Properties**.
  - e. Select **Use the following IP address**.
  - f. In the **IP address** field, type the first 3 octets of the IP address of the reader/controller unit.
  - g. For the last octet, type a number that differs from the last octet in the reader/controller's IP address. The actual number used is not important as long as it does not match that of the reader/controller.  
  
**Example:** If the barcode scanner's IP Address is 192.168.3.100, set your PC's IP Address to 192.168.3.101.
  - h. In the Subnet mask field, type 255.255.255.0
  - i. In the **Default gateway** field, type 0.0.0.0
  - j. Click **Okay**.
4. Open a web browser and enter the IP address for the MSC 900 Controller. If the correct IP address is entered, the MSC 900 User Interface Log On window will appear.

The default setup IP address for all **MSC 900 Controllers** is: 192.168.3.100 (CFG) and 172.27.101.220 (Host).

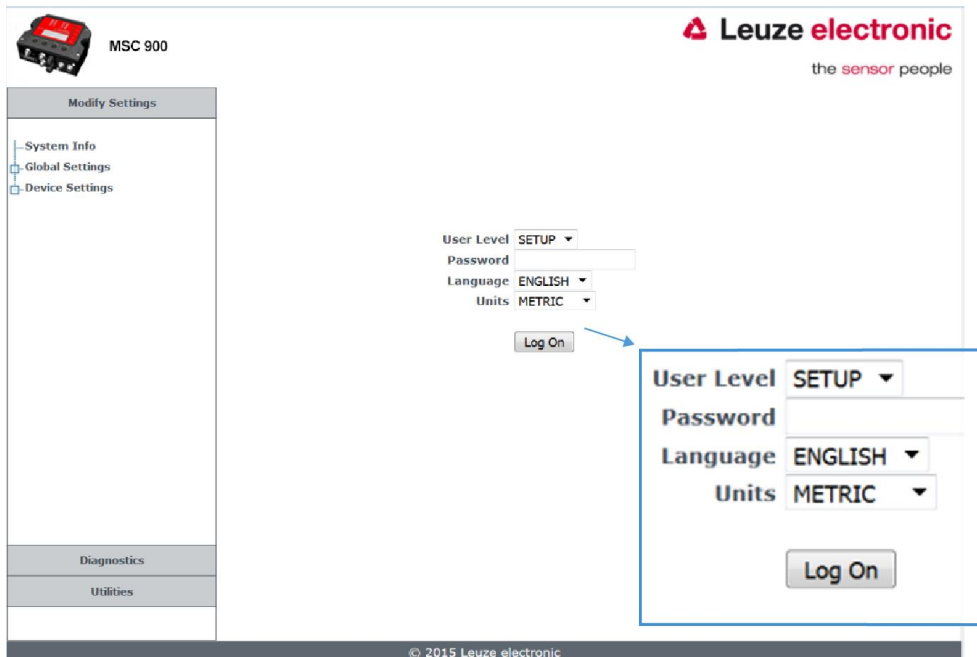

5. Enter the **Password** (default is LEUZE) for your system in the fields provided.
6. Select a language from those available in the **Language** drop-down list.
7. Select **METRIC** or **IMPERIAL** from the **Units** drop-down list.
8. Click **Log On**.

If the password is valid, the application enables all functions available to the user and displays the main window.

If the password is not valid, the application displays a results box with the message, **“Incorrect Password.”** Click **OK** to return to the **Log On** window and enter the correct user name and password. If you don't know the password, query your system manager.

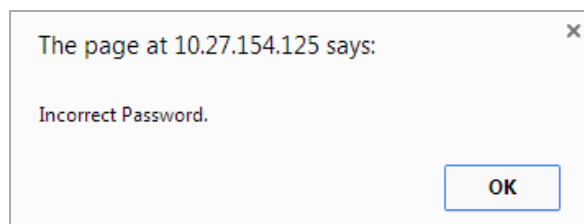

### To log out of the User Interface:

Click  at the upper right corner of the User Interface window to Log Out. When logged out, the Log On window will appear.

## 3.2 USER INTERFACE BASICS

### 3.2.1 MSC 900 User Interface Menu Tree

The functions that you can select are displayed in a menu tree on the left-hand side of the reader/controller User Interface. The function list is organized much like the hierarchy of a file system, where you can expand items that are preceded by a box (☐) to further sub-levels until you find a function of interest.

Sub-levels appear indented below the items from which they are expanded. Clicking the box again will collapse that branch of the menu. You can expand no further when an item is not preceded by a box.

The reader/controller User Interface menu tree appears with no items expanded. Click the folders to display the active window for the setup function and/or expand the folders to view any additional setup features.

### 3.2.2 Entering Text Using the Text Entry Tool

In cases where text needs to be entered to create message headers, trailer, custom messages, or for other reasons, the **Text Entry Tool** pencil icon “✎” will be displayed.

Click ✎ to open the **Text Entry Tool**.

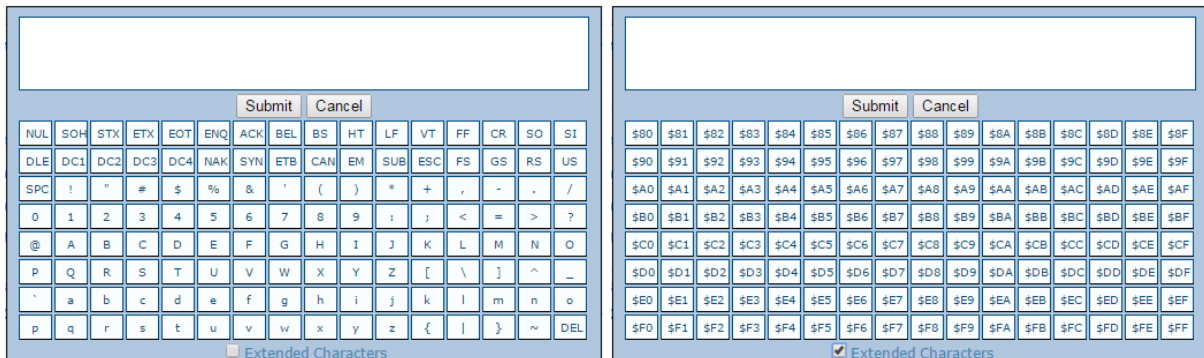

**NOTE:** The **Text Entry Tool** is needed to enter unprintable/untypable characters. For example, <CR> is a single character presented as a string for more easily reading.

The character must be entered with the tool, if typed normally it will be recognized as a string and not as a single character.

You can enter text in the text field by typing, or click on the character buttons to create your message. Select the **Extended Characters** check box to reveal a new set of control characters.

Click **Submit** to save your text to the origin window text field, or click **Cancel** to return to origin window without transferring text.

### 3.2.3 Getting Help

The complete help for the **MSC 900 User Interface** is available in this manual.

**To access the complete help system:**

Select **Utilities | Help** in the User Interface menu tree.



### 3.3 MODIFY SETTINGS

Use the Modify Settings Menu Tree selections during initial setup to configure your scanning system. If necessary, you can later make modifications to the configuration using the same menu selections.

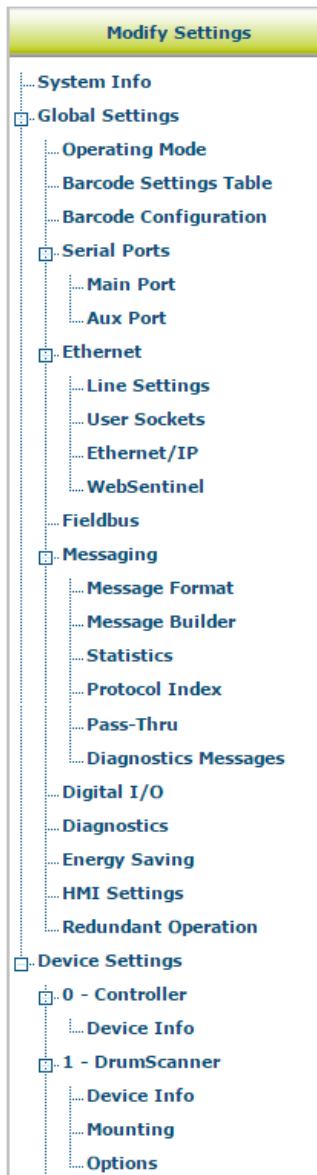

### 3.4 MODIFY SETTINGS | SYSTEM INFO

Use **System Info** to identify and name the scanning system (whether it includes one scanner or an array), indicate Master or Standalone systems, discover the scanners included in the system, and distribute software from the Master scanner to Slave scanners in the system.

**To view and edit system information:**

1. In the tree menu under **Modify Settings**, click System Info. The System Info window opens.

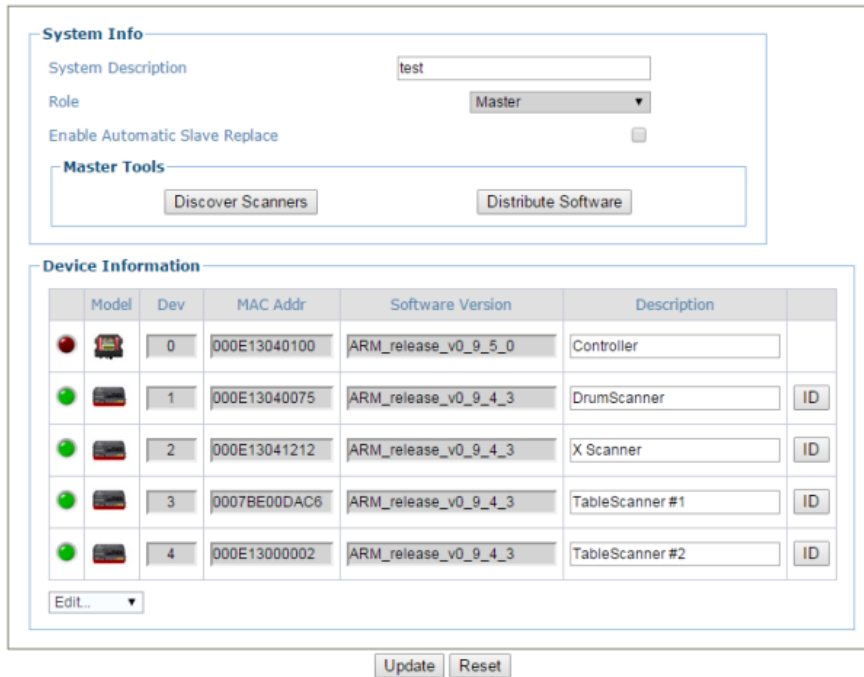

2. Enter the appropriate information in the form as described below:











Field Name	Action/Definition
<b>System Info</b>	
<b>System Description</b>	Enter a name to identify this scanning system in the text field.
<b>Role</b>	Select <b>Standalone</b> or <b>Master</b> from the drop-down list. <b>Standalone</b> (not controllers) indicates a scan point with a single barcode scanner. <b>Master</b> indicates that the system is made up of more than one barcode scanner in a master and slave configuration.
 <b>NOTE:</b> The MSC 900 Controller will always be shown as <b>Master</b> and cannot be changed.	
<b>Enable Automatic Slave Replace</b>	There are two way to replace a defective scanner : <ul style="list-style-type: none"> <li>• If the checkbox <b>is not</b> selected: The replacement will be done only pressing the RESTORE (see <i>the scanner's Reference Manual</i>) key on the scanner or using the <b>Edit</b> drop-down.</li> <li>• If the checkbox <b>is</b> selected: The replacement will be completely automatic. This will work also as Hot-Automatic-Replacement without turning the system power off and on.</li> </ul>

## Master Tools

### Discover Scanners

Click **Discover Scanners** to automatically find all of the scanners in an array. The discovered scanners will be listed in the **Device Information** portion of the window. This step is only done during initial configuration and is not a troubleshooting option.

**Device Information**

Model	Dev	MAC Addr	Software Version	Description	
 	0	000E13040100	ARM_release_v0_9_5_0	Controller	
 	1	000E13040075	ARM_release_v0_9_4_3	DrumScanner	ID
 	2	000E13041212	ARM_release_v0_9_4_3	X Scanner	ID
 	3	0007BE00DAC6	ARM_release_v0_9_4_3	TableScanner #1	ID
 	4	000E13000002	ARM_release_v0_9_4_3	TableScanner #2	ID

Edit... ▼

### Distribute Software

Click **Distribute Software** to send the current software residing on the master scanner to all of the slave scanners listed in the **Device Information** section of the window.

## Device Information

### Status

**Green** = No errors and ready to read

**Gray** = Unit not connected (unit not seen by master)

**Red** = Error. If you click on the red circle it will take you to the status viewer page for more info on the error

### Model

Displays an image of the scanner/controller model

### Dev

Displays the system designation for the device

### MAC Address

Displays the MAC Address (Media Access Control Address) for the device

### Software version

Displays the device installed software version.

### Description

Enter a user-defined description of the device.

### ID

Click ID to visually identify a scanner in an array/tunnel. When clicked, all the scanner lasers will turn off except for the selected scanner, whose laser will blink for 20 seconds.

**Edit**

Select to **Remove, Reassign, Add, or Replace** from the **Edit** drop-down list to complete the following actions:

- **Remove:** When selected, you can select the scanner to remove from the Dev/MAC Address drop-down list. Click **OK** to remove the selected scanner from the system.
- **Reassign:** When selected, the Dev column of the selected slave scanner (selected with ID) presents a drop-down list of Dev numbers. Select a different number to reassign the scanner.
- **Add:** This is an option under the **Edit** drop-down list in the **Unconfigured Devices** section of the screen. Click **OK** to add the selected device to the system.
- **Replace:** This is an option under the **Edit** drop-down list in the **Unconfigured Devices** section of the screen. When selected, you can select from a list of slave scanners (*Those with a gray indicator, meaning the unit is not connected*) in the system using **MAC Address** and **Dev** drop-down lists. Click **OK** to replace the selected scanner with the **Unconfigured Device**.

	MAC Addr	Model
1	000E1304FF16	BCL 900

Replace ▼ 000E1304FF16 ▼ 1 ▼ Ok

3. When you have finished making changes, click **Update** to save or click **Reset** to revert to the previously saved values.

### 3.5 MODIFY SETTINGS | GLOBAL SETTINGS

Use the Global Settings menu tree selections during initial setup to configure your **MSC 900** and its barcode scanning system. Global settings are applied to the system Master, and then distributed by the Master Scanner to the Slave devices. If necessary, you can later make modifications to the global system settings using the same menu selections.

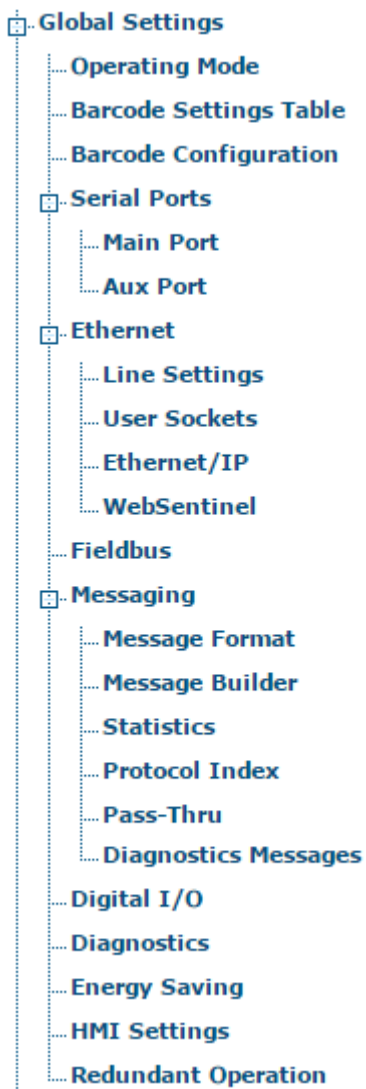

### 3.5.1 Modify Settings | Global Settings | Operating Mode

Use Operating Mode to select an operating mode and configure that modes related parameters. The three operating modes available are **On Line**, **Continuous**, and **PackTrack**, and the available settings differ depending on the operating mode selected.

**To edit the system Operating Mode:**

1. In the tree menu under **Modify Settings**, navigate to **Global Settings | Operating Mode**. The Operating Mode window opens.

**Operating Mode**

Operating Mode Selection Packtrack ▼

Bidirectional PackTrack Enable

**Trigger Source**

Start Input Number Trigger (Input 1) ▼

Start Input Active Level Active Closed ▼

Transmission Edge Trailing ▼

**Bidirectional PackTrack Settings**

Reverse Start Input Aux (Input 3) ▼

Reverse Start Input Active Level Active Closed ▼

Distance from PS to Reverse PS  mm

Direction Input I/O 4 (Input 4) ▼

Direction Input Active Level Active Closed ▼

**Mode Settings**

Distance from PS Line to Tx Line  mm

PS Line  mm

Minimum Package Length  mm

Minimum Distance Error Behavior Compose ▼

Minimum Distance Between Packages  mm

Window Dimension  mm

**Encoder Settings**

Physical Encoder Enable ▼

Encoder Step (hundredths of millimeter)

**Beam Shutter Settings**

Beam Shutter Disabled ▼

Update
Reset

2. Enter the appropriate information in the form as described below:

**Operating Mode** Select **On Line**, **Continuous**, or **PackTrack** from the Operating Mode Selection drop-down list.

**Bidirectional PackTrack Enable (MSC 900 Only)** Select the check box to enable. If enabled, conveyor direction parameters are made available (forward or reverse).

Example:

- **Start Input Number**= Input 1
- **Reverse Start Input** = Input 3
- **Direction Input** = Input 4
- **Reverse Start Input Active Level** = Closed with reverse conveyor direction /Open with forward conveyor direction

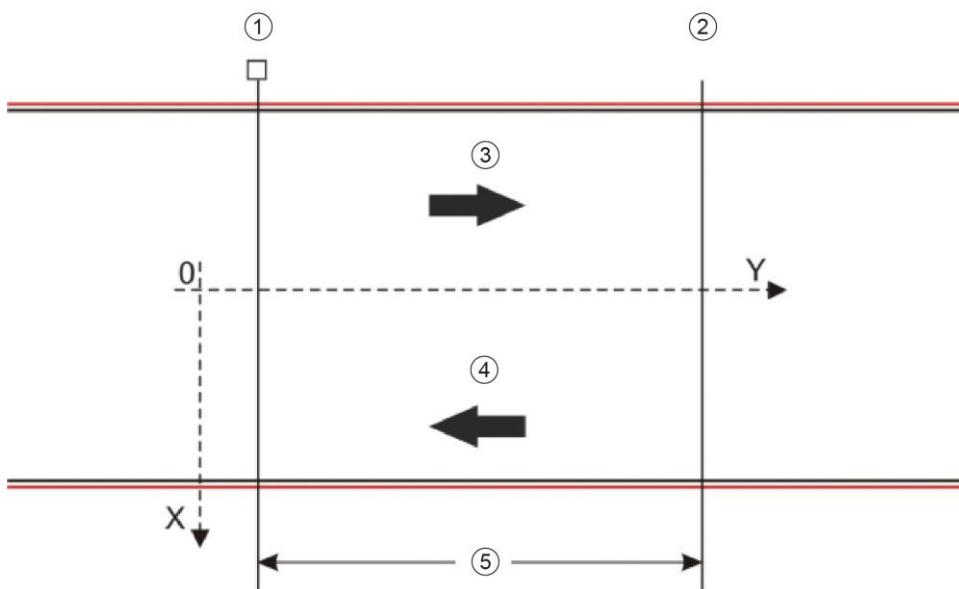

- ① PS (Input 1)
- ② Reverse PS (Input 3)
- ③ Conveyor Forward Direction
- ④ Conveyor Reverse Direction
- ⑤ Distance from PS to Reverse PS

#### Bidirectional PackTrack Settings

**Reverse Start Input** Select **Trigger (Input 1)**, **Aux (Input 3)**, or **I/O 4 (Input 4)** from the drop-down list. This defines the number of the input transmitting information about the conveyor current direction.

**Reverse Start Input Active Level** Select **Active Closed** or **Active Open** from the drop-down list. This defines the logical level of the input indicating the reverse direction of the conveyor.

**Distance from PS to Reverse PS** Enter a value to define the distance (mm [in]) between the PS (conveyor with forward direction) and the Reverse PS (conveyor with reverse direction).

**Direction Input** Select **Trigger (Input 1)**, **Aux (Input 3)**, or **I/O 4 (Input 4)** from the drop-down list. This defines the number of the input to be used as presence sensor when the conveyor has a reverse direction.

**Direction** Select Active Closed or Active Open from the drop-down list. This defines the active state of the Reverse Presence Sensor Input.

**Input Active Level**

- **Active Closed:** The input is active when there is no current flowing through IN pins
- **Active Open:** The input is active when current flows through IN pins

**Online** Select **1 Input Used**, **2 Inputs Used**, or **Serial** from the **On Line Options** drop-down list. Each selection has a different set of parameters as described below. In this operating mode, the reading phase is defined as the time between the **Phase ON** and **Phase OFF** events. The Phase events can be signals coming from one or two external presence sensors connected to the scanner inputs or serial start/stop strings sent from the host over the serial interface or Ethernet input.

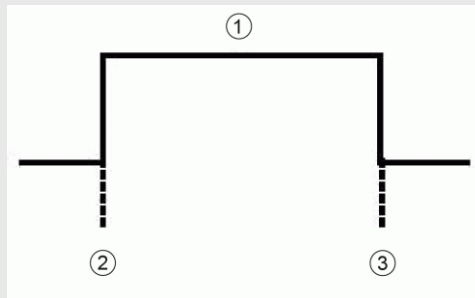

- ① Reading Phase
- ② External Trigger active
- ③ External Trigger inactive

**1 Input Used** The reading phase takes place during the active phase of the presence sensor, when the scanner tries to acquire and correctly decode the code. If the operation is successful, the barcode characters are transmitted on the serial interface or Ethernet input in the format defined by the current configuration and the right output event is raised at the end of the photoelectric sensor's active phase. If a code cannot be decoded, a no read message is sent and the no read event is raised at the end of the photoelectric sensor's active phase.

**Trigger Source**

**Start Input Number** Select the Input Number from the selections available in the drop-down list.

This option defines the numbered input that will start the trigger cycle.



**Start Input Active Level** Select **Active Open** or **Active Closed** from the drop-down list.

- **Active Open:** The input is active when there is no current flowing through IN pins. The input from the trigger source is normally closed. The scanner goes into trigger mode when the input source is opened.
- **Active Closed:** The input is active when current flows through IN pins. The input from the trigger source is normally opened. The scanner goes into trigger mode when the input source is closed.

**Reading Phase Timeout** Select the check box to define a timeout for the On Line Serial mode and the On Line 1 Input mode.

**Timeout (ms)** Enter a timeout in milliseconds (from 40 to 15000 ms) in the field provided. The **Timeout** represents the period of time for the reading phase.

**Timeout Counting From** Select **Start** or **Stop** from the drop-down list.

- When **Start** is selected, the **Timeout** used to determine the reading phase will begin from the **Start Input** or **Serial Start String** (normal operation)
- When **Stop** is selected, the **Timeout** used to determine the reading phase will begin from the **Stop Input** or **Serial Stop String** (effectively extending the reading phase).

### Verifier Settings

**Verifier Enable** Select the check box to enable the **Code Verifier** operating mode.

**Verifier Code** Click  to activate the Text Entry Tool and create the string text used as the match code to the decoded codes. Use characters from **NUL** (00H) to ~ (7EH). Click **Submit** to save your text to the origin window text field, or click **Cancel** to return to origin window without transferring text.

**Store Input** Select an option from the drop-down list to define the number of the input used to automatically store the verifier code. This input must be activated before the reading phase starts, the verifier code must be read and then after the end of the reading phase the input must be deactivated.

**Active Level** Select **Active Open** or **Active Closed** from the drop-down list to choose the active state of the input.

- **Active Open:** The input is active when there is no current flowing through IN pins. The input from the verify mode source is normally closed. The scanner goes into trigger mode when the input source is opened.
- **Active Closed:** The input is active when current flows through IN pins. The input from the verify mode source is normally opened. The scanner goes into trigger mode when the input source is closed.

---

**Wrong Code Tx** Select the check box to enable the transmission of the Wrong Code (Non-Valid Code).

---

**Wrong String Tx** Select the check box to enable the transmission of the Wrong String (Non-Valid String) message.

---

**Wrong String (max. 128 chars)** Enter a text string to be sent in case of a mismatch (wrong code read/non-valid code).

---

**Beam Shutter Settings**

---

**Beam Shutter** Select **Disabled**, **Triggered**, or **Enabled** from the drop-down list. The Beam Shutter turns the laser off. The Beam Shutter option can be used to increase the overall laser diode life when used in high ambient temperature applications (over 35° C); reduce power consumption; and to turn off the laser for safety purposes.

- **Disabled:** The laser is always on.
- **Triggered:** The laser is turned off as soon as the code(s) are read or when the reading phase ends. The laser is turned on again when the next reading phase starts.
- **Enabled:** The laser is always off and all operations are suspended.

**2 Inputs Used** The reading phase is defined by 2 inputs. It starts when the **Start Input** is activated and stops when the **Stop Input** is deactivated (unless the **Extended Phase** is enabled).

---

**Trigger Source**

---

**Extended Phase** Available only for the **On Line/2 Inputs** option. If checked, it allows the **Stop Input** to end the reading phase only if the **Start Input** is also deactivated.

---

<b>Start Input Number</b>	Select an input from the drop-down list to define the number of the input starting the reading phase.
<b>Start Input Active Level</b>	Select <b>Active Open</b> or <b>Active Closed</b> from the drop-down list. <ul style="list-style-type: none"> <li>• <b>Active Open:</b> The input is active when there is no current flowing through IN pins. The input from the trigger source is normally closed. The scanner goes into trigger mode when the input source is opened.</li> <li>• <b>Active Closed:</b> The input is active when current flows through IN pins. The input from the trigger source is normally opened. The scanner goes into trigger mode when the input source is closed.</li> </ul>
<b>Stop Input Number</b>	Select an input from the drop-down list to define the input ending the reading phase.
<b>Stop Input Active Level</b>	Select <b>Active Open</b> or <b>Active Closed</b> from the drop-down list to define the active state of the input. <ul style="list-style-type: none"> <li>• <b>Active Open:</b> The input is active when there is no current flowing through IN pins. The input from the trigger source is normally closed. The scanner goes into trigger mode when the input source is opened.</li> <li>• <b>Active Closed:</b> The input is active when current flows through IN pins. The input from the trigger source is normally opened. The scanner goes into trigger mode when the input source is closed.</li> </ul>
<b>Reading Phase Timeout</b>	If checked, it allows defining a timeout for the Serial On Line mode and the On Line 1 Input mode.
<b>Stop Phase Edge</b>	Select Trailing or Leading from the drop-down list to define the signal edge of the stop input used by the scanner as reference for ending the reading phase: <ul style="list-style-type: none"> <li>• <b>Trailing:</b> The reading phase ends when the pack has completely passed by the stop input.</li> <li>• <b>Leading:</b> The reading phase ends as soon as the stop input detects the front edge of the package.</li> </ul>

**Beam Shutter Settings**

**Beam Shutter** Select Disabled, Enabled, or Triggered from the drop-down list. The Beam Shutter turns the laser off and can be used:

- to increase the overall laser diode life when used in high ambient temperature applications (over 35° C);
- to reduce power consumption;
- to turn off the laser for safety purposes.

**Selection definition:**

- **Disabled:** The laser is always on.
- **Enabled:** The laser is always off and all operations are suspended.
- **Triggered:** The laser is turned off as soon as the barcode(s) are read or when the reading phase ends. The laser is turned on again when the next reading phase starts

**Serial** In **Serial/On-Line** mode the reading phase starts when the **Serial Start String** is received on the serial interface and ends when the **Serial Stop String** is received or when a programmed **Reading Phase Timeout** expires.

If decoding is correct, the data is transmitted on the serial port as defined by the configuration. The output line selected for the right output event is activated and the relative message is transmitted on the serial interface or Ethernet input.

In case of a bad read, a no read message is transmitted on the serial interface. The output line selected for the no read event is activated and the relative message is transmitted on the serial interface or Ethernet input.

**Trigger Source**

**Serial Start String (max. 32 chars)** Click  to activate the **Text Entry Tool** and create the string text used to signal the beginning of the reading phase. Use characters from NUL (00H) to ~ (7EH). Click **Submit** to save your text to the origin window text field, or click **Cancel** to return to origin window without transferring text.

The **Serial Start** string must be different from the **Serial Stop** string and **Motor ON/OFF** strings. When **ACK/NAK Protocol** or **Energy Saving** is enabled, the **Serial Start/Stop Strings** cannot contain ACK/NAK characters.

**Serial Stop String (max. 32 chars)**

Click  to activate the **Text Entry Tool** and create the string text used to signal the end of the reading phase. Use characters from NUL (00H) to ~ (7EH). Click **Submit** to save your text to the origin window text field, or click **Cancel** to return to origin window without transferring text.

The **Serial Stop** string must be different from the **Serial Start** string and **Motor ON/OFF** strings. When **ACK/NAK Protocol** or **Energy Saving** is enabled, the **Serial Start/Stop Strings** cannot contain ACK/NAK characters.

---

<b>Reading Phase Timeout</b>	Select the check box to define a timeout for the <b>Serial On Line mode</b> .
------------------------------	---

---

<b>Timeout (ms)</b>	Enter a timeout in milliseconds (from 40 to 15000 ms) in the field provided. The <b>Timeout</b> represents the period of time for the reading phase.
---------------------	--

---

<b>Timeout Counting From</b>	Select <b>Start</b> or <b>Stop</b> from the drop-down list. <ul style="list-style-type: none"> <li>• When <b>Start</b> is selected, the <b>Timeout</b> used to determine the reading phase will begin from the <b>Start Input</b> or <b>Serial Start String</b> (normal operation)</li> <li>• When <b>Stop</b> is selected, the <b>Timeout</b> used to determine the reading phase will begin from the <b>Stop Input</b> or <b>Serial Stop String</b> (effectively extending the reading phase).</li> </ul>
------------------------------	---

---

<b>Stop Priority</b>	This is available when <b>Start</b> is selected from the <b>Timeout Counting From</b> drop-down list. <p>Select <b>Input/Serial Stop</b> or <b>Always Timeout</b> from the drop-down list.</p> <ul style="list-style-type: none"> <li>• <b>Input/Serial Stop:</b> The Stop Input Number or Serial Stop String defines the end of the reading phase. Timeout has a lower priority.</li> <li>• <b>Always Timeout:</b> The reading phase always stops when the selected timeout expires.</li> </ul>
----------------------	--

---

**Beam Shutter Settings**

**Beam Shutter** Select **Disabled**, **Enabled**, or **Triggered** from the drop-down list. The **Beam Shutter** turns the laser off and can be used:

- to increase the overall laser diode life when used in high ambient temperature applications (over 35° C);
- to reduce power consumption;
- to turn off the laser for safety purposes.

**Selection definition:**

- **Disabled:** The laser is always on.
- **Enabled:** The laser is always off and all operations are suspended.
- **Triggered:** The laser is turned off as soon as the code(s) are read or when the reading phase ends. The laser is turned on again when the next reading phase starts

**Continuous** The reading phase is always active and allows reading two or more codes when placed along the same scan line. Code transmission is identical to the other operating modes except that there is no transmission on the serial port in case of a No Read condition.

**Mode Setting**

**Code Filter** Select **Disable**, **Timeout**, **Encoder Steps**, or **Tx Line** from the **On Line Options** drop-down list. This parameter determines criteria for flushing entries from the code filtering list depending on the type of list management:

- The **Code Filter Depth** parameter, when not = 0, manages a FIFO (First In First Out) list of codes which are compared for filtering. The **Timeout** and **Encoder Steps** values are in addition to the cyclical flushing of entries when the FIFO list depth is exceeded.
- When **Code Filter** is set to **Tx Line** an internal list is managed where each entry is flushed when the **Tx Line** distance is exceeded.

The application program inherently compares codes based on content and code length.

Each Code Filter criteria has its own relative value parameter.

- **Disable:** No additional criteria are applied. If code filtering is enabled through the Code Filter Depth parameter, the FIFO list is only modified by new code entries (FIFO list depth exceeded).
- **Timeout:** A timeout measured in milliseconds is also applied to each code entry. The current code entry will be flushed from the list when the timeout expires.
- **Encoder Steps:** a threshold measured in encoder steps is also applied to each code entry. The current code entry will be flushed from the list when the number of encoder steps is exceeded. See Filter Number of Encoder Steps.
- **Tx Line:** The distance measured in mm to the transmit line is applied to each code entry. The current code entry will be flushed from the list when the distance in mm is exceeded. When Tx Line is selected, all the networked scanners must have been calibrated using PackTrack (See *PackTrack in the BCL 900i Reference Manual*).



**NOTE:** When Code Filter = Tx Line:

The Code Filter Depth parameter is no longer available because the application program manages an internal list which depends solely on the number of codes decoded before the Tx Line is reached.

Any code which is determined to be identical to a code in the list by comparing the filter conditions will be discarded, and to increase precision the code in the list will have its x, y, z position coordinates adjusted as the average between the two readings.

$$x=x_1+x_2/2, \quad y=y_1+y_2/2, \quad z=z_1+z_2/2$$

---

<b>Use Encoder</b>	Select the check box to activate the encoder settings.
--------------------	--

---

**Code Filter Depth** In **Continuous mode**, **Code Filter Depth** is used to avoid multiple reads of the same code. The entered value (other than zero) defines the number of codes to memorize in a FIFO (First In First Out) list.

When a code is read, it is compared to the list. The application program inherently compares codes based on content and code length. If the list contains a code identical to the current code being read, the current code is discarded. If not, the current code is accepted and added to the list in the first position; the remaining codes in the list are shifted. If the list is full the oldest code in the list will be flushed.

When = 0, there is no FIFO list and there is no filtering.

Selection: a value from 0 to 127

**Example:**

Code Filter Depth = 3

List	Code Read
xxx (no codes in list)	A
Axx	B
BAx	B
BAx	C
CBA	D
DCB	A
ADC	A

---

**Filter Number of Encoder Steps** Enter a number of encoder steps from 1 to 15000. This parameter sets the number of Encoder Steps after which the **FIFO (First In First Out)** list entry is flushed.

---

**Filter Timeout Value (ms)** Enter a timeout value in milliseconds in the field provided. A value between 40 and 15000ms may be used. This value sets the time limit after which the **FIFO (First In First Out)** list entry is flushed.

---

**Replicate same code when symbologies don't match** Select the check box to enable a further code filter condition according to which a read code is added to the list or discarded. This parameter is available if the **Code Filter Depth** value is other than zero or if the Code Filter value is Tx Line.

In addition to the inherent content and code length comparison, this parameter compares the code type (symbology). If the current code being read is identical to any code contained in the list by: content, length and type, the current code is discarded. If not, the current code is accepted and added to the list in the first position; the remaining codes in the list are shifted. If the list is full the oldest code in the list will be flushed.



**Replicate same code when X positions don't match**

Select the check box to enable a further code filter condition according to which a read code is added to the list or discarded. This parameter is available if the **Code Filter Depth** value is other than zero or if the Code Filter value is Tx Line.

In addition to the inherent content and code length comparison, this parameter compares the X coordinate code position. If the current code being read is identical to any code contained in the list by: content, length and X coordinate code position, the current code is discarded. If not, the current code is accepted and added to the list in the first position; the remaining codes in the list are shifted. If the list is full the oldest code in the list will be flushed.

**Replicate same code when Y positions don't match**

Select the check box to enable a further code filter condition according to which a read code is added to the list or discarded. This parameter is available if the Code Filter **Depth** value is other than zero or if the Code Filter value is Tx Line.

In addition to the inherent content and code length comparison, this parameter compares the Y coordinate code position. If the current code being read is identical to any code contained in the list by: content, length and Y coordinate code position, the current code is discarded. If not, the current code is accepted and added to the list in the first position; the remaining codes in the list are shifted. If the list is full the oldest code in the list will be flushed.

**Replicate same code when Z positions don't match**

Select the check box to enable a further code filter condition according to which a read code is added to the list or discarded. This parameter is available if the **Code Filter Depth** value is other than zero or if the Code Filter value is Tx Line

In addition to the inherent content and code length comparison, this parameter compares the Z coordinate code position. If the current code being read is identical to any code contained in the list by: content, length and Z coordinate code position, the current code is discarded. If not, the current code is accepted and added to the list in the first position; the remaining codes in the list are shifted. If the list is full the oldest code in the list will be flushed.

**Continuous Threshold (number of scans)**

Enter an *N* number of scans without a code allowed in order to assure code identification in the reading zone. Enter a value from 10 to 32665.

**Encoder Settings****Physical Encoder**

Select **Disable** or **Enable** from the drop-down list:

- **Disable:** No encoder is enabled
- **Enable:** A physical encoder is connected to the Encoder input and is enabled

**Encoder Step** Enter the step value of the encoder.

**Encoder Step Settings Table:**

Encoder Model	PPR ( Pulses Per Revolution)	PPI ( Pulses Per Inch)	Encoder Step Setting
OEK-4	250	20	63
OEK-2	24	2	635
OEK-2	48	4	317
OEK-2	192	16	79
OEK-2	240	20	63

**Conveyor Speed (mm/sec)** This parameter is available only when the Physical Encoder is disabled. It defines the constant speed of the conveyor in mm/sec.

**PackTrack** Refer to *PackTrack in the BCL 900i Reference Manual* for physical PackTrack installation procedures.

**Trigger Source**

**Start Input Number** Select an input from the drop-down list to define the number of the input starting the reading phase.

**Start Input Active Level** Select **Active Open** or **Active Closed** from the drop-down list to define the active state of the input.

- **Active Open:** The input is active when there is no current flowing through IN pins.
- **Active Closed:** The input is active when current flows through IN pins.

**Transmission Edge** Select **Trailing** or **Leading** from the drop-down list to define the signal edge of the stop input used by the scanner as reference for ending the reading phase:

- **Trailing:** The reading phase ends when the pack has completely passed by the stop input.
- **Leading:** The reading phase ends as soon as the stop input detects the front edge of the pack.

### Mode Setting

#### Distance from PS Line to Tx Line

Enter the distance along the Y axis from the PS (photoelectric sensor) to the TX Line (transmit).

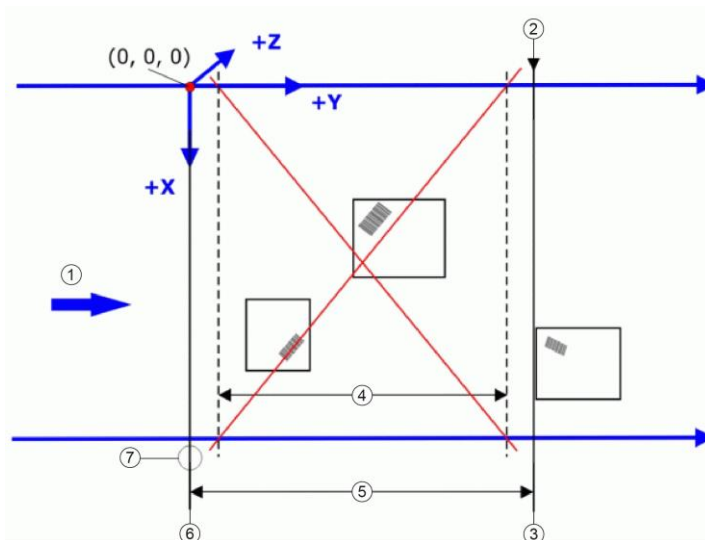

- ① Conveyor Direction
- ② End of Tracking Area
- ③ Tx Line
- ④ Reading Area
- ⑤ Tracking Area
- ⑥ PS Line
- ⑦ Photocell or equivalent signal



**NOTE:** Tracking starts 10 cm [4 inches] before and stops 10 cm [4 inches] after the Reading Area in order to ensure the barcode is assigned to the correct package.

**PS Line** This parameter defines the read signal Y coordinate (mm) referred to the origin of co-ordinates used for PackTrack™ configuration (see below).

**Example:**

Normally the PS Line coincides with the PackTrack reference where X, Y, Z = 0.

If the presence sensor (photocell or Host PS signal) is moved, you must set the PS Line accordingly and recalculate the Tx Line.

1. PS Line = 0; Distance from PS Line to Tx Line = 2500
2. PS Line = 500; Distance from PS Line to Tx Line = 2000

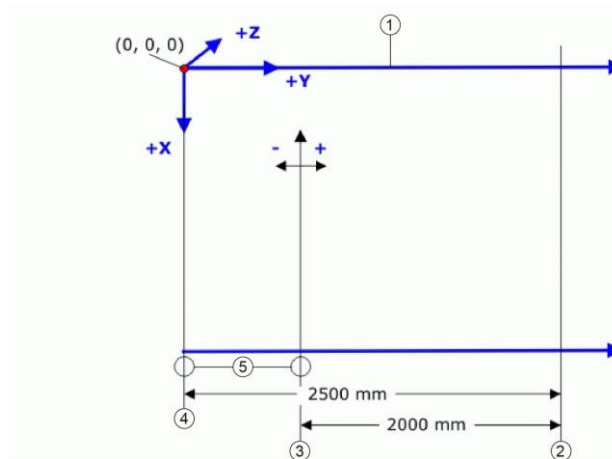

- ① Conveyor Direction
- ② Tx Line
- ③ new PS Line = 500 mm
- ④ original PS Line = 0
- ⑤ Photocell

---

**Minimum Pack Length** Enter the minimum length of a pack in the space provided (mm, in).

---

**Minimum Distance Error Behavior** Select **Ignore Error**, **Compose**, or **Discard Last** from the drop-down list.

- **Ignore Error:** the occurred error is ignored
- **Compose:** Enter the Minimum Distance Between Packs in the field provided.
- **Discard Last:** discards all received packs

---

**Minimum Distance Between Packages** Enter the minimum distance (mm, in) between consecutive packs. This field is only available when **Compose** or **Discard Last** is selected for the **Minimum Distance Error Behavior**.

---

**Window Dimension** Enter a **Window Dimension** in the field provided.

The measurement of a barcode position in absolute coordinates performed by the scanners may be affected by an error. PackTrack™ evaluation can fail in assigning the barcode for this reason. With the **Window Dimension** parameter, the Y coordinates that delimit the pack can be virtually extended to improve the assigning success rate (see the following figure).

If the minimum distance between two consecutive packs is less than twice the value of the **Window Dimension**, the window is dynamically resized (dynamic window) to half the distance between the two packs. The code will be assigned within the **Window Dimension** of the closest pack.

If the minimum distance between two consecutive packs is more than twice the value of the **Window Dimension**, the code will be assigned within the **Window Dimension** itself.

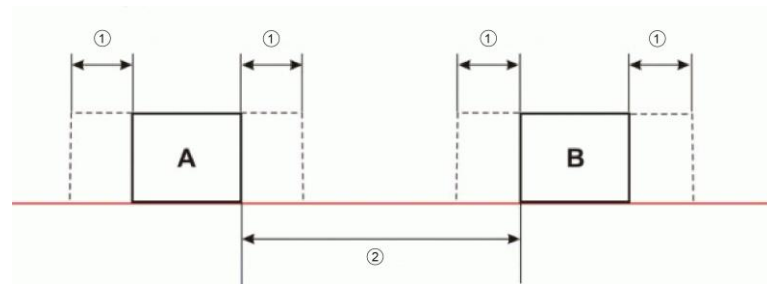

- ① Window Dimension  
② Min Distance Between Packs

### Encoder Settings

**Physical Encoder** Select **Disable** or **Enable** from the drop-down list:

- **Disable:** No encoder is enabled
- **Enable:** A physical encoder is connected to the Encoder input and is enabled

**Encoder Step (hundredths of millimeter)** Enter the step value of the encoder.

**Encoder Step Settings Table:**

Encoder Model	PPR (Pulses Per Revolution)	PPI (Pulses Per Inch)	Encoder Step Setting
OEK-4	250	20	63
OEK-2	24	2	635
OEK-2	48	4	317
OEK-2	192	16	79
OEK-2	240	20	63

**Conveyor Speed (mm/sec)** This parameter is available only when the **Physical Encoder** is **Disabled**. It defines the constant speed of the conveyor in mm/sec.

---

#### Beam Shutter Settings

---

**Beam Shutter** Select **Disabled**, **Enabled**, or **Triggered** from the drop-down list. The Beam Shutter turns the laser off and can be used:

- to increase the overall laser diode life when used in high ambient temperature applications (over 35° C);
- to reduce power consumption;
- to turn off the laser for safety purposes.

**Selection definition:**

- **Disabled:** The laser is always on.
- **Enabled:** The laser is always off and all operations are suspended.
- **Triggered:** The laser is turned off as soon as the code(s) are read or when the reading phase ends. The laser is turned on again when the next reading phase starts

---

**PackTrack Beam Shutter Timeout** Select a time value from the drop-down list. This parameter is available only when **Operating Mode = PackTrack™** and **Beam Shutter = Triggered**. By setting this parameter the laser is turned off as soon as the selected timeout expires.

---

3. When you have finished making changes, click **Update** to save or click **Reset** to revert to the previously saved values.

### 3.5.2 Modify Settings | Global Settings | Barcode Settings Table

Use **Barcode Settings** to select and configure barcodes to be read in your application. Each barcode type

To edit the **Barcode Settings**:

1. In the tree menu under Modify Settings, navigate to **Global Settings | Barcode Settings**. The Barcode Settings window opens.

2. Enter the appropriate information in the form as described below:

Field Name	Action/Definition
<b>Top Panel</b>	Displays a list of barcodes that have been added to the system with the following columns:
<b>Idx</b>	Select an option button for the row/barcode you wish to edit. <ul style="list-style-type: none"> <li>• If a barcode type is displayed in the selected row, its configuration can then be edited.</li> <li>• If a row displaying disabled is selected, a barcode type can be selected and configured for that row.</li> </ul>
<b>Symbology</b>	Displays the name of the barcode symbology for that row. If no symbology has been added for a row, disabled is displayed.
<b>Minimum Length</b>	Displays the minimum barcode character length for that row's symbology.

**Maximum Length** Displays the maximum barcode character length for that row's symbology.

**Barcode *n***



**NOTE:** Input fields will vary depending on the selected symbology.

**Enable** Select the **Enable** check box to activate the selected barcode. Deselect the **Enable** check box to disable the selected barcode. When the check box has been selected, configuration and code type options are displayed.

**Code Symbology** Select a barcode symbology from those available in the **Code Symbology** drop-down list.

**EAN Add On** Select **No Add On**, **2 digits Add On**, or **5 digit Add On** from the **EAN Add On** drop-down list. Selecting **2 digit Add On** or **5 digit Add On** adds that many digits as a supplement to the barcode. **EAN** is the acronym for **International Article Number**, previously known as **European Article Number**.

**Minimum Label Length** Enter the minimum character length for the selected barcode.

**Maximum Label Length** Enter the maximum character length for the selected barcode.

**Match String Rule** Select **Match** or **Do Not Match** from the drop-down list. This parameter defines the matching rule, according to which a code can be transmitted.

- Match: All codes matching the Pattern Match String will be transmitted
- Do Not Match: All codes not matching the Pattern Match String will be transmitted

**Pattern Match String (max. 200 chars)**

Click  to activate the Text Entry Tool and create a pattern match string. A code can also be identified by its content. A pattern matching string is programmable for each code and if the read codes do not match the defined string, a No Read Event will be returned.

It is possible to define the matching string by inserting:

- all printable characters
- non printable ASCII characters available in the list which appears by right-clicking on the parameter edit box
- \* = defining any string consisting of an undefined number of characters (it may be empty)
- ? = identifying any character to be found in the position indicated within the string

If your application requires inserting ?, \* and NUL as characters, it is necessary to use the following syntax:

- ? character = <NUL>?
- \* character = <NUL>\*
- NUL character = <NUL>00
- other extended ASCII characters = <NUL>xy, where xy identifies the character hex value



**Examples:****Match a code starting with 123 string and followed by any string of characters:**

- Match String = 123\*
- Example Code = 123aC53

**Match a code ending with 123 string preceded by any string of characters:**

- Match String = \*123
- Example Code = 41pO123

**Match a code having 123 string in any position:**

- Match String = \*123\*
- Example Code = 41pO123253

**Match a code starting with 123 string followed by three generic characters and an undefined string of characters, in this case no character:**

- Match String = 123???
- Example Code = 123ad2

**Match any code of four characters:**

- Match String = ????
- Example Code = gT6k

**Match a code with 6 characters in any position having 12 as central characters:**

- Match String = \*??12??\*
- Example Code = data12og35

**The following is an example of a very complex string where ? and\* are used both as commands and as characters:**

- Match String = \*45<NUL>??\*??AC<NUL>\*251?\*
- Example Code = GEN45?3iusdsAC\*2516300



**NOTE:** For **Codabar** codes the start/stop characters must be considered in the match conditions.  
For all codes which use check digits, if the **Check Digit** is transmitted, it must be considered in the match conditions.

**Options**

**NOTE:** Input fields will vary depending on the selected symbology.

**Decoding Safety**

Enter a number from **1** to **100** (**1** = control disabled) in the field provided. It verifies that an *N* number of decodes are performed with the same result before code reading is accepted as valid.

**Check Digit** Select the check box to improve decoding safety: it is generally the last digit aligned to the right of the code and verifies the validity of the preceding digits. The calculation technique and number of check digits depend on the code selected.

It is advised to enable the check digit whenever correct code identification is difficult. The following barcode symbologies include check digits in their definitions:

- Code 128
- EAN/UPC
- Code 93

For these symbologies the check digit control is not allowed.

---

**Check Digit Type** Select a customized check digit for **Standard, German, DHL, Daimler-Chrysler, or Bosch** from the drop-down list.

---

**Check Digit Tx** Select the check box to include the Check Digit in the code transmitted.

---

**Bar Count** Select **Variable** or an available value from the drop-down list. The Bar Count allows to further specify the number of elements in the read code for Code 128, GS1-128, Code 93, ISBT 128 or Code 39 Full ASCII.

For these codes, the same number of barcode elements (bars + spaces) can be associated with a different number of characters.

- **Variable:** to select the correct number of characters, set Label Length to the desired fixed value and Bar Count to Variable



12  
Code 128  
Subset A



12  
Code 128  
Subset C

Digit Number 2, Bar Count variable

- **Code 128 or GS1-128:** from 25 to 499 – a variable number of characters in steps of 6.
- **Code 93 or ISBT 128:** from 25 to 385 – a variable number of characters in steps of 6.
- **Code 39 Full ASCII:** from 29 to 619 – a variable number of characters in steps of 10.

To select a particular barcode length in elements, set Bar Count to the desired fixed value and Label Length to Variable.



12  
Code 128  
Subset A



1234  
Code 128  
Subset C

Digit Number variable, Bar Count 31

---

<b>Match Direction Rule</b>	<p>Select <b>Disable</b>, <b>Forward</b>, or <b>Reverse</b> from the drop-down list. This parameter defines the direction, according to which a code can be transmitted. The direction refers to the code direction with respect to the scan line, in particular: <b>Forward</b> = the code start character precedes the stop character in the scan line (Start Ch + Code + Stop Ch); <b>Reverse</b> = the code stop character precedes the start character in the scan line (Stop Ch + Code + Start Ch)</p> <ul style="list-style-type: none"><li>• <b>Disable:</b> All codes are transmitted no matter what the direction is</li><li>• <b>Forward:</b> All codes having a forward direction are transmitted</li><li>• <b>Reverse:</b> All codes having a reverse direction are transmitted</li></ul>
<b>Start Char Tx</b>	<p>Select <b>Disabled</b>, <b>Lower Case</b>, or <b>Upper Case</b> from the drop-down list. This parameter is available only for <b>Codabar</b> code symbologies. It allows transmitting the code start character:</p> <ul style="list-style-type: none"><li>• <b>Disabled:</b> The character is not selected;</li><li>• <b>Lower Case:</b> The character is transmitted in lower case;</li><li>• <b>Upper Case:</b> The character is transmitted in upper case.</li></ul>
<b>Stop Char Tx</b>	<p>Select <b>Disabled</b>, <b>Lower Case</b>, or <b>Upper Case</b> from the drop-down list. This parameter is available only for <b>Codabar</b> code symbologies. It allows transmitting the code stop character:</p> <ul style="list-style-type: none"><li>• <b>Disabled:</b> The character is not selected;</li><li>• <b>Lower Case:</b> The character is transmitted in lower case;</li><li>• <b>Upper Case:</b> The character is transmitted in upper case.</li></ul>

---

3. When you have finished making changes, click **Update** to save or click **Reset** to revert to the previously saved values.

### 3.5.3 Modify Settings | Global Settings | Barcode Configuration

Use **Barcode Configuration** to configure how the system defines a no read barcode, and configure and filter NOREAD messages.

**To edit the Barcode Configuration:**

1. In the tree menu under **Modify Settings**, navigate to **Global Settings | Barcode Configuration**. The **Barcode Configuration** window opens.

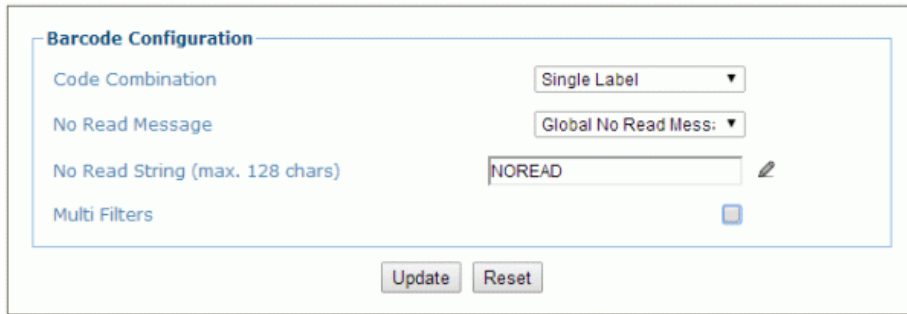

2. Enter the appropriate information in the form as described below:

Field Name	Action/Definition
------------	-------------------

<b>Code Combination</b>	Select <b>Single Label</b> , <b>Standard Multi Label</b> , <b>Logical Combination</b> , or <b>Code Collection</b> from the drop-down list. The Code Combination parameter selects the decoding mode for the scanner.
-------------------------	--

- **Single Label:** In this mode only one barcode can be read in each reading phase; however it can be determined automatically from up to 10 enabled codes. The scanner stops decoding as soon as a code is read.

If the code is not read during the reading phase, the No Read message is produced.

- **Standard Multi Label:** In Multi Label mode the barcodes selected (up to 10), will all be read in the same reading phase. If the reading phase terminates before all the codes are read, a Global No Read message will be produced, unless it is disabled, in which case a Local No Read will be produced.



**NOTE:** In case of Multi Label, the codes will be distinguished EITHER by their symbology, OR by their contents. If two (or more) codes share the same symbology and content, the scanner will perceive them as a unique code.

- **Logical Combination:** In Logical Combination mode the codes of the groups defined by the Logical Combination Rule are read in the same reading phase.
- **Code Collection:** In Code Collection mode expected codes are collected within a single reading phase in the order in which they are read. The No Read message is produced only if none of the codes are read. Up to 50 codes can be collected.

## Barcode Configuration > Single Label

When **Single Label** has been selected from the **Code Combination** drop-down list, the Barcode Configuration window reveals related input fields.

Enter the appropriate information in the form as described below:

Field Name	Action/Definition
<b>Code Combination</b>	<b>Single Label</b> has been selected.
<b>No Read Message</b>	<p>Select <b>Disable No Read Message</b>, <b>Global No Read Message</b>, or <b>Local No Read(s) Message</b> from the drop-down list. The No Read condition occurs whenever a code cannot be read or decoded.</p> <ul style="list-style-type: none"> <li>• <b>Disable No Read Message:</b> The No Read Message is not transmitted.</li> <li>• <b>Global No Read Message:</b> The No Read String will be sent if the scanner is unable to decode one or more barcodes in the reading phase.</li> <li>• <b>Local No Read(s) Message:</b> Do not use this option when working in Single Label mode.</li> </ul>
<b>No Read String (max. 128 chars)</b>	Click  to activate the Text Entry Tool and create a string to be displayed when <b>Global No Read Message</b> is selected from the <b>No Read Message</b> drop-down list.
<b>Multi Filters</b>	Select the check box to display the <b>Multi-Filter Settings</b> options.

### Multi-Filter Settings

**Contained Filter** Select the check box to reveal the **Max Number of Different Characters** field.

When checked, this filter attempts to eliminate false multiple reads by determining if a short code read is "contained in" (is a sub-string of), another longer code read. This condition implicates that the short code is probably a misread of the same longer code and therefore should be ignored, (should not be considered as a multiple read of a different code).

This filter is based upon the following rules:

- a multiple read condition occurs
- all decoded codes of the same type are compared with each other

**Rule 1:** the shorter code is considered contained in the longer code if the character string is found in the same order; the longer code may have a single block of characters in any position (before, after or in between the compared strings)

**Example:** The code **123456** is considered contained in the following codes:  
00**123456**, **123456**00, **12378456**.

The code **123456** is not considered contained in the following codes: 1234**6507** (string out of order), 12345**700** (string not complete), 12**0378**456 or **00**123456**00** (multiple blocks in the string).

**Rule 2:** the shorter code is not filtered by rule 1. In the longer code, all possible sub-strings of the same length as the shorter code string are compared with the shorter code string. The shorter code is considered contained in the longer code if the number of different characters between the compared codes is less than or equal to the Max Number of Different Characters. The shorter code will be filtered by rule 2.

**Example:**

If Max Number of Different Characters = 1:

The code **123456** is considered contained in the following codes: **123056**00, 00**123056**, 88**123056**88 because there is only one different character in the compared string.

The code **123456** is not considered contained in **123066**789 because there are two different characters in the compared string.



**CAUTION:** If the **Contained Filter** parameter is used when **Message Tx Selection** (see section 3.5.7) is set to **On Decoding**, the filter conditions may be satisfied before the reading phase ends resulting in possible successive multiple read errors.

**Max Number of Different Characters** Enter a value from 0 to 5 in the field provided to define the maximum number of different characters allowed to still consider a code as being included in another one and therefore to be filtered.

If the number of different characters between the compared codes exceeds the value of this parameter, the codes are considered as different and will not be filtered (a multiple read of a different code occurs).

If the number of different characters between the compared codes is less than or equal to the value of this parameter, the short code is considered as a sub-string of the longer code and will be filtered (no multiple read occurs).

**Examples:**

If Max Number of Different Characters = 2:

The code **123456** read once, is considered the same as the following codes read multiple times: **133056**, **123546**, **123457** because there are two or less different characters by position in the compared codes.

The code **123456** read once, is not considered the same as the following codes read multiple times: **153246**, **103057**, **654321** because there are at least three different characters by position in the compared codes.

---

**Voting Filter** Select the check box to reveal the **Max Number of Different Characters** field.

When checked, this filter attempts to eliminate false multiple reads by comparing the number of different characters by position between two codes of the same type and length. This condition implicates that reading a code of the same type and length having very few different characters is probably a misread of the code itself and therefore the code read the least number of times should be ignored, (should not be considered as a multiple read of a different code).

This filter is based upon the following rules:

- a multiple read condition occurs;
- the two codes are of the same type;
- the two codes have the same length;
- the number of different characters by position is equal to or less than the number defined by the Max Number of Different Characters parameter;
- **Message Tx Selection** (see section 3.5.7) must be set to **After Reading Phase Off**.

---

**Filter Out Low Height Codes** Select the check box to reveal the **Minimum Readings Difference Between Scanners** field.



**Background:** This option was developed for the airports systems where there are often tall bar height codes and low bar height codes with the same content attached to baggage. Travelers will often remove the large, tall bar height code, while leaving the smaller, low bar height codes attached to the bag. The next time they travel they may have multiple low bar height codes on their baggage plus the new tall bar height and low bar height codes for the new trip.

This option instructs the system to ignore low bar height codes, which are likely read only once or twice, in favor of tall bar height codes, which will likely be read multiple times.

This is used in tunnel applications where multiple barcodes are read and there is a need to filter out one of the barcodes. If less than *x* number of scanners read the barcode, then it will be considered a NOREAD for that code.

<b>Filter Out Single Readings</b>	If only 1 scanner reads a code it will be considered a NOREAD.
<b>Minimum Readings Difference Between Scanners</b>	Enter the minimum number of scanners that must read a barcode for it to be considered a valid read.
<b>Strip Filter</b>	Select the check box to display the <b>Strip Filter Settings</b> options. This is a second level filter that when enabled allows eliminating characters not managed by the host.

#### Strip Filter Settings

<b>Strip All Non Printable Chars</b>	Select the check box to remove all non- printable ASCII characters from the code (000-020 and 127).
<b>Char(s) to be Stripped</b>	Click  to activate the Text Entry Tool and enter specific characters to be stripped from the code. Click <b>Submit</b> to save your text to the origin window text field, or click <b>Cancel</b> to return to origin window without transferring text.
<b>Strip Filter Collapse</b>	Select the check box to remove the stripped characters from the code and, therefore, reduce the code length (collapsed). It can even be null.
<b>Replacement Char</b>	Click  to activate the Text Entry Tool and enter the substitution character to replace all the stripped ones. Click <b>Submit</b> to save your text to the origin window text field, or click <b>Cancel</b> to return to origin window without transferring text.

- When you have finished making changes, click **Update** to save or click **Reset** to revert to the previously saved values.



## Barcode Configuration > Standard Multi Label

When **Standard Multi Label** has been selected from the **Code Combination** drop-down list, the Barcode Configuration window reveals related input fields.

The screenshot shows the 'Barcode Configuration' window. At the top, 'Code Combination' is set to 'Standard Multi Label'. Below it, 'No Read Message' is set to 'Global No Read Mess:'. 'No Read String (max. 128 chars)' is set to 'NOREAD'. 'Multiple Read Message' and 'Send All Multiple Read Labels' are both set to 'Disable'. 'Web Sentinel - Partial Read Is Treated As' is set to 'Partial Read'. 'Multi Filters' is checked. The 'Multi-Filter Settings' section includes: 'Contained Filter' (checked), 'Max Number of Different Characters' (0), 'Voting Filter' (checked), 'Max Number of Different Characters' (2), 'Filter Out Low Height Codes' (checked), 'Minimum Readings Difference Between Scanners' (2), 'Filter Out Single Readings' (checked), and 'Strip Filter' (checked). The 'Strip Filter Settings' section includes: 'Strip All Non Printable Chars' (checked), 'Char(s) to be Stripped' (empty field), and 'Strip Filter Collapse' (checked). At the bottom, there are 'Update' and 'Reset' buttons.



**NOTE:** In case of Multi Label, the codes will be distinguished EITHER by their symbology, OR by their contents. If two (or more) codes share the same symbology and content, the scanner will perceive them as a unique code.

1. Enter the appropriate information in the form as described below:

Field Name	Action/Definition
<b>Code Combination</b>	Standard Multi Label has been selected.
<b>No Read Message</b>	Select <b>Disable No Read Message</b> , <b>Global No Read Message</b> , or <b>Local No Read(s) Message</b> from the drop-down list. The No Read condition occurs whenever a code cannot be read or decoded. <ul style="list-style-type: none"> <li>• <b>Disable No Read Message:</b> The No Read Message is not transmitted.</li> <li>• <b>Global No Read Message:</b> The No Read String will be sent if the scanner is unable to decode one or more barcodes in the reading phase.</li> </ul>

- **Local No Read(s) Message:** This option is useful when one or more codes are not read in the reading phase or when more codes than the expected number set by the configuration parameters are read.

If working in **Standard Multi Label** mode, this option activates the **Code Label Local No Read String** and the **Code Label Local Multiple Read String** parameters which allow setting a **Local No Read String** and a Local Multiple string for each defined code symbology.

---

**No Read String (max. 128 chars)**

Click  to activate the **Text Entry Tool** and create a string to be displayed when **Global No Read Message** is selected from the **No Read Message** drop-down list. Click **Submit** to save your text to the origin window text field, or click **Cancel** to return to origin window without transferring text.

---

**Multiple Read Message**

Select **Disable** or **Enable** from the drop-down list. This string will be sent if, during the reading phase, the scanner reads more than the number of the expected barcodes set by the configuration parameters.

---

**Multiple Read String (max. 128 chars)**

Click  to activate the **Text Entry Tool** and create a string to be displayed in case of **Multiple Read Message**. Click **Submit** to save your text to the origin window text field, or click **Cancel** to return to origin window without transferring text.

This parameter is only available when **Multiple Read Message** is enabled and the **No Read Message** selection is different from Local No Read(s) String. It is possible to select either the ASCII or HEX value. If disabled, the scanner transmits the first code read.

---

**Send All Multiple Read Labels**

For Advanced Data Format only, by enabling this parameter all multiple read labels will be included in the output message. They can be separated by the **Multiple Read Separator**.

**Multiple Read Label Separator String (max. 128 chars):**

The Multiple Read Label Separators (up to 128 bytes) are used to separate multiple read barcodes in the reading phase.

This is meaningful when the Code Combination parameter is set to Multi Label or Logical Combination and the Send All Multiple Read Labels parameter has been enabled.

If selected, they occur within the Code Field and are transmitted after each decoded multiple read barcode.

---

**Multi Filters**

Select the check box to display the **Multi-Filter Settings** options.

---

### Multi-Filter Settings

#### Contained Filter

Select the check box to reveal the **Max Number of Different Characters** field.

When checked, this filter attempts to eliminate false multiple reads by determining if a short code read is "contained in" (is a sub-string of), another longer code read. This condition implicates that the short code is probably a misread of the same longer code and therefore should be ignored, (should not be considered as a multiple read of a different code).

This filter is based upon the following rules:

- a multiple read condition occurs
- all decoded codes of the same type are compared with each other

**Rule 1:** the shorter code is considered contained in the longer code if the character string is found in the same order; the longer code may have a single block of characters in any position (before, after or in between the compared strings)

**Example:** The code **123456** is considered contained in the following codes: **00123456**, **12345600**, **12378456**.

The code **123456** is not considered contained in the following codes: **12346507** (string out of order), **12345700** (string not complete), **120378456** or **0012345600** (multiple blocks in the string).

**Rule 2:** the shorter code is not filtered by rule 1. In the longer code, all possible sub-strings of the same length as the shorter code string are compared with the shorter code string. The shorter code is considered contained in the longer code if the number of different characters between the compared codes is less than or equal to the Max Number of Different Characters. The shorter code will be filtered by rule 2.

**Example:**

If Max Number of Different Characters = 1:

The code **123456** is considered contained in the following codes: **12305600**, **00123056**, **8812305688** because there is only one different character in the compared string.

The code **123456** is not considered contained in **123066789** because there are two different characters in the compared string.



**CAUTION:** If the Contained Filter parameter is used when **Message Tx Selection** (see section 3.5.7) is set to **On Decoding**, the filter conditions may be satisfied before the reading phase ends resulting in possible successive multiple read errors.

**Max Number of Different Characters**

Enter a value from 0 to 5 in the field provided to define the maximum number of different characters allowed to still consider a code as being included in another one and therefore to be filtered.

If the number of different characters between the compared codes exceeds the value of this parameter, the codes are considered as different and will not be filtered (a multiple read of a different code occurs).

If the number of different characters between the compared codes is less than or equal to the value of this parameter, the short code is considered as a sub-string of the longer code and will be filtered (no multiple read occurs).

**Examples:**

If **Max Number of Different Characters** = 2:

The code **123456** read once, is considered the same as the following codes read multiple times: **133056**, **123546**, **123457** because there are two or less different characters by position in the compared codes.

The code **123456** read once, is not considered the same as the following codes read multiple times: **153246**, **103057**, **654321** because there are at least three different characters by position in the compared codes.

**Voting Filter**

Select the check box to reveal the **Max Number of Different Characters** field.

When selected, this filter attempts to eliminate false multiple reads by comparing the number of different characters by position between two codes of the same type and length. This condition implicates that reading a code of the same type and length having very few different characters is probably a misread of the code itself and therefore the code read the least number of times should be ignored, (should not be considered as a multiple read of a different code).

This filter is based upon the following rules:

- a multiple read condition occurs;
- the two codes are of the same type;
- the two codes have the same length;
- the number of different characters by position is equal to or less than the number defined by the **Max Number of Different Characters** parameter;
- **Message Tx Selection** (see section 3.5.7) must be set to **After Reading Phase Off**.

**Filter Out Low Height Codes** Select the check box to reveal the **Minimum Readings Difference Between Scanners** field.



**Background:** This option was developed for the airports systems where there are often tall bar height codes and low bar height codes with the same content attached to baggage. Travelers will often remove the large, tall bar height code, while leaving the smaller, low bar height codes attached to the bag. The next time they travel they may have multiple low bar height codes on their baggage plus the new tall bar height and low bar height codes for the new trip.

This option instructs the system to ignore low bar height codes, which are likely read only once or twice, in favor of tall bar height codes, which will likely be read multiple times.

This is used in tunnel applications where multiple barcodes are read and there is a need to filter out one of the barcodes. If less than  $x$  number of scanners read the barcode, then it will be considered a NOREAD for that code.

<b>Minimum Readings Difference Between Scanners</b>	Enter the minimum number of scanners that must read a barcode for it to be considered a valid read.
<b>Filter Out Single Readings</b>	With the check box selected, if only 1 scanner reads a code it will be considered a NOREAD.
<b>Strip Filter</b>	Select the check box to display the <b>Strip Filter Settings</b> options. This is a second level filter that when enabled allows eliminating characters not managed by the host.

#### Strip Filter Settings

<b>Strip All Non Printable Chars</b>	Select the check box to remove all non- printable ASCII characters from the code (000-020 and 127).
<b>Char(s) to be Stripped</b>	Click  to activate the Text Entry Tool and enter specific characters to be stripped from the code. Click <b>Submit</b> to save your text to the origin window text field, or click <b>Cancel</b> to return to origin window without transferring text.
<b>Strip Filter Collapse</b>	Select the check box to remove the stripped characters from the code and, therefore, reduce the code length (collapsed). It can even be null.
<b>Replacement Char</b>	Click  to activate the Text Entry Tool and enter the substitution character to replace all the stripped ones. Click <b>Submit</b> to save your text to the origin window text field, or click <b>Cancel</b> to return to origin window without transferring text.

- When you have finished making changes, click **Update** to save or click **Reset** to revert to the previously saved values.

## Barcode Configuration > Logical Combination

When **Logical Combination** has been selected from the **Code Combination** drop-down list, the Barcode Configuration window reveals related input fields.

The screenshot displays the 'Barcode Configuration' window with the following settings:

- Code Combination:** Logical Combination (dropdown)
- Logical Combination Rule:** 1^2&2^3 (text input)
- No Read Message:** Global No Read Mess: (dropdown)
- No Read String (max. 128 chars):** NOREAD (text input)
- Multiple Read Message:** Enable (dropdown)
- Multiple Read String (max. 128 chars):** ? (text input)
- Web Sentinel - Partial Read Is Treated As:** Partial Read (dropdown)
- Multi Filters:**
- Multi-Filter Settings:**
  - Contained Filter:
  - Max Number of Different Characters: 0 (text input)
  - Voting Filter:
  - Max Number of Different Characters: 2 (text input)
  - Filter Out Low Height Codes:
  - Minimum Readings Difference Between Scanners: 2 (text input)
  - Filter Out Single Readings:
  - Strip Filter:
  - Strip Filter Settings:**
    - Strip All Non Printable Chars:
    - Char(s) to be Stripped: (text input)
    - Strip Filter Collapse:

Buttons: Update, Reset

1. Enter the appropriate information in the form as described below:

Field Name	Action/Definition
Code Combination	Standard Multi Label has been selected.

**Logical Combination Rule** Click  to activate the code group selection dialog box.

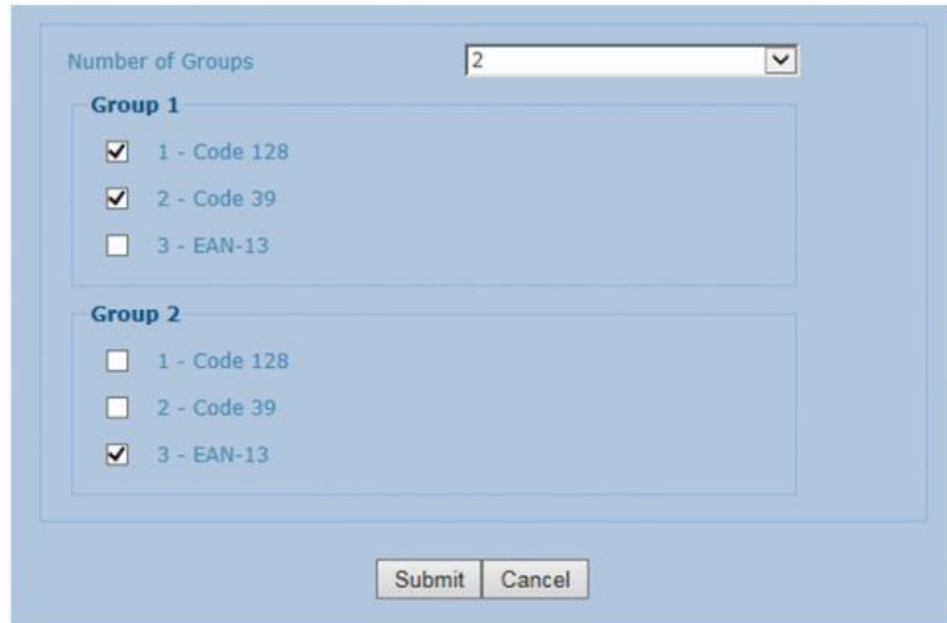

Select the number of groups you wish to use from the Number of Groups drop-down list. Then select the check box next to the Group/Code you wish to define. Click **Submit** to save your text to the origin window text field, or click **Cancel** to return to origin window without transferring text.

Groups and their order define the output message format, while each group identifies an expected code.

When editing the logical combination rule, proceed as follows:

1. Define the Barcode Settings indicating the type of expected code labels. It is possible to define up to 10 different code types;
2. Define how many code types (groups) are expected by editing the combination rule through the following logical operators. Each group may include one or more selected code types.

& = AND operator which separates a group from the previous/following one;

^ = XOR operator to be used to combine different code labels within the same group. It allows reading one of the defined code labels.

The maximum number of groups to be defined for each rule string is 15.

If Local No Read Message is selected from the No Read Message drop-down list, the Group No Read Messages parameter group is displayed requiring the definition of a Local No Read String for each group.

**Examples: Logical Combination Rule**

For all the following examples the **No Read Message** parameter is set to **Global No Read Message**.

**Example 1**

Code label setting#1 = Code 128  
 Logical Combination Rule = 1&1  
 Defines 2 groups, each of them expecting a Code 128 label.

Decoded Code Symbology		Output Message
First Label #1	Second Label #1	
---	---	<Header><Global No Read Message><Terminator>
X	---	<Header><Global No Read Message><Terminator>
---	X	<Header><Global No Read Message><Terminator>
X	X	<Header><Code 128 data><Data Packet Separator><Code 128 data><Terminator>



**NOTE:** If **Multiple Read Message** is enabled and a third label belonging to the Code 128 symbology is decoded, the **Multiple Read** string is transmitted instead. If the **Multiple Read Message** is disabled, the third code label is ignored and only the first two codes are transmitted.

For advanced formatting, if the **Send All Multiple Read Labels** parameter is enabled, then all three labels are sent in the output message; the multiple read label is separated by its own **Multiple Read Label Separator String** which should be different from the **Data Packet Separator (DPS)**.

**Example 2**

Code label setting#1 = Code 39  
 Code label setting#2 = Code 128  
 Logical Combination Rule = 1^2  
 Defines a single group expecting a Code 128 label OR a Code 39 label.

Decoded Code Symbology		Output Message
Label #1	Label #2	
---	---	<Header><Global No Read Message><Terminator>
X	---	<Header><Code 39 data><Terminator>
---	X	<Header><Code 128 data><Terminator>
X	X	<Header><First decoded code/Multiple Read Message string ><Terminator>



**Example 3**

Code label setting#1 = EAN 8

Code label setting#2 = UPC-A

Logical Combination Rule = 1&1&1^2

Defines three different groups. The first two groups expect an EAN 8 label while the third one expects an EAN 8 label OR an UPC-A label.

Decoded Code Symbology				Output Message
First Label #1	Second Label #1	Third Label #1	Label #2	
---	---	---	---	<Header><Global No Read Message><Terminator>
X	---	---	---	<Header><Global No Read Message><Terminator>
---	X	---	---	<Header><Global No Read Message><Terminator>
---	---	X	---	<Header><Global No Read Message><Terminator>
---	---	---	X	<Header><Global No Read Message><Terminator>
X	X	X	---	<Header><EAN 8 data><DPS><EAN 8 data><DPS><EAN 8 data><Terminator>
X	X	---	X	<Header><EAN 8 data><DPS><EAN 8 data><DPS><UPC-A data><Terminator>
X	X	X	X	<Header><EAN 8 data><DPS><EAN 8 data><DPS><First decoded code/Multiple Read Message string><Terminator>

**Example 4**

Code label setting#1 = Code 93  
 Code label setting#2 = Interleaved 2/5  
 Code label setting#3= EAN-8  
 Code label setting#4= UPC-A

Logical Combination Rule = 1^2&3^4

Defines 2 groups, each of them expecting one of the defined code types. The first group may expect a Code 93 label or an Interleaved 2/5 label. The second group may expect an EAN-8 label or an UPC-A label.

Decoded Code Symbology				Output Message
Label #1	Label #2	Label #3	Label #4	
---	---	---	---	<Header><Global No Read Message><Terminator>
X	---	---	---	<Header><Global No Read Message><Terminator>
---	X	---	---	<Header><Global No Read Message><Terminator>
---	---	X	---	<Header><Global No Read Message><Terminator>
---	---	---	X	<Header><Global No Read Message><Terminator>
X	X	---	---	<Header><Global No Read Message><Terminator>
X	---	X	X	<Header><Code93><DPS>< First decoded code/Multiple Read Message string><Terminator>
X	X	X	---	<Header><First decoded code/Multiple Read Message string><DPS><EAN 8 data><Terminator>
---	X	X	X	<Header>< Interleaved 2/5 data><DPS>< First decoded code/Multiple Read Message string ><Terminator>
X	---	X	---	<Header><Code 93 data><DPS><EAN 8 data><Terminator>
X	---	---	X	<Header><Code 93 data><DPS><UPC-A data><Terminator>
---	X	X	---	<Header><Interleaved 2/5 data><DPS><EAN 8 data><Terminator>
---	X	---	X	<Header><Interleaved 2/5 data><DPS><UPC-A data><Terminator>
X	X	X	X	<Header><First decoded code/Multiple Read Message string><DPS>< First decoded code/Multiple Read Message string ><Terminator>

**No Read Message** Select **Disable No Read Message**, **Global No Read Message**, or **Local No Read(s) Message** from the drop-down list. The **No Read** condition occurs whenever a code cannot be read or decoded.

- **Disable No Read Message:** The No Read Message is not transmitted.
- **Global No Read Message:** The No Read String will be sent if the scanner is unable to decode one or more barcodes in the reading phase.
- **Local No Read(s) Message:** This option is useful when one or more codes are not read in the reading phase or when more codes than the expected number set by the configuration parameters are read.

If working in Standard Multi Label mode, this option activates the Code Label Local No Read String and the Code Label Local Multiple Read String parameters which allow setting a Local No Read String and a Local Multiple string for each defined code symbology.

---

**No Read String (max. 128 chars)** Click  to activate the Text Entry Tool and create a string to be displayed when **Global No Read Message** is selected from the **No Read Message** drop-down list. Click **Submit** to save your text to the origin window text field, or click **Cancel** to return to origin window without transferring text.

---

**Multiple Read Message** Select **Disable** or **Enable** from the drop-down list. This string will be sent if, during the reading phase, the scanner reads more than the number of the expected barcodes set by the configuration parameters.

---

**Multiple Read String (max. 128 chars)** Click  to activate the Text Entry Tool and create a string to be displayed in case of Multiple Read Message. Click **Submit** to save your text to the origin window text field, or click **Cancel** to return to origin window without transferring text.

This parameter is only available when **Multiple Read Message** is enabled and the **No Read Message** selection is different from Local No Read(s) String. It is possible to select either the ASCII or HEX value. If **disabled**, the scanner transmits the first code read.

---

**Send All Multiple Read Labels** For **Advanced Data Format** only, by enabling this parameter all multiple read labels will be included in the output message. They can be separated by the **Multiple Read Separator**.

**Multiple Read Label Separator String (max. 128 chars):**

The Multiple Read Label Separators (up to 128 bytes) are used to separate multiple read barcodes in the reading phase.

This is meaningful when the Code Combination parameter is set to Multi Label or Logical Combination and the Send All Multiple Read Labels parameter has been enabled.

If selected, they occur within the Code Field and are transmitted after each decoded multiple read barcode.

---

**WebSentinel – Partial Read Is Treated As** Select **No Read**, **Good Read**, or **Partial Read** from the drop-down list. This determines how WebSentinel will treat the partial read.

---

**Multi Filters** Select the check box to display the **Multi-Filter Settings** options.

### Multi-Filter Settings

**Contained Filter** Select the check box to reveal the **Max Number of Different Characters** field.

When checked, this filter attempts to eliminate false multiple reads by determining if a short code read is "contained in" (is a sub-string of), another longer code read. This condition implicates that the short code is probably a misread of the same longer code and therefore should be ignored, (should not be considered as a multiple read of a different code).

This filter is based upon the following rules:

- a multiple read condition occurs
- all decoded codes of the same type are compared with each other

**Rule 1:** the shorter code is considered contained in the longer code if the character string is found in the same order; the longer code may have a single block of characters in any position (before, after or in between the compared strings)

**Example:** The code **123456** is considered contained in the following codes: **00123456**, **12345600**, **12378456**.

The code **123456** is not considered contained in the following codes: **12346507** (string out of order), **12345700** (string not complete), **120378456** or **0012345600** (multiple blocks in the string).

**Rule 2:** the shorter code is not filtered by rule 1. In the longer code, all possible sub-strings of the same length as the shorter code string are compared with the shorter code string. The shorter code is considered contained in the longer code if the number of different characters between the compared codes is less than or equal to the **Max Number of Different Characters**. The shorter code will be filtered by rule 2.

If Max Number of Different Characters = 1:

The code **123456** is considered contained in the following codes: **12305600**, **00123056**, **8812305688** because there is only one different character in the compared string.

The code **123456** is not considered contained in **123066789** because there are two different characters in the compared string.



**CAUTION:** If the Contained Filter parameter is used when **Message Tx Selection** (see section 3.5.7) is set to **On Decoding**, the filter conditions may be satisfied before the reading phase ends resulting in possible successive multiple read errors.

**Max Number of Different Characters** Enter a value from 0 to 5 in the field provided to define the maximum number of different characters allowed to still consider a code as being included in another one and therefore to be filtered.

If the number of different characters between the compared codes exceeds the value of this parameter, the codes are considered as different and will not be filtered (a multiple read of a different code occurs).

If the number of different characters between the compared codes is less than or equal to the value of this parameter, the short code is considered as a substring of the longer code and will be filtered (no multiple read occurs).

**Examples:**

If Max Number of Different Characters = 2:

The code **123456** read once, is considered the same as the following codes read multiple times: **133056**, **123546**, **123457** because there are two or less different characters by position in the compared codes.

The code **123456** read once, is not considered the same as the following codes read multiple times: **153246**, **103057**, **654321** because there are at least three different characters by position in the compared codes.

---

**Voting Filter**

Select the check box to reveal the **Max Number of Different Characters** field.

When checked, this filter attempts to eliminate false multiple reads by comparing the number of different characters by position between two codes of the same type and length. This condition implicates that reading a code of the same type and length having very few different characters is probably a misread of the code itself and therefore the code read the least number of times should be ignored, (should not be considered as a multiple read of a different code).

This filter is based upon the following rules:

- a multiple read condition occurs;
- the two codes are of the same type;
- the two codes have the same length;
- the number of different characters by position is equal to or less than the number defined by the **Max Number of Different Characters** parameter;
- **Message Tx Selection** (see section 3.5.7) must be set to **After Reading Phase Off**.

---

**Filter Out Low Height Codes**

Select the check box to reveal the **Minimum Readings Difference Between Scanners** field.

**Background:** This option was developed for the airports systems where there are often tall bar height codes and low bar height codes with the same content attached to baggage. Travelers will often remove the large, tall bar height code, while leaving the smaller, low bar height codes attached to the bag. The next time they travel they may have multiple low bar height codes on their baggage plus the new tall bar height and low bar height codes for the new trip.

This option instructs the system to ignore low bar height codes, which are likely read only once or twice, in favor of tall bar height codes, which will likely be read multiple times.

This is used in tunnel applications where multiple barcodes are read and there is a need to filter out one of the barcodes. If less than  $x$  number of scanners read the barcode, then it will be considered a NOREAD for that code.

---

**Minimum Readings Difference Between Scanners**

Enter the minimum number of scanners that must read a barcode for it to be considered a valid read.

---

**Filter Out Single Readings** With the check box selected, if only 1 scanner reads a code it will be considered a NOREAD.

**Strip Filter** Select the check box to display the **Strip Filter Settings** options. This is a second level filter that when enabled allows eliminating characters not managed by the host.

#### Strip Filter Settings

**Strip All Non Printable Chars** Select the check box to remove all non- printable ASCII characters from the code (000-020 and 127).

**Char(s) to be Stripped** Click  to activate the **Text Entry Tool** and enter specific characters to be stripped from the code. Click **Submit** to save your text to the origin window text field, or click **Cancel** to return to origin window without transferring text.

**Strip Filter Collapse** Select the check box to remove the stripped characters from the code and, therefore, reduce the code length (collapsed). It can even be null.

**Replacement Char** Click  to activate the **Text Entry Tool** and enter the substitution character to replace all the stripped ones. Click **Submit** to save your text to the origin window text field, or click **Cancel** to return to origin window without transferring text.

- When you have finished making changes, click **Update** to save or click **Reset** to revert to the previously saved values.

## Barcode Configuration > Code Collection

When **Code Collection** has been selected from the **Code Combination** drop-down list, the Barcode Configuration window reveals related input fields.

The screenshot shows the Barcode Configuration window with the following settings:

- Code Combination:** Code Collection (selected)
- No Read Message:** Global No Read Mess: (dropdown)
- No Read String (max. 128 chars):** NOREAD
- Code Collection Settings:**
  - Associate Same Codes When Read By Different Scanners:
  - Code Different When Scan Gap Is Greater Than: 0
  - Code Different When Code Position Gap Is Greater Than: 0
- Multi Filters:**
- Multi-Filter Settings:**
  - Contained Filter:
  - Max Number of Different Characters: 0
  - Voting Filter:
  - Max Number of Different Characters: 2
  - Filter Out Low Height Codes:
  - Minimum Readings Difference Between Scanners: 2
  - Filter Out Single Readings:
  - Strip Filter:
  - Strip Filter Settings:**
    - Strip All Non Printable Chars:
    - Char(s) to be Stripped: (empty text box)
    - Strip Filter Collapse:

Buttons: Update, Reset

1. Enter the appropriate information in the form as described below:

Field Name	Action/Definition
<b>Code Combination</b>	<b>Code Collection</b> has been selected.

<b>No Read Message</b>	Select <b>Disable No Read Message</b> , <b>Global No Read Message</b> , or <b>Local No Read(s) Message</b> from the drop-down list. The No Read condition occurs whenever a code cannot be read or decoded.
------------------------	---

- **Disable No Read Message:** The No Read Message is not transmitted.
- **Global No Read Message:** The No Read String will be sent if the scanner is unable to decode one or more barcodes in the reading phase.
- **Local No Read(s) Message:** This option is useful when one or more codes are not read in the reading phase or when more codes than the expected number set by the configuration parameters are read.

If working in Standard Multi Label mode, this option activates the Code Label Local No Read String and the Code Label Local Multiple Read String parameters which allow setting a Local No Read String and a Local Multiple string for each defined code symbology.

**No Read String  
(max. 128 chars)**

Click  to activate the **Text Entry Tool** and create a string to be displayed when **Global No Read Message** is selected from the **No Read Message** drop-down list. Click **Submit** to save your text to the origin window text field, or click **Cancel** to return to origin window without transferring text.

**Multi Filters**

Select the check box to display the **Multi-Filter Settings** options.

**Code Collection Settings**

**Associate Same Codes When Read By Different Scanners**

Select the check box to enable this function.

This parameter is available only when the **Code Combination** parameter is set to **Code Collection** and the scanner role is **Master**. If enabled, it allows transmitting all codes belonging to the same programmed Slot (same symbology and content) but read by different scanners (including the Master) in a single instance.

**Scanner Role:**

- **Master SYNCHRONIZED:** The scanner is connected as a Master in a master/slave synchronized configuration.
- **Slave SYNCHRONIZED:** The scanner is connected as a Slave in a master/slave synchronized configuration. (See note below.)
- **Other:** This selection is for a stand-alone scanner.

**Code Different When Scan Gap Is Greater Than**

This parameter is available only when the **Code Combination** parameter is set to **Code Collection**. If the number of scans performed between two consecutive codes read (by the Master or Stand Alone scanner) is greater than the defined number, the codes will be considered as different.

The parameter set to 0 means the filter is disabled: when there is no scan gap all the consecutive codes read will be considered as only one code.

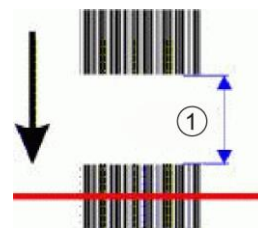

① Scan Gap

**Code Different When Code Position Gap Is Greater Than**

This parameter is available only when the **Code Combination** parameter is set to **Code Collection**. If the position gap between two consecutive codes read (by the Master or Stand Alone scanner) on the same scan line is greater than the defined gap number, the codes will be considered as different.

The parameter set to 0 means the filter is disabled: when there is no code position gap all the consecutive codes read will be considered as only one code.

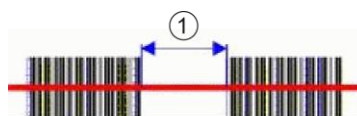

① Code Position Gap



### Multi-Filter Settings

**Contained Filter** Select the check box to reveal the **Max Number of Different Characters** field.

When checked, this filter attempts to eliminate false multiple reads by determining if a short code read is "contained in" (is a sub-string of), another longer code read. This condition implicates that the short code is probably a misread of the same longer code and therefore should be ignored, (should not be considered as a multiple read of a different code).

This filter is based upon the following rules:

- a multiple read condition occurs
- all decoded codes of the same type are compared with each other

**Rule 1:** the shorter code is considered contained in the longer code if the character string is found in the same order; the longer code may have a single block of characters in any position (before, after or in between the compared strings)

**Example:** The code **123456** is considered contained in the following codes: 00**123456**, **123456**00, **12378456**.

The code **123456** is not considered contained in the following codes: 1234**65**07 (string out of order), 12345**700** (string not complete), 120**378**456 or **00**123456**00** (multiple blocks in the string).

**Rule 2:** the shorter code is not filtered by rule 1. In the longer code, all possible sub-strings of the same length as the shorter code string are compared with the shorter code string. The shorter code is considered contained in the longer code if the number of different characters between the compared codes is less than or equal to the **Max Number of Different Characters**. The shorter code will be filtered by rule 2.

**Example:**

If Max Number of Different Characters = 1:

The code **123456** is considered contained in the following codes: **123056**00, 00**123056**, 88**123056**88 because there is only one different character in the compared string.

The code **123456** is not considered contained in **123066**789 because there are two different characters in the compared string.



**CAUTION:** If the **Contained Filter** parameter is used when **Message Tx Selection** (see section 3.5.7) is set to **On Decoding**, the filter conditions may be satisfied before the reading phase ends resulting in possible successive multiple read errors.

**Max Number of Different Characters** Enter a value from 0 to 5 in the field provided to define the maximum number of different characters allowed to still consider a code as being included in another one and therefore to be filtered.

If the number of different characters between the compared codes exceeds the value of this parameter, the codes are considered as different and will not be filtered (a multiple read of a different code occurs).

If the number of different characters between the compared codes is less than

or equal to the value of this parameter, the short code is considered as a substring of the longer code and will be filtered (no multiple read occurs).

**Examples:**

If Max Number of Different Characters = 2:

The code **123456** read once, is considered the same as the following codes read multiple times: **133056**, **123546**, **123457** because there are two or less different characters by position in the compared codes.

The code **123456** read once, is not considered the same as the following codes read multiple times: **153246**, **103057**, **654321** because there are at least three different characters by position in the compared codes.

<p><b>Voting Filter</b></p>	<p>Select the check box to reveal the Max Number of Different Characters field. When checked, this filter attempts to eliminate false multiple reads by comparing the number of different characters by position between two codes of the same type and length. This condition implicates that reading a code of the same type and length having very few different characters is probably a misread of the code itself and therefore the code read the least number of times should be ignored, (should not be considered as a multiple read of a different code).</p> <p>This filter is based upon the following rules:</p> <ul style="list-style-type: none"> <li>• a multiple read condition occurs;</li> <li>• the two codes are of the same type;</li> <li>• the two codes have the same length;</li> <li>• the number of different characters by position is equal to or less than the number defined by the <b>Max Number of Different Characters</b> parameter;</li> <li>• <b>Message Tx Selection</b> (see section 3.5.7) must be set to <b>After Reading Phase Off</b>.</li> </ul>
<p><b>Filter Out Low Height Codes</b></p>	<p>Select the check box to reveal the <b>Minimum Readings Difference Between Scanners</b> field.</p> <p><b>Background:</b> This option was developed for the airports systems where there are often tall bar height codes and low bar height codes with the same content attached to baggage. Travelers will often remove the large, tall bar height code, while leaving the smaller, low bar height codes attached to the bag. The next time they travel they may have multiple low bar height codes on their baggage plus the new tall bar height and low bar height codes for the new trip.</p> <p>This option instructs the system to ignore low bar height codes, which are likely read only once or twice, in favor of tall bar height codes, which will likely be read multiple times.</p> <p>This is used in tunnel applications where multiple barcodes are read and there is a need to filter out one of the barcodes. If less than <i>x</i> number of scanners read the barcode, then it will be considered a NOREAD for that code.</p>
<p><b>Minimum Readings Difference Between Scanners</b></p>	<p>Enter the minimum number of scanners that must read a barcode for it to be considered a valid read.</p>

**Filter Out Single Readings** With the check box selected, if only 1 scanner reads a code it will be considered a NOREAD.

**Strip Filter** Select the check box to display the **Strip Filter Settings** options. This is a second level filter that when enabled allows eliminating characters not managed by the host.

#### Strip Filter Settings

**Strip All Non Printable Chars** Select the check box to remove all non- printable ASCII characters from the code (000-020 and 127).

**Char(s) to be Stripped** Click  to activate the **Text Entry Tool** and enter specific characters to be stripped from the code. Click **Submit** to save your text to the origin window text field, or click **Cancel** to return to origin window without transferring text.

**Strip Filter Collapse** Select the check box to remove the stripped characters from the code and, therefore, reduce the code length (collapsed). It can even be null.

**Replacement Char** Click  to activate the **Text Entry Tool** and enter the substitution character to replace all the stripped ones. Click **Submit** to save your text to the origin window text field, or click **Cancel** to return to origin window without transferring text.

- When you have finished making changes, click **Update** to save or click **Reset** to revert to the previously saved values.

### 3.5.4 Modify Settings | Global Settings | Serial Ports

Use the Serial Ports menu tree selections during initial setup to configure any serial ports used by your barcode scanning system. If necessary, you can later make modifications to the global system settings using the same menu selections, including:



#### Modify Settings | Global Settings | Serial Ports | Main Port

Use **Main Port** window to configure communication between the scanner and the Host, or in a multi-sided layout, between the Master (scanner/controller) and a Host.

To edit the **Main Port** settings:

1. In the tree menu under **Modify Settings**, navigate to **Global Settings | Serial Ports | Main Port**. The Main Port window opens.



The screenshot shows the 'Main Serial Port' configuration window. At the top, there is a 'Data Tx' checkbox which is checked. Below it is a 'Heartbeat' dropdown menu set to 'Enable Unconditioned'. The 'Heartbeat Settings' section contains three fields: 'Heartbeat Timeout' (60 sec), 'Heartbeat Message (max. 32 chars)' (containing '<STX>'), and 'Heartbeat Terminator (max. 32 chars)' (containing '<ETX>'). There is also a 'Send Diagnostic Info' checkbox. The 'Line Settings' section contains several dropdown menus: 'Main Port Electrical Interface' (RS232), 'Handshake' (None), 'Baud Rate' (115200), 'Parity' (None), 'Data Bits' (8), and 'Stop Bits' (1). At the bottom of the window are 'Update' and 'Reset' buttons.

2. Enter the appropriate information in the form as described below:

Field Name	Action/Definition
Data Tx	Select the check box to enabled <b>Data Tx</b> . If selected, the <b>Main Serial Port</b> channel is used by the scanner to transmit data and/or messages.

<b>Heartbeat</b>	<p>Select <b>Disable</b>, <b>Enable Unconditioned</b>, or <b>Enable Conditioned</b> from the drop-down list. This parameter is available when the <b>Data TX</b> parameter is checked. It enables/disables the transmission of the Heartbeat message signaling that the device is still active.</p> <ul style="list-style-type: none"> <li>• <b>Disable:</b> The Heartbeat message is not transmitted</li> <li>• <b>Enable Unconditioned:</b> The Heartbeat message is always transmitted, even if communication is still active</li> <li>• <b>Enable Conditioned:</b> The Heartbeat message is transmitted only when there is no communication</li> </ul>
------------------	--

### Heartbeat Settings

<b>Heartbeat Timeout</b>	Enter a time value in seconds to define the amount of time between two message transmissions. If the input timeout expires and no transmission has occurred, the Heartbeat message will be transmitted.
<b>Heartbeat Message (max. 32 chars)</b>	<p>Click  to activate the Text Entry Tool and create heartbeat header text to signal the beginning of the heartbeat message. Characters from NUL (00H) to ~ (7EH) can be used. Click <b>Submit</b> to save your text to the origin window text field, or click <b>Cancel</b> to return to origin window without transferring text.</p> <p>The <b>Heartbeat Message</b> (header) string must be different from the <b>Heartbeat Terminator</b> string.</p>
<b>Heartbeat Terminator (max. 32 chars)</b>	<p>Click  to activate the Text Entry Tool and create <b>Heartbeat Terminator</b> text to signal the end of the heartbeat message. Characters from NUL (00H) to ~ (7EH) can be used. Click <b>Submit</b> to save your text to the origin window text field, or click <b>Cancel</b> to return to origin window without transferring text.</p> <p>The <b>Heartbeat Terminator</b> string must be different from the <b>Heartbeat Message</b> (header) string.</p>

### Line Settings

<b>Main Port Electrical Interface</b>	Select <b>RS232</b> or <b>RS422 full duplex</b> from the drop-down list. The Main serial interface is compatible with these available electrical standards.
<b>Handshake</b>	Select <b>None</b> , <b>Hardware (RTS/CTS)</b> , or <b>Software (Xon/Xoff)</b> from the drop-down list. Handshake is a communication control used to protect against data loss, it can be achieved via hardware (RTS\CTS protocol) or software (Xon\Xoff protocol).
<b>Baud Rate</b>	Select a value from <b>1200</b> to <b>115200</b> from the drop-down list. <b>Baud Rate</b> is the transmission speed in a communication line.
<b>Parity</b>	Select <b>None</b> , <b>Odd</b> , or <b>Even</b> from the drop-down list. <b>Parity</b> is a parameter indicating the presence of a control bit in the communication protocol frame.
<b>Data Bits</b>	Select <b>7</b> or <b>8</b> from the drop-down list. <b>Data Bits</b> is a parameter indicating the number of bits composing the data packet of the communication protocol frame.

**Stop Bits** Select **1** or **2** from the drop-down list. **Stop Bits** is a parameter indicating the number of stop bits in the data packet of the communication protocol frame.

- When you have finished making changes, click **Update** to save or click **Reset** to revert to the previously saved values.

## Modify Settings | Global Settings | Serial Ports | Aux Port

Use the **Aux Port** window to configure communication through the Auxiliary Serial Port. For this communication mode, RS232 interface is automatically selected.

### To edit the Aux Port settings:

- In the tree menu under **Modify Settings**, navigate to **Global Settings | Serial Ports | Aux Port**. The Aux Port window opens.

- Enter the appropriate information in the form as described below:

Field Name	Action/Definition
<b>Search for MA900 BM100 at Device Startup</b>	Select the check box to automatically search for a BM100 storage module when the scanner is powered on.
<b>Data Tx</b>	Select the check box to enabled <b>Data Tx</b> . If selected, the <b>Aux Serial Port</b> channel is used by the scanner to transmit data and/or messages.

**Heartbeat**

Select **Disable**, **Enable Unconditioned**, or **Enable Conditioned** from the drop-down list. This parameter is available when the **Data TX** parameter is checked. It enables/disables the transmission of the Heartbeat message signaling that the device is still active.

- **Disable:** The Heartbeat message is not transmitted
- **Enable Unconditioned:** The Heartbeat message is always transmitted, even if communication is still active
- **Enable Conditioned:** The Heartbeat message is transmitted only when there is no communication

---

### Heartbeat Settings

---

**Heartbeat Timeout**

Enter a time value in seconds to define the amount of time between two message transmissions. If the input timeout expires and no transmission has occurred, the Heartbeat message will be transmitted.

**Heartbeat Message (max. 32 chars)**

Click  to activate the **Text Entry Tool** and create heartbeat header text to signal the beginning of the heartbeat message. Characters from NUL (00H) to ~ (7EH) can be used. Click **Submit** to save your text to the origin window text field, or click **Cancel** to return to origin window without transferring text.

The Heartbeat Message (header) string must be different from the Heartbeat Terminator string.

**Heartbeat Terminator (max. 32 chars)**

Click  to activate the **Text Entry Tool** and create **Heartbeat Terminator** text to signal the end of the heartbeat message. Characters from NUL (00H) to ~ (7EH) can be used. Click **Submit** to save your text to the origin window text field, or click **Cancel** to return to origin window without transferring text.

The **Heartbeat Terminator** string must be different from the Heartbeat Message (header) string

---

### Line Settings

---

**Baud Rate**

Select a value from 1200 to 115200 from the drop-down list. **Baud Rate** is the transmission speed in a communication line.

**Parity**

Select **None**, **Odd**, or **Even** from the drop-down list. **Parity** is a parameter indicating the presence of a control bit in the communication protocol frame.

**Data Bits**

Select 7 or 8 from the drop-down list. **Data Bits** is a parameter indicating the number of bits composing the data packet of the communication protocol frame.

**Stop Bits**

Select 1 or 2 from the drop-down list. **Stop Bits** is a parameter indicating the number of stop bits in the data packet of the communication protocol frame.

---

3. When you have finished making changes, click **Update** to save or click **Reset** to revert to the previously saved values.

### 3.5.5 Modify Settings | Global Settings | Ethernet

Use the **Ethernet** menu tree selections during initial setup to configure the Ethernet settings for your barcode scanning system.

Ethernet is the most popular physical layer LAN technology in use today. It is the IEEE 802.3 series standard, based on the CSMA/CD access method that provides two or more stations to share a common cabling system. This access method, Carrier Sense Multiple Access with Collision Detection, is the basis for Ethernet systems providing a wide range of speed.

The design goals for Ethernet are to create a simply defined topology that makes efficient use of shared resources that are easy to reconfigure and maintain and provides compatibility across many manufacturer and systems.

Ethernet supports many different network protocols; Leuze electronic scanners support IP plus TCP or UDP over Ethernet and 802.3 frame format as Ethernet protocol low level.

If necessary, you can later make modifications to the global system settings using the same menu selections, including:

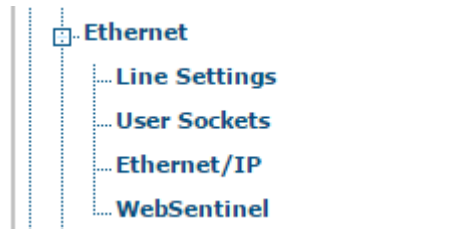



## Modify Settings | Global Settings | Ethernet | Line Settings

Use the **Line Settings** window to define and report the fundamental information about the system.

### To edit the Line Settings:

1. In the tree menu under Modify Settings, navigate to Global Settings | Ethernet | Line Settings. The Line Settings window opens.

The screenshot shows a web-based configuration interface for network settings. It is divided into two main sections: 'Host Network (ETH1)' and 'Setup Network (ETH2)'. The 'Host Network (ETH1)' section includes a checkbox for 'Enable DHCP' (which is checked), and five text input fields for 'IP Address' (10.27.152.192), 'IP Netmask' (255.255.248.0), 'IP Gateway' (10.27.152.21), 'IP DNS1' (0.0.0.0), and 'IP DNS2' (0.0.0.0). The 'Setup Network (ETH2)' section includes two text input fields for 'Setup IP Address' (192.168.3.101) and 'Setup Netmask' (255.255.255.0). At the bottom of the form are two buttons: 'Update' and 'Reset'.

2. Enter the appropriate information in the form as described below:

Field Name	Action/Definition
<b>Host Network (ETH1)</b>	
<b>Enable DHCP</b>	Select the check box to cause the IP address parameters to become inactive. They are then used to display the addresses assigned by a DHCP server when getting the scanner configuration.
<b>IP Address</b>	Enter the device Internet Protocol (IP) network address in the field provide. Consult your network administrator to obtain a new address.
<b>IP Netmask</b>	Enter the device subnet mask address in the field provided. Consult your network administrator to obtain a new address.
<b>IP Gateway</b>	Enter the device gateway address in the field provided. Consult your network administrator to obtain a new address.
<b>IP DNS1</b>	Enter the address of the Primary Domain Name System (DNS) in the field provided.
<b>IP DNS2</b>	Enter the address of the Secondary Domain Name System (DNS) in the field provided.

---

**Setup Network (ETH2)**

---

**Setup IP Address** Enter the Internet Protocol (IP) network address for ETH2 (Setup) in the field provided. Consult your network administrator to obtain a new address.

**Setup Netmask** Enter the subnet mask address for ETH2 (Setup) in the field provided. Consult your network administrator to obtain a new address.

---

3. When you have finished making changes, click **Update** to save or click **Reset** to revert to the previously saved values.

## Modify Settings | Global Settings | Ethernet | User Sockets

Use the **User Sockets** (User Socket Settings) window to setup, edit, and configure numbered user sockets for your barcode scanning system. User sockets are another interface available for the Ethernet communication.

**To edit the User Socket settings:**

1. In the tree menu under **Modify Settings**, navigate to **Global Settings | Ethernet | User Sockets**. The User Sockets window opens.

2. Enter the appropriate information in the form as described below:

Field Name	Action/Definition
------------	-------------------

<b>User Socket List</b>	Select an option button in the list at the top of this window to create a new user socket, or to edit an existing one.
-------------------------	--

User Socket <i>n</i>	
----------------------	--

<b>Enable User Socket</b>	Select the check box to enable <b>User Sockets</b> and reveal the related configuration options.
---------------------------	--

**Enable Data Transmission** Select the check box to enable **User Sockets** and reveal the related configuration options. When enabled, **Ethernet User Socket** is selected as the channel to be used by the scanner for transmitting data and/or messages.

**Heartbeat** Select **Disable**, **Enable Unconditioned**, or **Enable Conditioned** from the drop-down list. This parameter is available when the **Data TX** parameter is checked. It enables/disables the transmission of the Heartbeat message signaling that the device is still active.

- **Disable:** The Heartbeat message is not transmitted
- **Enable Unconditioned:** The Heartbeat message is always transmitted, even if communication is still active
- **Enable Conditioned:** The Heartbeat message is transmitted only when there is no communication

**Heartbeat Settings**

**Heartbeat Timeout** Enter a time value in seconds to define the amount of time between two message transmissions. If the input timeout expires and no transmission has occurred, the Heartbeat message will be transmitted.

**Heartbeat Message (max. 32 chars)** Click  to activate the **Text Entry Tool** and create heartbeat header text to signal the beginning of the heartbeat message. Characters from NUL (00H) to ~ (7EH) can be used. Click **Submit** to save your text to the origin window text field, or click **Cancel** to return to origin window without transferring text.

The **Heartbeat Message** (header) string must be different from the **Heartbeat Terminator** string.

**Heartbeat Terminator (max. 32 chars)** Click  to activate the **Text Entry Tool** and create **Heartbeat Terminator** text to signal the end of the heartbeat message. Characters from NUL (00H) to ~ (7EH) can be used. Click **Submit** to save your text to the origin window text field, or click **Cancel** to return to origin window without transferring text.

The **Heartbeat Terminator** string must be different from the **Heartbeat Message** (header) string

**Send Diagnostic Info** Select the check box to include diagnostic information in the heartbeat message.

**Socket Configuration**

**Type** Select **Server** or **Client** from the drop-down list to define the type of the socket:

- **Server:** The station waits for connections and can communicate with a maximum of 3 clients simultaneously
- **Client:** The station tries a connection towards the server

**Server Address** Enter the IP address of the server to which the client tries to connect. This parameter is available only when the socket is configured as a **Client**.

**Protocol** Select **TCP** (Transmission Control Protocol) or **UDP** (User Datagram Protocol) from the drop-down list to define the protocol to be used for the Ethernet communication.



**NOTE:** When using the UDP protocol:

- The User Socket Client Port is bound to the Server Port.
- The maximum size for maintaining a whole datagram is 1436 bytes, messages exceeding this value will be fragmented.

**Port** Enter the port number of the socket.

3. When you have finished making changes, click **Update** to save or click **Reset** to revert to the previously saved values.

## Modify Settings | Global Settings | Ethernet | Ethernet/IP

Use the **Ethernet I/P** window to set up digital inputs and outputs for the barcode scanner.

**To enable or disable Ethernet/IP:**

1. In the tree menu under **Modify Settings**, navigate to **Global Settings | Ethernet | Ethernet/IP**. The Ethernet/IP window opens.

2. Enter the appropriate information in the form as described below:

Field Name	Action/Definition
<b>Enable Ethernet/IP</b>	Select the check box to enable <b>Ethernet/IP</b> and reveal the related configuration options.

### Digital Input Lines

**Trigger (Input 1) Echo** Select **Disable** or **Enable** from the drop-down list.

Select **Enable** to echo the status of scanner **Input 1** to the Ethernet Client via bit 0 in Byte 0 (LSB) of the Input Area.

**Aux (Input 3) Echo** Select **Disable** or **Enable** from the drop-down list.

Select **Enable** to echo the status of scanner **Input 3** to the Ethernet Client via bit 1 in Byte 0 (LSB) of the Input Area.

**I/O 4 (Input 4) Echo** Select **Enable** or **Disable** from the drop-down list. If **Enable** is selected, the status of MSC 900 Input 4 is echoed to the Ethernet Client via bit 1 in Byte 0 (LSB) of the Input Area.

**Phase Echo** Select **Disable** or **Enable** from the drop-down list.

Select **Enable** to echo the scanner **Reading Phase** status to the Ethernet Client via bit 7 in Byte 0 (LSB) of the Input Area.

### Digital Output Lines

**Control Output 1** Select **Disable** or **Enable** from the drop-down list.

Select **Enable** to allow the Ethernet Client to drive the scanner **Output 1** via bit 0 in Byte 0 (LSB) of the Output Area.

**Control Output 2** Select **Disable** or **Enable** from the drop-down list.

Select **Enable** to allow the Ethernet Client to drive the scanner **Output 2** via bit 1 in Byte 0 (LSB) of the Output Area.

**Control Output 3** Select **Disable** or **Enable** from the drop-down list.

Select **Enable** to allow the Ethernet Client to drive the scanner **Output 3** via bit 0 in Byte 0 (LSB) of the Output Area.

**Control Output 4** Select **Disable** or **Enable** from the drop-down list.

Select **Enable** to allow the Ethernet Client to drive the scanner **Output 4** via bit 0 in Byte 0 (LSB) of the Output Area.

- When you have finished making changes, click **Update** to save or click **Reset** to revert to the previously saved values.

## Modify Settings | Global Settings | Ethernet | WebSentinel

Use the **WebSentinel™** window to enable and configure the barcode scanner for use with WebSentinel.

### To enable or disable WebSentinel:

1. In the tree menu under **Modify Settings**, navigate to **Global Settings | Ethernet | WebSentinel**. The WebSentinel window opens.

2. Enter the appropriate information in the form as described below:

Field Name	Action/Definition
<b>Enable</b>	Select the check box to enable <b>WebSentinel</b> and reveal the related configuration options.
<b>WebSentinel Socket</b>	Select a socket number for WebSentinel from those available in the drop-down list.
Monitor Settings	
<b>Conveyor Speed Check Type</b>	Select <b>Percentage</b> or <b>Absolute</b> from the drop-down list to determine how the conveyor speed is evaluated.
<b>Max Conveyor Speed Percent Error (%)</b>	In the text field provided, enter the percentage of discrepancy allowed in the conveyor speed before an error is sent. This option is available when <b>Percentage</b> is selected from the <b>Conveyor Speed Check Type drop-down list</b> .
<b>Input Timeout (secs)</b>	Enter a time interval in seconds, after which the input will be checked for errors. If an error is found, it will be sent to WebSentinel.
<b>Max Conveyor Speed Absolute Error (mm/s)</b>	In the text field provided, enter the milliseconds of discrepancy allowed in the conveyor speed before an error is sent. This option is available when <b>Absolute</b> is selected from the <b>Conveyor Speed Check Type drop-down list</b> .

3. When you have finished making changes, click **Update** to save or click **Reset** to revert to the previously saved values.

### 3.5.6 Fieldbus

Use the **Fieldbus** window to configure Fieldbus type communication between the scanner and Host, or, in a multi-sided layout, between several scanners and a Host.

**To edit the Fieldbus settings:**

1. In the tree menu under Modify Settings, navigate to **Global Settings | Fieldbus**. The Fieldbus window opens.

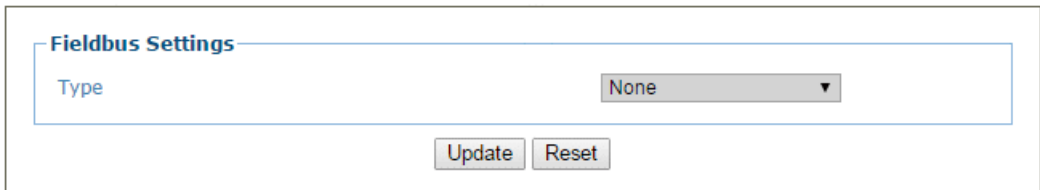

2. Enter the appropriate information in the form as described below:

Field Name	Action/Definition
Type	Select the Fieldbus type from those available in the drop-down list.
Data Tx	Select the check box to enabled <b>Data Tx</b> . If selected, the fieldbus port is used by the scanner to transmit data and/or messages.
Heartbeat	<p>Select Disable, Enable Unconditioned, or Enable Conditioned from the drop-down list.</p> <p>This parameter is available when the Data TX parameter is checked. It enables/disables the transmission of the Heartbeat message signalling that the device is still active.</p> <ul style="list-style-type: none"> <li>• <b>Disable:</b> The Heartbeat message is not transmitted</li> <li>• <b>Enable Unconditioned:</b> The Heartbeat message is always transmitted, even if communication is still active</li> <li>• <b>Enable Conditioned:</b> The Heartbeat message is transmitted only when there is no communication</li> </ul>
Heartbeat Settings	
Heartbeat Timeout	Enter a time value in seconds to define the amount of time between two message transmissions. If the input timeout expires and no transmission has occurred, the Heartbeat message will be transmitted.
Heartbeat Message (max. 32 chars)	<p>Click  to activate the Text Entry Tool and create heartbeat header text to signal the beginning of the heartbeat message. Characters from NUL (00H) to ~ (7EH) can be used.</p> <p>The Heartbeat Message (header) string must be different from the Heartbeat Terminator string.</p>



**Heartbeat Terminator  
(max. 32 chars)**

Click  to activate the Text Entry Tool and create Heartbeat Terminator text to signal the end of the heartbeat message. Characters from NUL (00H) to ~ (7EH) can be used.

The Heartbeat Terminator string must be different from the Heartbeat Message (header) string

---

**Flow Control Settings**

<b>Baud Rate</b>	Select a value from 1200 to 115200 from the drop-down list. Baud Rate is the transmission speed in a communication line.
<b>Data Flow Control</b>	Select <b>Disable</b> , <b>DAD Driver</b> , or <b>DPD Driver</b> from the drop-down list. This implements a reliable transmission protocol between Master (PLC) and Slave (DS6X00) allowing specific functions such as Synchronization, Fragmentation/Reassembling and Data Consistency.
<b>Consistency</b>	Select <b>Disable</b> or <b>Enable</b> from the drop-down list. This parameter is available only when the Data Flow Control parameter is set to DAD or DPD Driver. If enabled, it allows improving the overall communication robustness of the Profibus network.

**Profibus Settings**

<b>Node Address</b>	Enter a node value in the field provided, to define the value that distinguishes this node from all other nodes on the same link. Each node identifies a device within the network.
<b>Master Input Area Size</b>	This is a read-only parameter, which shows the dimension of the Master Input Area.
<b>Master Output Area Size</b>	This is a read-only parameter, which shows the dimension of the Output Area.

**Digital Input Lines**



- NOTE:** When using the UDP protocol:
- The User Socket Client Port is bound to the Server Port.
  - The maximum size for maintaining a whole datagram is 1436 bytes, messages exceeding this value will be fragmented.

<b>Trigger (Input 1) Echo</b>	Select <b>Disable</b> or <b>Enable</b> from the drop-down list. If enabled, the MSC 900 PS Input status is echoed to the Fieldbus Master via bit 0 in Byte 0 (LSB) of the Input Area.
<b>Aux (Input 3) Echo</b>	Select <b>Disable</b> or <b>Enable</b> from the drop-down list. If enabled, the MSC 900 PS AUX Input status is echoed to the Fieldbus Master via bit 2 in Byte 0 (LSB) of the Input Area.
<b>I/O 4 (Input 4) Echo</b>	Select Disable or Enable from the drop-down list.
<b>Phase Echo</b>	Select <b>Disable</b> or <b>Enable</b> from the drop-down list. If enabled, the MSC 900 Reading Phase status is echoed to the Fieldbus Master via bit 7 in Byte 0 (LSB) of the Input Area. This parameter is only available if Start Input from Bus is enabled.

**Digital Input Lines**

<b>Control Output 1-4</b>	Select <b>Disable</b> or <b>Enable</b> from the drop-down list. If enabled, it allows the Fieldbus Master to drive the numbered MSC 900 Controller Output via bit 0 in Byte 0 (LSB) of the Output Area.
---------------------------	---

3. When you have finished making changes, click **Update** to save or click **Reset** to revert to the previously saved values.

### 3.5.7 Modify Settings | Global Settings | Messaging

Use the Messaging selections during initial setup to configure system messaging for your system. If necessary, you can later make modifications to the configuration using the same menu selections, including:

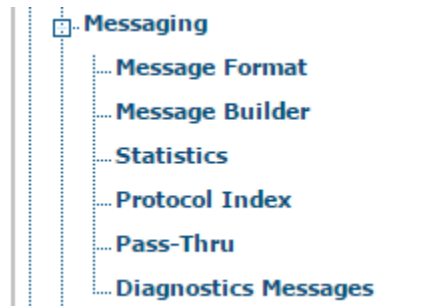

#### Modify Settings | Global Settings | Messaging | Message Format

Use the **Message Format** window to configure Standard or Advanced system messages.

**To edit the Message Format settings:**

1. In the tree menu under **Modify Settings**, navigate to **Global Settings | Messaging | Message Format**. The Message Format window opens.

 A screenshot of the 'Messaging Formatting' window. At the top, there is a 'Message Format' dropdown menu set to 'Standard'. Below this is a 'Standard Format' section containing several configuration fields:
 

- 'Header String (max. 128 chars)' with a text input field containing '<STX>' and an edit icon.
- 'Termination String (max. 128 chars)' with a text input field containing '<CR><LF>' and an edit icon.
- 'Data Packet Separators (max. 128 chars)' with a text input field containing '<CR><LF>' and an edit icon.
- 'Code Position Tx' with a disabled checkbox.
- 'Code Direction Identifier Enable' with a disabled checkbox.
- 'Code Field Length Setting' with a dropdown menu set to 'Fixed Length'.
- 'Code Field Length' with a text input field containing '0'.
- 'Data Justification' with a dropdown menu set to 'Left'.
- 'Fill Character' with a text input field containing '<SPC>' and an edit icon.
- 'Code Identifier' with a dropdown menu set to 'Disabled'.

 At the bottom of the window are two buttons: 'Update' and 'Reset'.

2. Enter the appropriate information in the form as described below:

**Messaging Formatting**

**Message Format** Select **Standard** or **Advanced** from the **Format Type** drop-down list.

**Message Tx Selection** Select **On Decoding** or **After Reading Phase Off** from the drop-down list. **Message Tx Selection** selects the transmission of the output message on decoding or after the reading phase as illustrated below.

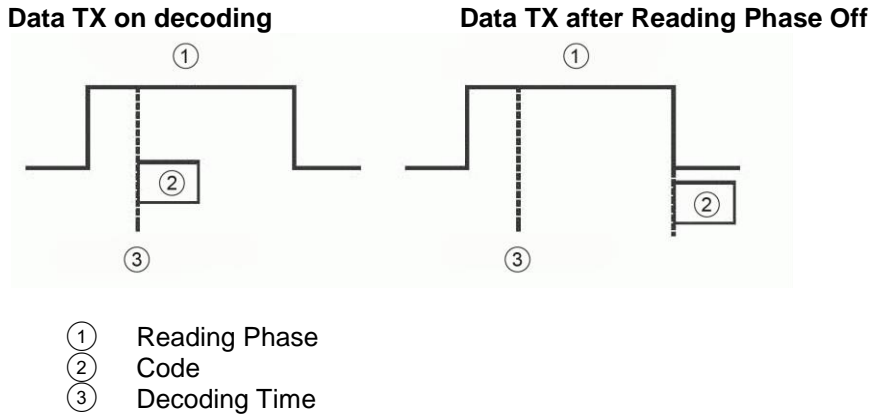

**NOTE:** This option is only available when an **Operating Mode** of **On Line** is selected in **Modify Settings | Global Settings | Operating Mode**.

**Max. Tx Delay after Phase Off** Select **Disabled** or a millisecond value (50 to 500 msec) from the drop-down list. This parameter defines a timeout, which is the maximum delay allowable for message transmission after the reading phase is closed. If this timeout expires before message transmission, the message will be discarded.

**NOTE:** This option is only available when an **Operating Mode** of **On Line** is selected in **Modify Settings | Global Settings | Operating Mode**.

**Header Tx Start** Select **With Data** or **After Reading Phase On** from the drop-down list. If **With Data** is selected, the header will be transmitted with data. If **After Reading Phase On** is selected, the header will be transmitted after the reading phase activation. See illustration below:

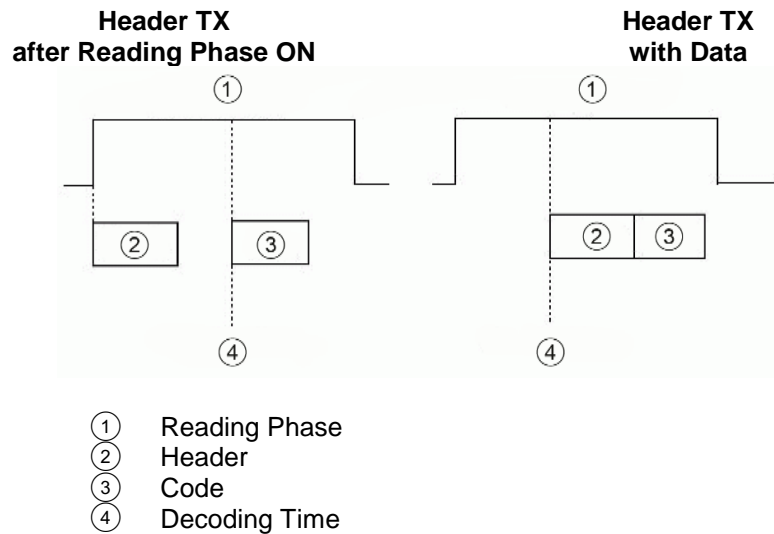

**NOTE:** This option is only available when an **Operating Mode** of **On Line** is selected in **Modify Settings | Global Settings | Operating Mode**.

**Termination After No Read Message** Select **Enable** or **Disable** from the drop-down list. If **Enable** is selected, a termination string is added to the No Read message string.







**NOTE:** This option is only available when an **Operating Mode** of **On Line** is selected in **Modify Settings | Global Settings | Operating Mode**.

#### Format Type: Standard

**Header String (max. 128 chars)** Click to activate the **Text Entry Tool** and create a **Header String** in the text field provided. Headers (up to 128 bytes) can be defined and transmitted as a block preceding the barcode(s). Use characters from NUL (00H) to ~ (7EH).

Click **Submit** to save your text to the origin window text field, or click **Cancel** to return to origin window without transferring text.

**Termination String (max. 128 chars)** Click to activate the **Text Entry Tool** and create a **Termination String** in the text field provided. Terminators (up to 128 bytes) can be defined and transmitted as a block following the barcode(s). Use characters from NUL (00H) to ~ (7EH). Click **Submit** to save your text to the origin window text field, or click **Cancel** to return to origin window without transferring text.

<b>Data Packet Separators (max. 128 chars)</b>	Click  to activate the <b>Text Entry Tool</b> and create a <b>Data Packet Separators</b> in the text field provided. The <b>Data Packet Separators</b> (up to 128 bytes) are used to separate barcodes in the reading phase. Use characters from NUL (00H) to ~ (7EH).
	For this reason, it is very useful when the <b>Standard Multi Label, Code Collection or Code Combination</b> parameters have been selected in the <b>Barcode Configuration</b> . If selected, they occur within the <b>Code Field</b> and are transmitted after each decoded code.
	Click <b>Submit</b> to save your text to the origin window text field, or click <b>Cancel</b> to return to origin window without transferring text.
<b>Code Position Tx</b>	Select the check box to enable. If enabled, the code position information is included in the output data format.
<b>Code Direction Identifier Enable</b>	Select the check box to enable. If enabled, it allows you to define the forward and reverse strings indicating the scanning direction with respect to the code direction.
<b>Forward Direction String (max. 32 chars)</b>	Click  to activate the <b>Text Entry Tool</b> and create a <b>Forward Direction String</b> in the text field provided. A <b>Forward Direction String</b> can be included in the output message to indicate that the current code has been scanned in the forward direction (scanning from left to right).
	This string ("+" is the default value) can be customized by the user including up to 32 characters.
	Click <b>Submit</b> to save your text to the origin window text field, or click <b>Cancel</b> to return to origin window without transferring text.
<b>Reverse Direction String (max. 32 chars)</b>	Click  to activate the <b>Text Entry Tool</b> and create a <b>Reverse Direction String</b> in the text field provided. A <b>Reverse Direction String</b> can be included in the output message to indicate that the current code has been scanned in the reverse direction (scanning from right to left).
	The string ("-") is the default value) can be customized by the user including up to 32 characters.
	Click <b>Submit</b> to save your text to the origin window text field, or click <b>Cancel</b> to return to origin window without transferring text.
<b>Unknown Direction String (max. 32 chars)</b>	Click  to activate the <b>Text Entry Tool</b> and create an <b>Unknown Direction String</b> in the text field. An <b>Unknown Direction String</b> can be included in the output message when it is not possible to determine the scanning direction of a code.
	The string ("?" is the default value) can be customized by the user including up to 32 characters.
	Click <b>Submit</b> to save your text to the origin window text field, or click <b>Cancel</b> to return to origin window without transferring text.
<b>Code Field Length Setting</b>	Select <b>Variable</b> or <b>Fixed</b> from the drop-down list. If <b>Variable</b> is chosen, all possible code field lengths (in number of characters/digits) allowed for the code selected are accepted. If <b>Fixed</b> is chosen, only the length defined by the Code Field Length parameter is accepted.

**Code Field Length** This parameter is only available when **Fixed** is selected as the **Code Field Length Setting**. Enter length of the code field to be transmitted (in number of characters/digits) in the field provided.

**Data Justification** This parameter is only available when **Fixed** is selected as the **Code Field Length Setting**. Select **Left** or **Right** from the drop-down list to define the position of the Fill Character within the code.

**Fill Character** This parameter is only available when **Fixed** is selected as the **Code Field Length Setting**. Click  to activate the **Text Entry Tool** and create a **Fill Character(s)**. The **Fill Character** is inserted into each character position of a code field that has more characters (as defined in the **Code Field Length**) than exist in the barcode read. Use characters from NUL (00H) to ~ (7EH).

**Example:**

For barcode "12345" with Fill Character "-" (2DH) and Code Field Length of 10 characters, the result of the different alignment will be:

Left aligned = <Code Identifier><12345----->...  
 Right aligned = <Code Identifier><-----12345>...

Click **Submit** to save your text to the origin window text field, or click **Cancel** to return to origin window without transferring text.

**Code Identifier** Select **Disable**, **Standard AIM ID**, or **User Specified** from the drop-down list. A **Code Identifier** string can be included in the output message.



















- If **Disable** is selected, no code identifier is included in the output message.
- If **Standard AIM ID** is selected, the AIM standard identifier is included in the output message
- If **User Specified** is selected, the **Code Identifier Strings** group is activated at the bottom of the window, allowing you to define an identifier string for each code symbology. The string will be included in the output message.

### Code Identifier Strings

This section of the Message Format window is only available when **User Specified** is selected as the **Code Identifier**. Click  to activate the Text Entry Tool and create a custom code identifier string for any listed code symbology. Click **Submit** to save your text to the origin window text field, or click **Cancel** to return to origin window without transferring text.

Code Identifier
User Specified ▼

**Code Identifier Strings (max 32 chars)**

Code 128 Identifier String	<input type="text" value="]C0"/>	
Interleaved 2/5 Identifier String	<input type="text" value="]I0"/>	
Code 39 Identifier String	<input type="text" value="]A0"/>	
Code 93 Identifier String	<input type="text" value="]G0"/>	
Codabar Identifier String	<input type="text" value="]F0"/>	
GS1-128 (ex EAN128) Identifier String	<input type="text" value="]C1"/>	
EAN13 Identifier String	<input type="text" value="]E0"/>	
EAN13 + Add-on 2 Identifier String	<input type="text" value="]E1"/>	
EAN13 + Add-on 5 Identifier String	<input type="text" value="]E2"/>	
EAN-8 Identifier String	<input type="text" value="]E4"/>	
EAN-8 + Add-on 2 Identifier String	<input type="text" value="]E5"/>	
EAN-8 + Add-on 5 Identifier String	<input type="text" value="]E6"/>	
UPC-A Identifier String	<input type="text" value="]E0"/>	
UPC-A + Add-on 2 Identifier String	<input type="text" value="]E1"/>	
UPC-A + Add-on 5 Identifier String	<input type="text" value="]E2"/>	
UPC-E Identifier String	<input type="text" value="]E7"/>	
UPC-E + Add-on 2 Identifier String	<input type="text" value="]E8"/>	
UPC-E + Add-on 5 Identifier String	<input type="text" value="]E9"/>	



## Format Type: Advanced

**Select a Message Number to Modify** Select a numbered message you wish to modify from the drop-down list.

Advanced Format: Message Definition *n*

**Message Destination** Select the check box for each port or socket that should receive the message.

**Message Destination Bitmap** Indicates the destination of the message.



**Message Alignment** Select None, Left, or Right from the drop-down list.

**Align Length** Enter the number of characters by which to extend the message when **Left** or **Right** is selected from the **Message Alignment** drop-down box.

**Align Filler Char** Click  to activate the **Text Entry Tool** and create a filler character in the text field provided. This filler is used to extend the **Align Length**.

**Header** Click  to activate the **Text Entry Tool** and create a **Header** in the text field provided. Headers (up to 128 bytes) can be defined and transmitted as a block preceding the barcode(s). Use characters from NUL (00H) to ~ (7EH).

Click **Submit** to save your text to the origin window text field, or click **Cancel** to return to origin window without transferring text.

- Terminator** Click  to activate the Text Entry Tool and create a **Terminator** in the text field provided. Terminators (up to 128 bytes) can be defined and transmitted as a block following the barcode(s). Use characters from **NUL** (00H) to **~** (7EH).
- Click **Submit** to save your text to the origin window text field, or click **Cancel** to return to origin window without transferring text.
- 
- Global No Read Type** Select **Only No Read**, **Left**, or **Right** from the drop-down list.
- 
- Global Scale Type (Units)** Select **Metric (mm)** or **Imperial (0.1 in)** from the drop-down list.
- 
- Code Identifier** Select **Disable**, **Standard AIM ID**, or **User Specified** from the drop-down list. A **Code Identifier** string can be included in the output message.
- If **Disable** is selected, no code identifier is included in the output message.
  - If **Standard AIM ID** is selected, the AIM standard identifier is included in the output message
  - If **User Specified** is selected, the **Code Identifier Strings** group is activated at the bottom of the window, allowing you to define an identifier string for each code symbology. The string will be included in the output message.
- Code Identifier Strings**
- This section of the Message Format window is only available when **User Specified** is selected as the **Code Identifier**. Click  to activate the **Text Entry Tool** and create a custom code identifier string for any listed code symbology.
- Click **Submit** to save your text to the origin window text field, or click **Cancel** to return to origin window without transferring text.
- 
3. When you have finished making changes, click **Update** to save or click **Reset** to revert to the previously saved values.

## Modify Settings | Global Settings | Messaging | Message Builder

Use the **Message Builder** window to create Standard or Advanced system messages.

**To use the Message Builder:**

1. In the tree menu under Modify Settings, navigate to **Global Settings | Messaging | Message Builder**. The **Message Builder** window opens.

2. Enter the appropriate information in the form as described below:

Field Name	Action/Definition
<b>Message Number to Modify</b>	Select the number of the message you want to modify from the drop-down list.
<b>Message <i>n</i> Item List</b>	
<b>Idx</b>	Displays the index number of the messages.
<b>Type</b>	Displays the message type including various <b>Text String</b> , <b>Code Related Item</b> , or <b>Package Related</b> Item messages.
<b>Qualifier</b>	Displays relevant qualifiers for the message item if needed.
<b>Add</b>	Click to add a message item to the bottom of the list.
<b>Add before</b>	Click to add a message item above the currently selected message.
<b>Add after</b>	Click to add a message item below the currently selected message.

---

**Move up** Click to move the selected message item up one level in the list.

---

**Move down** Click to move the selected message item down one level in the list.

---

**Remove** Click to remove the selected message item.

---

#### Item *n* Definition

---

**Item Type** Select **Text String**, **Code Related Item**, or **Package Related Item** from the drop-down list. Each selection reveals a unique set of options.

**String Field** Click  to activate the **Text Entry Tool** and create a text string message. This option is available when Item **Type > Text String** has been selected.

Click **Submit** to save your text to the origin window text field, or click **Cancel** to return to origin window without transferring text.

---

**Code Related Items** Select a code related item from those available in the drop-down list. This option is available when Item **Type > Code Related Item** has been selected. The **Code Related Items** can be associated to a specific programmed code or group label depending on the Code Combination selection.

**Selections Include:**

- **Barcode:** Barcode data
  - **Barcode Length:** Number of characters in code
  - **Read Bitmap:** 32-bit mask indicating which scanner in the network has read the code (when character <1> is present in the related position)
  - **Total Read Count:** Indicates how many times the code has been read by all scanners present in the network during the same reading phase
  - **Read Count (by device):** Indicates the number of times the code has been read by one specific scanner present in the network during the reading phase (selectable among those present)
  - **X Position:** X coordinate for the code that was read
  - **Y Position:** Y coordinate for the code that was read
  - **Z Position:** Z coordinate for the code that was read
  - **Code Identifier:** Indicates type of code that was read
  - **Code Direction:** Indicates if the code has been read either from either the start character or the stop character
  - **Code Distance:** Indicates the distance to the code that was read
  - **Decode Mode:** Indicates if the code has been read using Linear or Reconstruction (ACR) reading mode
  - **Decode Scans Number:** Indicates the minimum number of decoded scans referred to the single characters in a code when the device is reading in Reconstruction mode. This Item can be used as Code Quality Index
-

- **Average Code Position:** Average position of the code in the scan line (Average of Minimum and Maximum Code Position)
- **Minimum Code Position:** Minimum position of the code in the scan line (closest to the left side/connector side of the scanner)
- **Maximum Code Position:** Maximum position of the code in the scan line (farthest from the left side/connector side of the scanner)
- **Ink Spread:** Indicates the calculated Ink Spread value
- **Encoder Value:** Indicates the encoder/tachometer pulse value from trigger to the code being read
- **Laser Number:** If more than one laser is present in the working device, this item indicates the laser used to read the code
- **Reading Persistence:** Indicates how many times the laser beam has crossed the complete code during the reading phase

---

**Package  
Related Item**

Select a package related item from those available in the drop-down list. This option is available when Item Type > Package Related Item has been selected.

**Selections Include:**

- **Package Sequence Number:** Indicates the sequential number assigned to the package.
- **Total Read Bitmap:** Indicates the complete reading mask related to all codes read during the reading phase
- **Failure Bitmap:** 32-bit mask indicating which devices in the network are in fault (when character <1> is present in the related position)
- **Total Read Count:** Indicates the sum of all Code-related Total Reading Counts of each code read during the reading phase
- **Read Count (by device):** Indicates the number of codes read during the reading phase by the device
- **Minimum Code Distance:** Indicates the distance of the code closest to the device read during the reading phase
- **Maximum Code Distance:** Indicates the distance of the code most distant from the scanner that has been read during the reading phase
- **Decode Mode (Master):** Indicates the programmed Reading Mode, either Linear or Reconstruction
- **Number of Rejected Codes:** Indicates the number of codes rejected during the internal analysis (unexpected code, multiple read, discarded by the programmed logical rule)
- **Package Length:** Indicates the approximate length of the package
- **Start Trigger Encoder Value:** Indicates the encoder/tachometer pulse value when the package first hits the trigger PS

- **End Trigger Encoder Value:** Indicates the encoder/tachometer pulse value when the package exits the trigger PS
- **Transmit Encoder Value:** Indicates the encoder/tachometer pulse value when the data transmit occurs
- **Current Trigger Count:** Indicates the number of trigger cycles that have occurred
- **Working Hours (By Device):** Indicates the total number of hours the device has been active
- **Total Good Reads:** Indicates the total number of barcodes successfully read
- **Total No Reads:** Indicates the total number of barcodes that were not read
- **Total Multi Reads:** Indicates the number of times packages carried more codes than the scanner is programmed to read
- **Total Partial Reads:** Indicates the total number of barcodes only partially read
- **Protocol Index:** Indicates the programmed protocol index string data

**Code/Group Selection** Select a Code/Group from those available in the drop-down list. This option is available when Item **Type > Code Related Item** has been selected.

**Device Index** Select a device index number from the drop-down list. This option is available when Item **Type > Code Related Item > Read Count (By Device)** or **Type > Package Related Items > Read Count (By Device)/Working Hours (By Device)** has been selected.

**Text String: Options**

**Link to Code** Select Disabled, Previous Code, or Next Code from the drop-down list.

- **Disabled:** A code will not be linked to this text string
- **Previous Code:** The text string will be linked to the previous generated code
- **Next Code:** The text string will be linked to the next generated code

**Code Related Item or Package Related Item: Options**

**Item Alignment** Select **None**, **Left**, or **Right** from the drop-down list.

**Item Alignment Length** Enter an **Item Alignment Length** in the field provided.

**Item Alignment Filler** Click  to activate the **Text Entry Tool** and create filler text. Click **Submit** to save your text to the origin window text field, or click **Cancel** to return to origin window without transferring text.

**Item Data Size** Select **Variable** or a number of digits to use from the drop-down list.

**Item Data Format** Select **Decimal (ASCII)**, **Hexadecimal (ASCII)**, **Bitmap (ASCII)**, or **Numeric (Binary)** from the drop-down list.

3. When you have finished making changes, click **Update** to save or click **Reset** to revert to the previously saved values.

## Modify Settings | Global Settings | Messaging | Statistics

Use the **Statistics** window to select the desired statistical counters, making up the statistics field, and relative statistics field separator string to be sent to the system by the Stand Alone or Master scanner.

To edit the **Statistics** settings:

1. In the tree menu under **Modify Settings**, navigate to **Global Settings | Messaging | Statistics**. The Statistics window opens.

2. Enter the appropriate information in the form as described below:

Field Name	Action/Definition
------------	-------------------

<b>Enable</b>	Select the check box to reveal and edit statistic message options. The selections correspond to the message as shown below:
---------------	---

<b>Separator</b>	Click  to activate the <b>Text Entry Tool</b> and create a <b>Separator</b> in the text field provided. <b>Separator</b> strings (up to 32 bytes) can be created and will be inserted between the last code and the first statistical counter.
------------------	--

Click **Submit** to save your text to the origin window text field, or click **Cancel** to return to origin window without transferring text.

**Time** Select the check box to include the time counter in the statistical message, reporting the time elapsed in hours and minutes (H MM) from the last hardware reset.

---

**Trigger Counter** Select the check box to reports the total number of trigger sessions (reading phases) from the last hardware reset.

---

**Good Read Counter** Select the check box to report the total number of good reads from the last hardware reset.

---

**No Read Counter** Select the check box to report the total number of no reads from the last hardware reset.

---

**Multiple Read Counter** Select the check box to report the total number of multiple reads from the last hardware reset.

---

3. When you have finished making changes, click **Update** to save or click **Reset** to revert to the previously saved values.



## Modify Settings | Global Settings | Messaging | Protocol Index

Use the **Protocol Index** window to configure Protocol Index parameters. Protocol Index allows the Host to transmit a string that it has associated to a pack contained within the tracking area.

It is possible to manage several different Protocol Index messages (one per available communication interface), within the same reading phase (for the same pack). If more than one Index message is received on the same communication interface, only the last one will be accepted.

These strings will be received by the MSC 900 and included within its output message according to the following order:

1. Built-In Ethernet User Socket 1
2. Built-In Ethernet User Socket 2
3. Built-In Ethernet User Socket 3
4. Auxiliary Serial Port
5. Main Serial Port

**The general output format is:** <Header>Index1<Data Packet Separator>...IndexN<Data Packet Separator>Standard Message<Terminator>

**The Index field has the following format:** <Index Header>Index Message<Index Terminator>



**NOTE:** This parameter is only available for scanners configured as **Standalone** or as **Master** when working in **On Line** or **PackTrack™** operating modes.

In **On Line** mode, the Protocol Index must arrive during the active reading phase otherwise it will be discarded.

- If the Distance from Protocol Index to Trigger Line parameter = 0, the Protocol Index must arrive during the active reading phase otherwise it will be discarded.

In PackTrack™ mode:

- If the Distance from Protocol Index to Trigger Line parameter is not = 0, the Protocol Index will arrive at the specified distance.

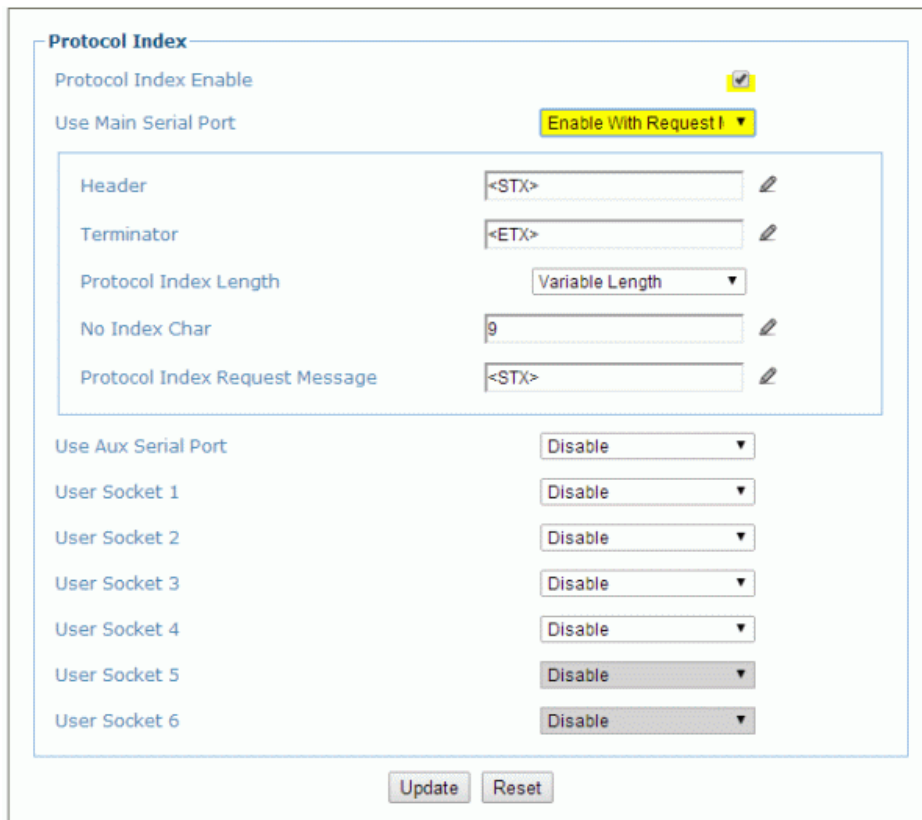

**To edit the Protocol Index settings:**

1. In the tree menu under Modify Settings, navigate to **Global Settings | Messaging | Protocol Index**. The Protocol Index window opens.



2. Enter the appropriate information in the form as described below:

Field Name	Action/Definition
<b>Protocol Index Enable</b>	Select the check box to reveal and edit <b>Protocol Index</b> options.
<b>Use Main Serial Port</b>	Select <b>Disable</b> , <b>Enable without Request Message</b> , or <b>Enable with Request Message</b> from the drop-down list. <ul style="list-style-type: none"> <li>• <b>Disable:</b> The selected communication channel is not used for Protocol Index string communication.</li> <li>• <b>Enable without Request Message:</b> The Host sends the Protocol Index string autonomously on the selected communication channel.</li> <li>• <b>Enable with Request Message:</b> The Host waits for the Protocol Index Request Message sent by the scanner, when the trigger detects the presence of a pack, before transmitting the Protocol Index string associated to the pack itself on the selected communication channel.</li> </ul>
<b>Header</b>	Click  to activate the <b>Text Entry Tool</b> and create a <b>Header</b> (up to 128 bytes) to be defined and transmitted as a block preceding the <b>Protocol Index</b> string sent by the Host. Use characters from NUL (00H) to ~ (7EH). <p>Click <b>Submit</b> to save your text to the origin window text field, or click <b>Cancel</b> to return to origin window without transferring text.</p>

<b>Terminator</b>	Click  to activate the <b>Text Entry Tool</b> and create a <b>Terminator</b> to be defined and transmitted as a block following the Protocol Index string sent by the Host. Use characters from NUL (00H) to ~ (7EH).
Click <b>Submit</b> to save your text to the origin window text field, or click <b>Cancel</b> to return to origin window without transferring text.	
<b>Protocol Index Length</b>	<p>Select Length in Message, Variable Length, or a length of 3 through 12 from the drop-down list.</p> <ul style="list-style-type: none"> <li>• <b>Length in Message:</b> The first byte of the scanner output message indicates the length of the Protocol Index string sent by the Host.</li> <li>• <b>Variable Length:</b> The length of the Protocol Index string sent by the Host is variable.</li> <li>• <b>3...12:</b> The Protocol Index string has a fixed length from 3 to 12 characters.</li> </ul>
<b>No Index Char</b>	Click  to activate the <b>Text Entry Tool</b> and create a <b>No Index Char</b> . Click <b>Submit</b> to save your text to the origin window text field, or click <b>Cancel</b> to return to origin window without transferring text.
<b>Protocol Index Request Message</b>	Click  to activate the <b>Text Entry Tool</b> and create a <b>Protocol Index Request Message</b> . Click <b>Submit</b> to save your text to the origin window text field, or click <b>Cancel</b> to return to origin window without transferring text.
<b>Distance from Protocol Index to Trigger Line (mm)</b>	<p>Enter a distance in millimeters in the field provided.</p> <p>When the <b>Use Main Serial Port</b> parameter of the selected interface port is set to <b>Enable without Request Message</b>, this parameter specifies the distance from the Trigger Line (i.e. Presence Sensor) to the expected receiving point of the Protocol Index, measured in mm. If set to 0 the Protocol Index must arrive during the active reading phase otherwise it will be discarded.</p>
<b>Use Aux Serial Port / User Socket <i>n</i></b>	Select <b>Disable</b> , <b>Enable without Request Message</b> , or <b>Enable with Request Message</b> from the drop-down list. Then enter the parameters as described for <b>Use Main Serial Port</b> above.

- When you have finished making changes, click **Update** to save or click **Reset** to revert to the previously saved values.

## Modify Settings | Global Settings | Messaging | Pass-Thru

Use the **Pass-Thru** window to pass a message received on ANY port (serial or user socket connection) to any other port(s).

Applications can also be implemented to connect a device such as a hand-held reader to any serial or network port for additional manual code reading capability.

When using Pass-Thru mode, follow these programming notes:

- When using serial ports – Program receiving port same way regarding baud rate, data bits, stop bits and parity to the device sending the data.
- The Termination string must be configured in the same way as the message terminator on the device sending the data. The terminator will be forwarded with the message.

### To edit the Pass-Thru settings:

1. In the tree menu under **Modify Settings**, navigate to **Global Settings | Messaging | Pass-Thru**. The Pass-Thru window opens.

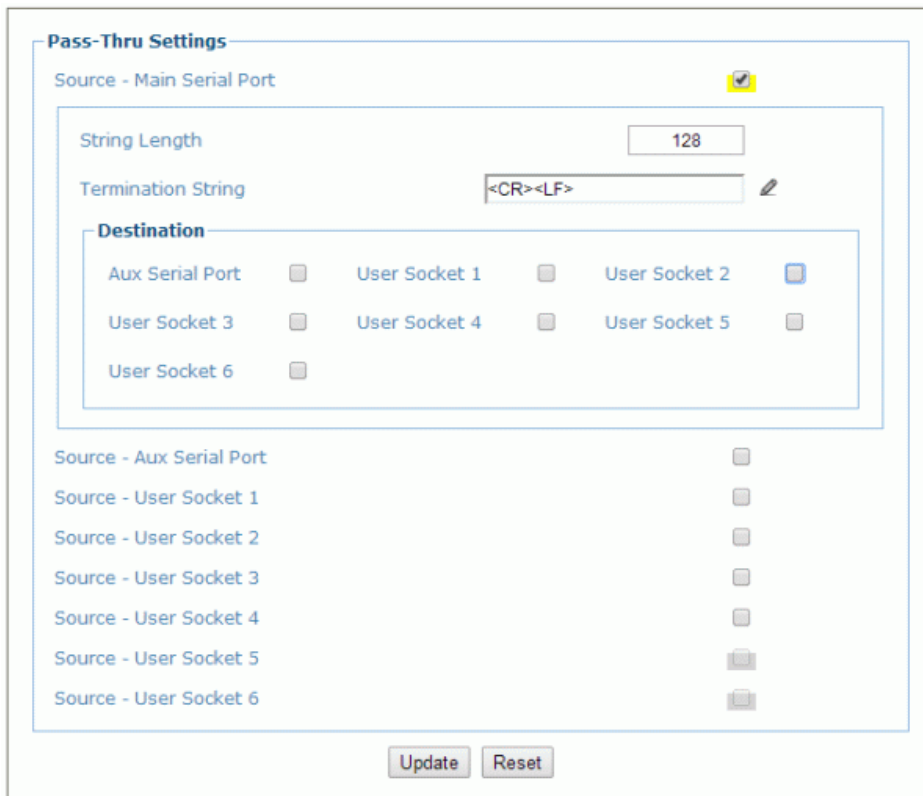

2. Enter the appropriate information in the form as described below:

Field Name	Action/Definition
Source	Select the check box(es) following the <b>Main Serial Port</b> , <b>Aux Serial Port</b> , or numbered <b>User Socket</b> you wish to modify.

**String Length** Enter the maximum length of the expected string to be received. If the string is longer than the one expected, it will be discarded.

---

**Termination String** Click  to activate the Text Entry Tool to define the characters terminating the expected string. Click **Submit** to save your text to the origin window text field, or click **Cancel** to return to origin window without transferring text.

---

**Destination** Select the check box next to the destination(s) to be used for the Pass-Thru.

---

3. When you have finished making changes, click **Update** to save or click **Reset** to revert to the previously saved values.

## Modify Settings | Global Settings | Messaging | Diagnostics Messages

Use the **Diagnostic Message** window to select the parameters managing diagnostic message transmission by the **Stand Alone** or **Master** scanner.

To edit the **Diagnostic Message** settings:

1. In the tree menu under **Modify Settings**, navigate to **Global Settings | Messaging | Diagnostic Message**. The Diagnostic Message window opens.

2. Enter the appropriate information in the form as described below:

Field Name	Action/Definition
<b>Transmit Mode</b>	Select <b>On Timeout</b> or <b>With Code</b> from the drop-down list. The diagnostic message can be transmitted to the system by the <b>Stand Alone</b> or <b>Master</b> barcode scanner either asynchronously (at programmed intervals), or synchronously with the code.
<b>Tx Refresh</b>	Select a <b>TX Refresh</b> rate in seconds or minutes from the drop-down list to define the time interval in which the diagnostic messages will be transmitted if <b>Tx Mode</b> is asynchronous (On Timeout).
<b>Message Position</b>	Select <b>Append to Code</b> or <b>Replace Code</b> from the drop-down list. If <b>Transmit Mode</b> is synchronous (With Code), the diagnostic messages will be transmitted on the same interface used for code transmission. This selection determines if the messages will replace the code or be appended to it.

**Error Messages**

Transmit Mode

With Code

Message Position

Append to Code

**Message Format****Header String**

Click  to activate the **Text Entry Tool** to define the header string (up to 128 characters) as a block preceding the diagnostic message. Use characters from NUL (00H) to ~ (7EH).

Click **Submit** to save your text to the origin window text field, or click **Cancel** to return to origin window without transferring text.

**Terminator String**

Click  to activate the **Text Entry Tool** to define the terminator string (up to 128 characters) as a block following the diagnostic message. Use characters from NUL (00H) to ~ (7EH).

Click **Submit** to save your text to the origin window text field, or click **Cancel** to return to origin window without transferring text.

**Error Message Type**

Select **Numeric** or **Global String** from the drop-down list to define how the message will be sent.

**Global String (max. 32 chars)**

Click  to activate the **Text Entry Tool** to define the **Global String** message (up to 32 bytes) that will be sent as a diagnostic message for any detected diagnostic error.

Click **Submit** to save your text to the origin window text field, or click **Cancel** to return to origin window without transferring text.

**Destination**

Select the check box next to the destination(s) to be used for the diagnostic messages.

**PackTrack Messages****PackTrack Debug Message Enable**

Select the checkbox to enable debug messages for PackTrack. If selected, this parameter allows transmitting messages concerning the system functioning.

**PackTrack Debug Message Port**

Select **Main Serial**, **Aux Serial**, or **Socket n** from the drop-down list. The debug message will be transmitted through the selected port.

**PackTrack Debug Message Digital Input**

Select None, Trigger (Input 1), Aux (Input 3), or I/O 4 (Input 4) from the drop-down list. This selection defines which digital input will be used to trigger debug message transmission.

- When you have finished making changes, click **Update** to save or click **Reset** to revert to the previously saved values.

### 3.5.8 Modify Settings | Global Settings | Digital I/O

Use the **Digital I/O** window to configure the digital inputs and outputs for your barcode scanning system.

To edit the **Digital I/O** settings:

1. In the tree menu under **Modify Settings**, navigate to **Global Settings | Digital I/O**. The Digital I/O window opens.

2. Enter the appropriate information in the form as described below:

Field Name	Action/Definition
<b>Bidirectional Line Setup (MSC 900 Controller Only)</b>	

<b>I/O 4 Direction</b>	Select Input or Output from the drop-down list.
------------------------	---



### Digital Input Lines

**Trigger (Input 1) Active Level** Select **Active Closed** or **Active Open** from the drop-down list.

- **Active Closed:** Input 1 is active when current flows through (IN1) EXT\_TRIG pins.
- **Active Open:** Input 1 is active when there is no current flowing through (IN1) EXT\_TRIG pins.



This parameter setting is not valid, if the input has already been defined in **On Line** or **PackTrack™ Operating Modes**.

**Aux (Input 3) Active Level** Select **Active Closed** or **Active Open** from the drop-down list.

- **Active Closed:** Input 3 is active when current flows through IN3 pins.
- **Active Open:** Input 3 is active when there is no current flowing through IN3 pins.



NOTE: This parameter setting is not valid, if the input has already been defined in **On Line** or **PackTrack™ Operating Modes**.

### Digital Output Lines

**Select Digital Output Number to View/Modify** Select the number of the output you will view or modify from the drop-down list.

### Digital Output *n*

**Digital Output *n* Use** Select **Local**, **EthernetIP**, or **Profibus/Profinet** from the drop-down list.

**Digital Output *n* Line State** Select **Normally Open** or **Normally Closed** from the drop-down list.

Each output can be represented with an **NPN** transistor; this transistor acts like a switch: so, when the transistor is **OFF**, it acts like an **OPEN** switch. On the contrary, when the transistor is **ON**, it acts like a **CLOSED** switch.

- **Normally Open:** The idle state of the output line is open, that is, the **NPN** transistor is **OFF** (like an open switch). When the output is activated, the transistor goes **ON** (like a closed switch).
- **Normally Closed:** The idle state of the output line is closed, that is, the **NPN** transistor is **ON** (like a closed switch). When the output is activated, the transistor goes **OFF** (like an open switch).

**Activation**

**Primary Activation Event** Select a **Primary Activation Event** from the drop-down list (see below).

- **None:** The output is always in line state.
- **Complete Read:** The event occurs, if all selected codes are read.
- **Partial Read:** The event occurs, if less than the selected codes are read.
- **No Read:** The event occurs, if no code is read.
- **Trigger On:** The event occurs, when a start event takes place starting the reading phase.
- **Trigger Off:** The event occurs, when a stop event takes place ending the reading phase.
- **Multiple Read:** The event occurs, if a code is read more than once consecutively.
- **Right/Match:** The event occurs, if a code is successfully decoded and matches the Match Code (Verifier Code).
- **Wrong/No Match:** The event occurs, if a code is successfully decoded but does not match the Match Code (Verifier Code).

**Secondary Activation Event** Select a **Secondary (Alternate) Activation Event** from the drop-down list (see below).

- **None:** The output is always in line state.
- **Complete Read:** The event occurs, if all selected codes are read.
- **Partial Read:** The event occurs, if less than the selected codes are read.
- **No Read:** The event occurs, if no code is read.
- **Trigger On:** The event occurs, when a start event takes place starting the reading phase.
- **Trigger Off:** The event occurs, when a stop event takes place ending the reading phase.
- **Multiple Read:** The event occurs, if a code is read more than once consecutively.
- **Right/Match:** The event occurs, if a code is successfully decoded and matches the Match Code (Verifier Code).
- **Wrong/No Match:** The event occurs, if a code is successfully decoded but does not match the Match Code (Verifier Code).

**Activate On Error** Select **Disable** or **Enable** from the drop-down list. If this parameter is enabled, the output will activate when a diagnostic error message is sent.



**NOTE:** When using this parameter, all other activation events should be set to **None**.

**Deactivation**

**Primary Deactivation Event** Select a **Primary Deactivation Event** from the drop-down list (see below).

- **None:** A deactivation event is NOT defined.
- **Timeout:** Indicates the maximum duration of the output pulse. When selected, the Deactivation Timeout text field is revealed.
- **Trigger On:** The event occurs, when a start event takes place

starting the reading phase.

- **Trigger Off:** The event occurs, when a stop event takes place terminating the reading phase.

**Secondary Deactivation Event** Select a **Secondary (Alternate) Deactivation Event** from the drop-down list (see below).

- **None:** A secondary deactivation event is NOT defined.
- **Trigger On:** The event occurs, when a start event takes place starting the reading phase.
- **Trigger Off:** The event occurs, when a stop event takes place terminating the reading phase.

**Deactivate On Clear Error** Select **Disable** or **Enable** from the drop-down list. If this parameter is enabled, the output will deactivate when the error is no longer present.

**Deactivation Timeout** Enter the maximum duration of the output pulse in the text field provided. Input a value from **40** to **15000 milliseconds**.

3. When you have finished making changes, click **Update** to save or click **Reset** to revert to the previously saved values.

### 3.5.9 Modify Settings | Global Settings | Diagnostics

Use the **Diagnostics** window to configure the digital inputs and outputs for your barcode scanning system.

**To edit the Diagnostics settings:**

1. In the tree menu under **Modify Settings**, navigate to **Global Settings | Diagnostics**. The Diagnostics window opens.

**Diagnostic Settings**

Sampling Time

Report Slave Scanner Diagnostics

**Errors To Report**

No Scan Signal Failure	<input checked="" type="checkbox"/>	In-the-beam Sensor Failure	<input checked="" type="checkbox"/>
APD Sensor Failure	<input checked="" type="checkbox"/>	Laser Failure	<input checked="" type="checkbox"/>
Motor Failure	<input checked="" type="checkbox"/>	Motor Warning	<input checked="" type="checkbox"/>
SD Card Failure	<input checked="" type="checkbox"/>		

PTP Time Synchronization Failure

Encoder Failure

Encoder Timeout

Presence Sensor Failure

No Phase Timeout

2. Enter the appropriate information in the form as described below:

Field Name	Action/Definition
<b>Sampling Time</b>	Select a <b>Sampling Time</b> in seconds or minutes from the drop-down list. This selection indicates the time lapse between system diagnostic queries.
<b>Report Slave Scanner Diagnostics</b>	Select the check box to report diagnostic information from the slave scanners in the system.
<b>Errors To Report</b>	Select the check box next to each error type the system should report.
<b>PTP Time Synchronization Failure</b>	Select the check box to report PTP (Precision Time Protocol) Time Synchronization Errors.
<b>Encoder Failure</b>	Select the check box to report encoder (tachometer) errors.
<b>Encoder Timeout</b>	Select <b>Disable</b> or a time interval in seconds or minutes from the drop-down list. If a time interval is selected, a stuck encoder will report an error after the selected interval.
<b>Presence Sensor Failure</b>	Select the check box to report presence sensor failure errors.
<b>No Phase Timeout</b>	Select <b>Disable</b> or a time interval in seconds or minutes from the drop-down list. If a time interval is selected, a stuck sensor will report an error after the selected interval.

3. When you have finished making changes, click **Update** to save or click **Reset** to revert to the previously saved values.

### 3.5.10 Modify Settings | Global Settings | Energy Saving

Use the **Energy Saving** window to activating/deactivate energy saving feature. In particular, it allows turning network scanner motors and lasers on or off according to specific conditions. It is suggested to use this parameter for example when the conveyor is stopped for a lengthy period.

**To view and edit the Energy Saving settings:**

1. In the tree menu under Modify Settings, navigate to Global Settings | Energy Saving. The Energy Saving window opens.

2. Enter the appropriate information in the form as described below:

Field Name	Action/Definition
<b>Energy Saving Configuration</b>	Select the check box to reveal <b>Energy Saving Configuration</b> options.
<b>Use Encoder For</b>	Select None, Deactivation, Activation, or Activation and Deactivation from the drop-down list. This parameter allows defining the function to be performed by an Encoder: <ul style="list-style-type: none"> <li>• <b>None:</b> No function is performed by the digital input.</li> <li>• <b>Deactivation:</b> The digital input is used to deactivate the Energy Saving. Thus, the motor and laser of all network scanners will be turned on.</li> <li>• <b>Activation:</b> The digital input is used to activate the Energy Saving. Thus, the motor and laser of all network scanners will be turned off.</li> <li>• <b>Activation and Deactivation:</b> The digital input is used to both activate and</li> </ul>

deactivate the Energy Saving. Thus, the motor and laser of all network scanners will be turned on/off.

**Activation Encoder Timeout** Select a minute value from the drop-down list. This parameter is available only when the encoder is used for the Energy Saving activation. If the encoder is stopped for more than the programmed timeout, the Energy Saving will be activated.

**Deactivation Encoder Timeout** Select a second or minute value from the drop-down list. This parameter is available only when the encoder is used for the Energy Saving deactivation. If the encoder runs for at least the programmed timeout, the Energy Saving will be deactivated.

**Use Digital Input For** Select **None**, **Deactivation**, **Activation**, or **Activation and Deactivation** from the drop-down list. This parameter allows defining the function to be performed by a digital input:

- **None:** No function is performed by the digital input.
- **Deactivation:** The digital input is used to deactivate the Energy Saving. Thus, the motor and laser of all network scanners will be turned on.
- **Activation:** The digital input is used to activate the Energy Saving. Thus, the motor and laser of all network scanners will be turned off.
- **Activation and Deactivation:** The digital input is used to both activate and deactivate the Energy Saving. Thus, the motor and laser of all network scanners will be turned on/off.

**Select Digital Input** Select a digital input from the drop-down list. This parameter defines the digital input to be used for activating/deactivating the Energy Saving.

**Select Input Type** Select **Edge** or **Level** from the drop-down list.

**Use Main Serial Port For** Select **None**, **Deactivation**, **Activation**, or **Activation and Deactivation** from the drop-down list. This parameter allows defining the function to be performed by Main Serial Port:

- **None:** No function is performed by the digital input.
- **Deactivation:** The digital input is used to deactivate the Energy Saving. Thus, the motor and laser of all network scanners will be turned on.
- **Activation:** The digital input is used to activate the Energy Saving. Thus, the motor and laser of all network scanners will be turned off.
- **Activation and Deactivation:** The digital input is used to both activate and deactivate the Energy Saving. Thus, the motor and laser of all network scanners will be turned on/off

**Header**  **NOTE:** This parameter is available only when a communication channel has been selected to perform a specific function.

Click  to activate the **Text Entry Tool** and create a **Header** (up to 128 bytes) to define a header (1 byte) and transmit it as a block preceding the activation/deactivation string sent to a Master or Stand Alone scanner. Use characters from NUL (00H) to ~ (7EH). Click **Submit** to save your text to the origin window text field, or click **Cancel** to return to origin window without transferring text.

**Terminator**  **NOTE:** This parameter is available only when a communication channel has been selected to perform a specific function.

Click  to activate the **Text Entry Tool** and create a **Terminator** to define a

terminator (1 byte) and transmit it as a block following the activation/deactivation string sent to the Master or Stand Alone scanner. Use characters from NUL (00H) to ~ (7EH). Click **Submit** to save your text to the origin window text field, or click **Cancel** to return to origin window without transferring text.

#### Activation String



**NOTE:** This parameter is available only when a communication channel has been selected to perform the Activation or Activation & Deactivation function.

Click  to activate the **Text Entry Tool** and create a string that defines the characters to be transmitted within the output message to activate the **Energy Saving**. Click **Submit** to save your text to the origin window text field, or click **Cancel** to return to origin window without transferring text.

#### Deactivation String



**NOTE:** This parameter is available only when a communication channel has been selected to perform the Deactivation or Activation & Deactivation function.

Click  to activate the **Text Entry Tool** and create a character string to be transmitted within the output message to deactivate the **Energy Saving**. Click **Submit** to save your text to the origin window text field, or click **Cancel** to return to origin window without transferring text.

#### Use Aux Serial Port For

Select **None**, **Deactivation**, **Activation**, or **Activation and Deactivation** from the drop-down list. This parameter allows defining the function to be performed by the Aux Serial Port:

- **None:** No function is performed by the digital input.
- **Deactivation:** The digital input is used to deactivate the Energy Saving. Thus, the motor and laser of all network scanners will be turned on.
- **Activation:** The digital input is used to activate the Energy Saving. Thus, the motor and laser of all network scanners will be turned off.
- **Activation and Deactivation:** The digital input is used to both activate and deactivate the Energy Saving. Thus, the motor and laser of all network scanners will be turned on/off.

#### Header



**NOTE:** This parameter is available only when a communication channel has been selected to perform a specific function.

Click  to activate the **Text Entry Tool** and create a **Header** (up to 128 bytes) to define a header (1 byte) and transmit it as a block preceding the activation/deactivation string sent to a Master or Stand Alone scanner. Use characters from NUL (00H) to ~ (7EH). Click **Submit** to save your text to the origin window text field, or click **Cancel** to return to origin window without transferring text.

#### Terminator



**NOTE:** This parameter is available only when a communication channel has been selected to perform a specific function.

Click  to activate the **Text Entry Tool** and create a Terminator to define a terminator (1 byte) and transmit it as a block following the activation/deactivation string sent to the Master or Stand Alone scanner. Use characters from NUL (00H) to ~ (7EH). Click **Submit** to save your text to the origin window text field, or click **Cancel** to return to

origin window without transferring text.

### Activation String



**NOTE:** This parameter is available only when a communication channel has been selected to perform the **Activation** or **Activation and Deactivation** function.

Click  to activate the **Text Entry Tool** and create a string that defines the characters to be transmitted within the output message to activate the Energy Saving. Click **Submit** to save your text to the origin window text field, or click **Cancel** to return to origin window without transferring text.

### Deactivation String



**NOTE:** This parameter is available only when a communication channel has been selected to perform the **Deactivation** or **Activation and Deactivation** function.

Click  to activate the **Text Entry Tool** and create a character string to be transmitted within the output message to deactivate the Energy Saving. Click **Submit** to save your text to the origin window text field, or click **Cancel** to return to origin window without transferring text.

### User Socket n For

Select **None**, **Deactivation**, **Activation**, or **Activation and Deactivation** from the drop-down list. This parameter allows defining the function to be performed by a numbered **Socket**:

- **None:** No function is performed by the digital input.
- **Deactivation:** The digital input is used to deactivate the Energy Saving. Thus, the motor and laser of all network scanners will be turned on.
- **Activation:** The digital input is used to activate the Energy Saving. Thus, the motor and laser of all network scanners will be turned off.
- **Activation and Deactivation:** The digital input is used to both activate and deactivate the Energy Saving. Thus, the motor and laser of all network scanners will be turned on/off.

### Header



**NOTE:** This parameter is available only when a communication channel has been selected to perform a specific function.

Click  to activate the **Text Entry Tool** and create a **Header** (up to 128 bytes) to define a header (1 byte) and transmit it as a block preceding the activation/deactivation string sent to a Master or Stand Alone scanner. Use characters from NUL (00H) to ~ (7EH). Click **Submit** to save your text to the origin window text field, or click **Cancel** to return to origin window without transferring text.

### Terminator



**NOTE:** This parameter is available only when a communication channel has been selected to perform a specific function.

Click  to activate the **Text Entry Tool** and create a **Terminator** to define a terminator (1 byte) and transmit it as a block following the activation/deactivation string sent to the Master or Stand Alone scanner. Use characters from NUL (00H) to ~ (7EH). Click **Submit** to save your text to the origin window text field, or click **Cancel** to return to origin window without transferring text.

### Activation String



**NOTE:** This parameter is available only when a communication channel has been selected to perform the **Activation** or **Activation and Deactivation** function.



Click  to activate the **Text Entry Tool** and create a string that defines the characters to be transmitted within the output message to activate the Energy Saving. Click **Submit** to save your text to the origin window text field, or click **Cancel** to return to origin window without transferring text.

---

**Deactivation String**

**NOTE:** This parameter is available only when a communication channel has been selected to perform the **Deactivation** or **Activation and Deactivation** function.

Click  to activate the **Text Entry Tool** and create a character string to be transmitted within the output message to deactivate the Energy Saving. Click **Submit** to save your text to the origin window text field, or click **Cancel** to return to origin window without transferring text.

- 
3. When you have finished making changes, click **Update** to save or click **Reset** to revert to the previously saved values.

### 3.5.11 Modify Settings | Global Settings | HMI Settings (Human-Machine Interface)

Use the **HMI Settings** window to configure some aspects of the scanner LEDs and X-Press™ interface.

**To view and edit the HMI Settings:**

1. In the tree menu under **Modify Settings**, navigate to **Global Settings | HMI Settings**. The HMI Settings window opens.

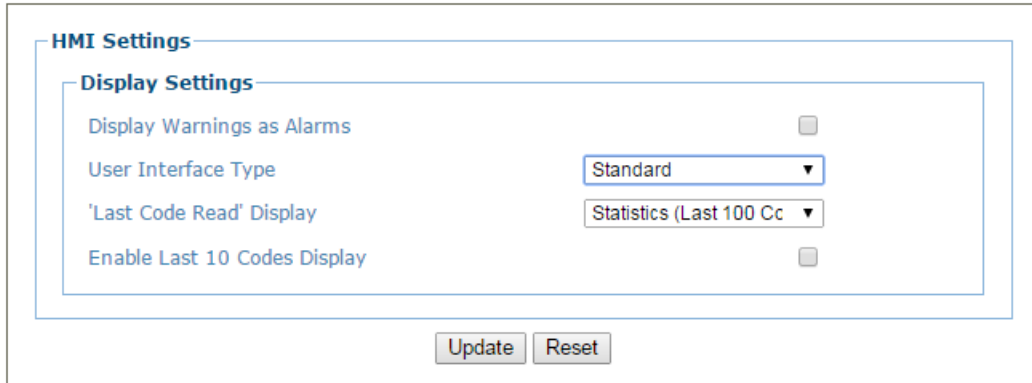

2. Enter the appropriate information in the form as described below:

Field Name	Action/Definition
<b>Display Settings</b>	
<b>Display Warnings as Alarms</b>	Select the check box enable function.
<b>User Interface Type</b>	Select <b>Standard</b> or <b>US Aiport</b> from the drop-down list.
<b>'Last Code Read' Display</b>	Select <b>Disable</b> , <b>Statistics (Last 100 Codes)</b> , or <b>Statistics</b> from the drop-down list.
<b>Enable Last 10 Codes Display</b>	Select the check box to display the last ten barcodes read.

3. When you have finished making changes, click **Update** to save or click **Reset** to revert to the previously saved values.

### 3.5.12 Redundant Operation

Use **Redundant Operation** to identify the active Master in a redundant system.

**To view and edit the Redundant Operation Settings:**

1. In the tree menu under **Modify Settings**, navigate to **Global Settings | Redundant Operation**. The **Redundant Operation** window opens.

**Redundancy Settings**

Redundancy Enable/Disable

Redundancy Topology Role Master Alone ▼

2. Enter the appropriate information in the form as described below:

Field Name	Action/Definition
<b>Redundancy Enable/Disable</b>	Select the check box to enable redundancy options.
<b>Redundancy Topology Role</b>	Select <b>Master Working</b> or <b>Master Protecting</b> from the drop-down list. A non-redundant system show Master Alone in this field, and it is not editable. <ul style="list-style-type: none"> <li>• <b>Master Working:</b> This is the system Master</li> <li>• <b>Master Protecting:</b> This is the system backup Master</li> </ul>

3. When you have finished making changes, click Update to save or click Reset to revert to the previously saved values.

### 3.6 DEVICE SETTINGS

Use the Device Settings Menu Tree selections during initial mounting and setup to view device information and configure your system devices. If multiple scanners are used in a tunnel or array, each named scanner will be listed under Device Settings with the sub-menus **Device Info**, **Mounting**, and **Options**. If necessary, you can later make modifications to the configuration using the same menu selections, including:

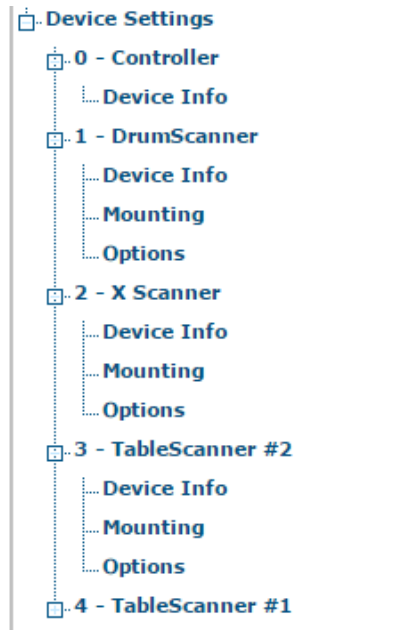

### 3.6.1 Device Settings | Device Name | Device Info

Use the **Device Info** window to information about each device in the system including description, serial number, and address.

To view the **Device Info** window:

1. In the tree menu under **Modify Settings**, navigate to **Device Settings | Device Name (if applicable) | Device Info**. The Device Info window opens.



**NOTE:** If more than one device is included in the scanning system, the device name will be listed in the menu tree after the Device Settings level.

**Device Information**

Description	Controller
Device Address	0
Serial Number	MSC 900X01
MAC Address	000E13040100
Model Name	MSC 900-1100
Model Number	101
Hardware Release	2
Number Legs	0
Number Lasers	0
Number Facets	0
Scan Rate (scans/sec)	1000 ▼

**Software Versions**

Software Version	ARM_release_v0_9_5_4
DSP Version	Decoder_release_v1_8_18_0
FPGA Version	XLC_v20_5_0_0

2. View the following scanner information:

Field Name	Definition
<b>Description</b>	Displays the scanner description entered in the System Info window.
<b>Device Address</b>	Displays the system address.
<b>Serial Number</b>	Displays the serial number sent by the device.
<b>MAC Address</b>	Displays the MAC (media access control) address of the device.
<b>Model Name</b>	Displays the Model name sent by the device.

---

<b>Model Number</b>	Displays the Model number sent by the device.
<b>Hardware Release</b>	Displays the hardware release number of the device.
<b>Number Legs</b>	Displays the number of laser legs (beams) produced by the device. Each BCL 900i (Line) scanner has 1 leg.
<b>Number Lasers</b>	Displays the number of lasers used by the scanner.
<b>Number Facets</b>	Displays the number of facets in the mirror wheel.
<b>Scan Rate (scans/sec)</b>	Displays the scans/per second achieved by the scanner.
<b>Software Versions</b>	
<b>Software Version</b>	Displays the currently installed version of the <b>ARM</b> (anonymizing relay monitor) software.
<b>DSP Version</b>	Displays the currently installed version of the decoder software.
<b>FPGA Version</b>	Displays the currently installed version of the <b>field-programmable gate array</b> software.

---

### 3.6.2 Device Settings | Device Name | Mounting

Use the **Mounting** window to configure some aspects of the scanner LEDs and X-Press™ interface.

To view and edit the **Mounting** settings:

1. In the tree menu under **Modify Settings**, navigate to **Device Settings | Device Name (if applicable) | Mounting**. The **Mounting** window opens.



**NOTE:** If more than one device is included in the scanning system, the device name will be listed in the menu tree after the **Device Settings** level.

PackTrack Calibration Coefficients	
Y Adjustment	0 mm
Calibration Item 1	0.738934
Calibration Item 2	0.093086
Calibration Item 3	443.324799
Calibration Item 4	-0.736568
Calibration Item 5	0.152025
Calibration Item 6	1157.441406
Calibration Item 7	-0.032004
Calibration Item 8	-0.997090
Calibration Item 9	1519.108276

2. Enter the appropriate information in the form as described below:

Field Name	Definition
<b>Calibration Method</b>	Select <b>Specify Mounting</b> or <b>PackTrack Calibration</b> from the drop-down list. If <b>Specify Mounting</b> is selected, you must manually enter the requested data. If <b>PackTrack Calibration</b> is selected, use the wizard to automatically enter most of the data.
<b>PackTrack Calibration</b>	
<b>PackTrack Calibration Wizard</b>	Click <b>Launch Wizard</b> to open the <b>PackTrack™ Calibration Wizard</b> . For complete instructions on setting up your scanners using <b>PackTrack</b> , see the <i>BCL 900i Reference Manual</i> , available at <a href="http://www.leuze.de">www.leuze.de</a> .

<b>Calibration Adjustment</b>	<b>Y Adjustment</b>	Enter the scanner adjustment from <b>Y</b> axis in millimeters in the field provided. This is used to make fine adjustments to the tested calibration.  For complete instructions on setting up your scanners using <b>PackTrack</b> , see <i>the BCL 900i Reference Manual</i> , available at <a href="http://www.leuze.de">www.leuze.de</a> .
<b>PackTrack Calibration Coefficients</b>	<b>Calibration Item 1-9</b>	These non-editable fields display the PackTrack calculations.

- When you have finished making changes, click **Update** to save or click **Reset** to revert to the previously saved values.

### PackTrack™ Calibration Wizard

**PackTrack™** is a patented operating mode for **Omni-Directional Reading Stations** used to read and correctly assign codes read on different packs when placed in the scanner Reading Area at the same time.

For complete instructions on setting up your scanners using **PackTrack**, see *the BCL 900i Reference Manual*, available at [www.leuze.de](http://www.leuze.de).



### 3.6.3 Device Settings | Device Name | Options

Use the **Options** window to configure some aspects of the scanner LEDs and X-Press™ interface.

To view and edit the **Options** settings:

1. In the tree menu under **Modify Settings**, navigate to **Device Settings | Device Name (if applicable) | Options**. The Options window opens.



**NOTE:** If more than one device is included in the scanning system, the device name will be listed in the menu tree after the Device Settings level.



**NOTE:** Options will vary depending on which device is being represented.

The screenshot shows a configuration window titled "Scanner Options". It contains the following settings:

- Field of View Start Angle: 45 degrees
- Field of View Stop Angle: 45 degrees
- Barcode Reconstruction:
- Enable Stacked Codes:

Below these is a sub-section titled "Advanced Reading Settings" containing:

- Overflow Start Ratio: 5
- Overflow Stop Ratio: 5

At the bottom of the window are two buttons: "Update" and "Reset".

2. Enter the appropriate information in the form as described below:

Field Name	Definition
------------	------------

<b>Field of View Start Angle</b>	Enter the field of view (FOV) start angle in the field provided. This will adjust the start FOV angle to that specified.
----------------------------------	--

In the example below, the original **Start Angle** of 30° is reduced to 25° degrees when that value is entered.

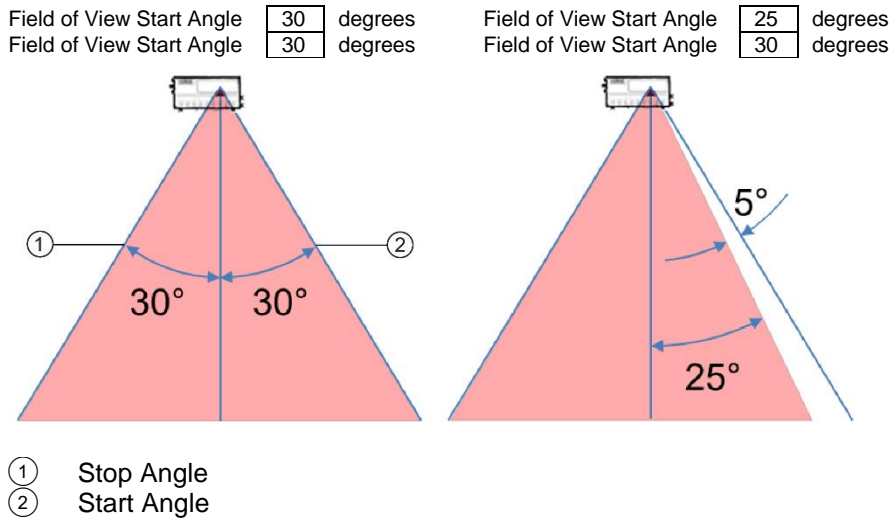

**Figure 15: Start/Stop Angle**



**NOTE:** This option is only available for the BCL 900i scanner.

<b>Field of View Stop Angle</b>	Enter the field of view (FOV) stop angle in the field provided. This will adjust the start FOV angle to that specified.
---------------------------------	---



**NOTE:** This option is only available for the BCL 900i scanner.

<b>Barcode Reconstruction</b>	Select the check box to enable Code Reconstruction (CRT) when reading the code. If not checked, standard linear reading mode will be used.
-------------------------------	--

**Advanced Reading Settings**

<b>Overflow Start Ratio</b>	Enter the minimum expected width of the barcode starting quiet zone, expressed in number of modules from 1 to 50.
-----------------------------	---

<b>Overflow Stop Ratio</b>	Enter the minimum expected width of the barcode stopping quiet zone, expressed in number of modules from 1 to 50.
----------------------------	---

3. When you have finished making changes, click **Update** to save or click **Reset** to revert to the previously saved values.

### 3.7 DIAGNOSTICS

Use the **Diagnostics** menu tree selections to monitor your barcode scanning system performance, view system messages, and access online help. The **Diagnostic** windows include:

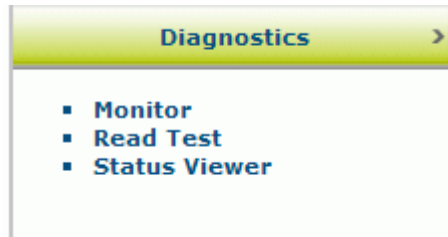

### 3.7.1 Diagnostics | Monitor

Use the Diagnostics > Monitor as the primary tool to monitor the reader's operation and bar code readability in real-time. Status indicators and vital statistics appear on a single screen, enabling you to effectively and efficiently detect and troubleshoot any problems that may occur



**NOTE:** The Monitor is a Java application and requires Java and the appropriate browser plug-in.

**To open the Monitor window:**

In the tree menu under **Diagnostics**, navigate to **Monitor**. The **Monitor** window opens.

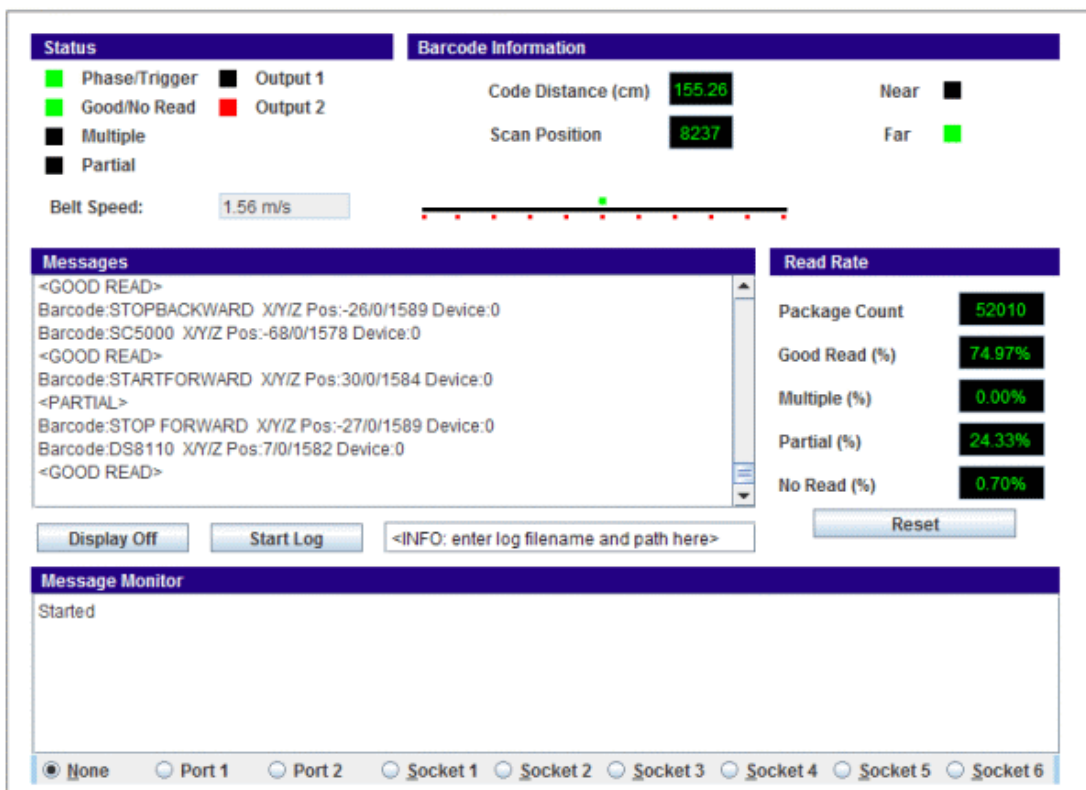

The status indicators in **Diagnostics > Monitor** indicate the following conditions:

Field	Definition
<b>Status</b>	
<b>Phase/Trigger</b>	<b>GREEN</b> indicates trigger input. The LED is activated upon trigger input regardless of trigger source (including software trigger).
<b>Good/No Read</b>	<b>GREEN</b> indicates a good (valid) bar code has been decoded. <b>RED</b> indicates a no-read (or incomplete decode).
<b>Multiple</b>	<b>RED</b> indicates more codes than desired were read.

**Partial**            **RED** indicates a partial read.

**Output 1 /  
Output 2**            **RED** indicates activity on that output.

**Belt Speed**            Indicates the current speed of the belt indicated by the encoder (tachometer).

#### Barcode Information

**Code  
Distance (cm)**            Displays the distance from the laser origin to the scanned barcode.

**Scan Position**            Displays the position of the code in the scan line.

**Near**                    **GREEN** indicates the barcode has been scanned by the near-focus laser.

**Far**                      **GREEN** indicates the barcode has been scanned by the far-focus laser.

#### Messages

**Message  
Field**                    Displays message data being returned by the scanner for each barcode scanned.

**Display  
Off/On**                    Click to toggle the real-time messages off or on.

**Start Log**                    Click to create a log file from the time of the click. Enter a filename and path for the log file in the field provided.

#### Read Rate

**Package  
Count**                    Displays the number of packages detected since the last reset.

**Good Read  
(%)**                      Displays the number of good barcode reads since the last reset.

**Multiple (%)**            Displays the number of multiple barcodes detected since the last reset.

**Partial (%)**              Displays the number of partially read barcodes since the last reset.

**No Read (%)**            Displays the number of no reads (no barcode read on package) since the last reset.

**Reset**                      Click to reset the above counters.

#### Message Monitor

**Message  
Monitor Field**            Select the option button beside **Port 1, Port 2, Socket 1, Socket 2, Socket 3, Socket 4, Socket 5, or Socket 6** to display messages for that host port.

Select the option button beside **None** to stop displaying messages.

### 3.7.2 Diagnostics | Read Test

Use the Read Test window to check how well a scanner is operating.

**To test a scanner's operation:**

1. In the tree menu under **Diagnostics**, navigate to **Read Test**. The **Read Test** window opens.

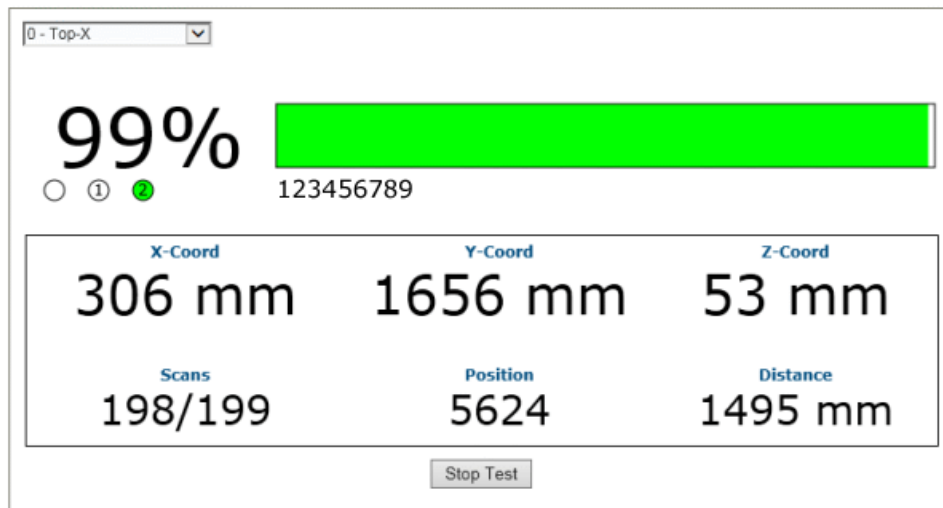

2. If there are multiple scanners in the system, select the scanner to test from the drop-down list at the top of the **Read Test** window.
3. Click the **Start/Stop Test** toggle button to run or stop the real-time performance display of the scanner.

**The Read Test displays the following information:**

- **Read Rate:** This is the percentage readout and bar at the top of the window, displaying the read rate since the start of the test.

The numbered circle indicators below the read-rate percentage indicate in **GREEN**, which of the scanner's lasers is reading the barcode.

The alpha numeric text following the numbered circle indicators is the barcode data.

- **Laser Identifiers:** These circles below the Read Rate percentage identify the number of lasers in the scan head as well as highlighting in GREEN the laser that is reading the barcode. In the example above, the scanner has two lasers and laser 2 is identified as reading the code. If the first circle is highlighted in RED, this indicates a NOREAD.
- **XYZ Coord:** This displays the real-time coordinates of the barcodes being read.
- **Scans:** Displays the number of times the scanner decoded the test barcode out of the number of opportunities it had to decode the test barcode during a test cycle.
- **Position:** Displays the position of the barcode in the scan line.
- **Distance:** Displays the distance from the laser origin to the last barcode read.

### 3.7.3 Diagnostics | Status Viewer

Use the **Status Viewer** to check up on your scanner health.

#### To access and use the Status Viewer:

1. In the tree menu under Diagnostics, navigate to Status Viewer. The Status Viewer window opens.

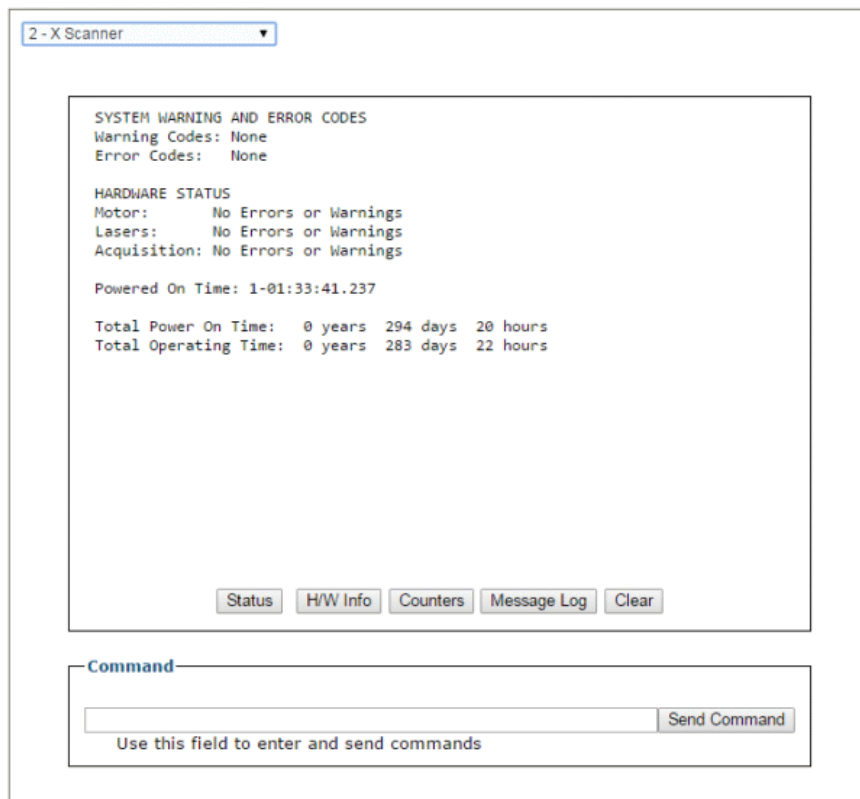

2. Select a device to view from the drop-down list at the top-left corner of the window.
3. Click on a button at the bottom of the display window to select the type of information you want to view:
  - **Status:** displays system warnings or errors.

```
SYSTEM WARNING AND ERROR CODES
Warning Codes: None
Error Codes: None

HARDWARE STATUS
Motor: No Errors or Warnings
Lasers: No Errors or Warnings
Acquisition: No Errors or Warnings

Powered On Time: 1-01:33:41.237

Total Power On Time: 0 years 294 days 20 hours
Total Operating Time: 0 years 283 days 22 hours
```

- **Read Rate:** displays read rate and package count information.

```

READ RATE
Total Packages:      34204
Good Reads:         25086    73%
No Reads:           837      2%
Partial:            8281    24%
Multiple:            0        0%
    
```

- **H/W Info:** displays information about the selected hardware, including model, serial number, scans/second, laser information, and more.

```

CONFIGURATION
Model Type:  BCL900iSM 102
Serial Num:  C14C03507
Mac Address: 00-07-be-00-ef-8a
Num Lasers:  2
Num Legs:    1
Num Facets:  7

CURRENT STATUS
Scan Rate:    1000 scans/sec
Current APD DAC: 469

          Temp      VCC
Laser 1:    40.59 C  3.2790
Laser 2:    40.89 C  3.2722
Logic Board: 39.00 C
APD Board:  41.50 C
    
```

- **Counters:** displays cumulative data about scans, triggers, errors, and much more.

```

SYSTEM INFO
Scan Rate (scans/sec): 999      Belt Speed (m/s): 1.55
Tach Rate (cnts/sec) : 2429    Belt Speed (ft/min): 306

DECODER COUNTERS
Scan Ints:      14796    DSP Codes:      59214
Triggers:      59548    DSP Triggers:   960
Process L0:    25824    Process L1:     0
Max Elements L0: 310    Max Elements L1: 0
Queue Size:    1        Queue Max:      9
Mem Alloc Err: 0        Memory Full:    0

SCAN DATA EXCEPTION COUNTERS
Missed DMA:    0        Missed QDMA:    0
Xfer Overflow: 0        Xfer Bad Length: 0
ASTRA Seg Err: 0        Invalid Leg No: 0
Low Term Count: 0      High Term Count: 0
Motor Var Cnt: 0

ARM Restarts:  0        DSP Restarts:   0
    
```



- **Message Log:** displays messages logged since the last clear command.

```
0-00:00:00.723: APD Read: DAC/Temp Ref: 243/6400
0-00:00:00.723: APD Read: Gain/Offset/Min/Max/Type: -1/-1/-1/-1/-1
0-00:00:00.725: APD DAC Initialized.
0-00:00:00.852: ADC Configuration Complete.
0-00:00:00.959: Loading FPGA file XLC_v20_0_0_0.fpga.
0-00:00:03.938: FPGA device id: 4c55.
0-00:00:03.938: FPGA version: 6.0(0).
0-00:00:06.378: Loading DSP file Decoder_release_v1_8_17_0.dsp.
0-00:00:06.678: DSP load complete.
0-00:00:06.678: Scan Engine Started.
0-00:00:06.679: FPGA Buffer Export Task Started
0-00:00:14.664: Motor Speed Threshold set to 0xFFFF.
0-00:00:14.664: FIR Filter Coefficients Loaded.
0-00:00:14.664: Scan FOV set to 88 deg (off=1562 len=21420)
0-00:00:15.263: Ethernet Initialization Complete.
0-00:00:15.263: Web Server Initialization Complete.
0-00:00:16.665: DSP Version 1.8.17 Started.
0-00:00:16.665: Scan Engine Initialized.
0-00:00:16.686: IsAlone=0 IsMaster=0 NumDevices=3
Powered On Time: 0-00:38:22.825
```

4. Click **Clear** to clear out the **Message Log**.

You can also enter a specific system command in the field provided at the bottom of the window. Click **Send Command** to execute.

### 3.8 UTILITIES

Use the Utilities menu tree selections to backup, restore, and update system firmware, or to reboot the scanner. The **Utilities** windows include:



#### 3.8.1 Utilities | Backup or Restore

Use **Backup or Restore** to save all the settings to the dimensioner and backup the settings to the backup module and/or file.

**To use the Backup or Restore functions:**

1. In the tree menu under **Utilities**, click **Backup or Restore** Info. The Backup or Restore window opens.

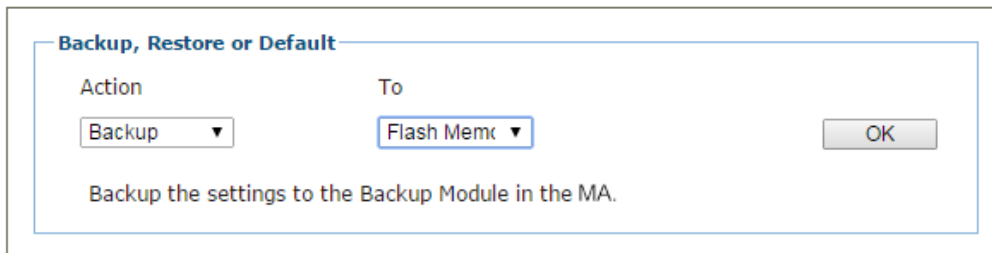

2. From the drop-down lists shown, select an **Action** and a **To/From** option.

Action	To/From	
<b>Backup</b>	<b>Flash Memory</b>	When this option is selected, click <b>OK</b> to save the settings to the Backup Module (BM100) in the MA Connection Box. A progress box displays the percent complete of the save operation.

  

Utilities | Backup or Restore

**File** When this option is selected, click **OK** to download the file to your computer. The file can then be saved to an appropriate backup folder.

**Restore Flash Memory** When this option is selected, click **OK** to retrieve the settings to the Backup Module in the MA. A progress box displays the percent complete of the restore operation.

**File** When this option is selected, a **Choose File** button is revealed. Click **Choose File** to open a file browser and located the settings .txt file to be restored. When the file has been located and selected, click **OK** to save the file to the device.

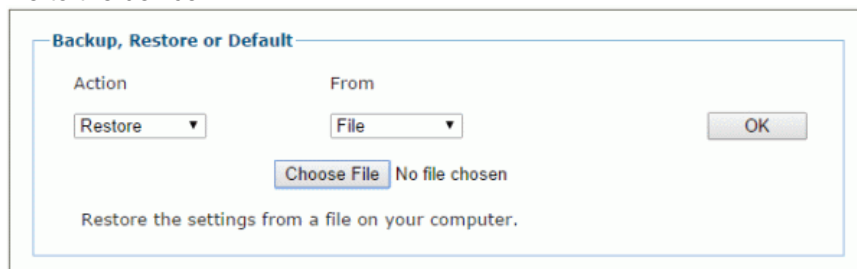

Backup, Restore or Default

Action: Restore      From: File      OK

Choose File      No file chosen

Restore the settings from a file on your computer.

**Default Application** When this option is selected, click **OK** to restore application settings to Factory defaults, except for Ethernet and PackTrack.

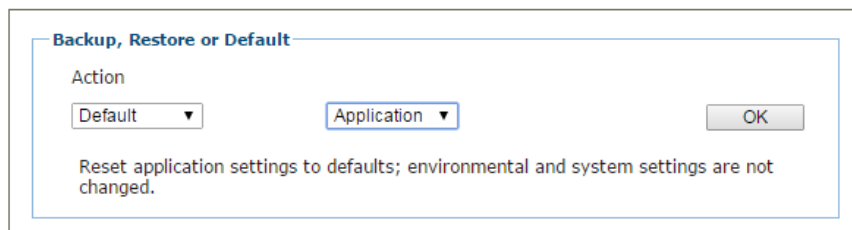

Backup, Restore or Default

Action: Default      Application      OK

Reset application settings to defaults; environmental and system settings are not changed.

**App and Env** When this option is selected, click **OK** to restore all settings including Ethernet and Packtrack.

**All** When this option is selected, click **OK** to **COMPLETELY RESET** the scanner to Factory configuration.

### 3.8.2 Utilities | Reboot

Use the **Reboot** window to restart the scanner or system.

**To use the Reboot function:**

1. In the tree menu under **Utilities**, click **Reboot** Info. The Reboot window opens.

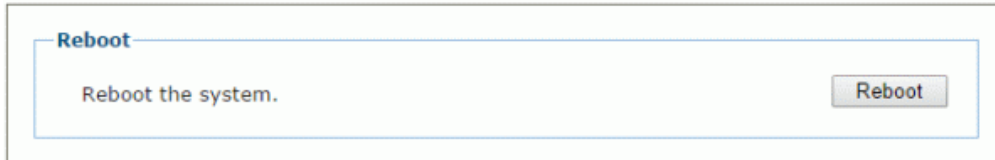

2. Click **Reboot**. A confirmation box appears.

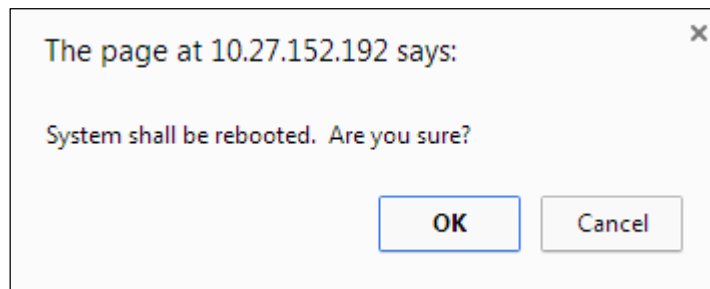

3. Click **OK** to reboot the system, or click **Cancel** to return to the reboot window without restarting the system.

### 3.8.3 Utilities | Update Firmware

Use **Update Firmware** to reload the scanner system firmware.



**CAUTION:** This function should only be performed under the guidance of Leuze electronic Technical Support.

#### To Extract Image:

1. In the tree menu under **Utilities**, click **Update Firmware**. The Update Firmware window opens.

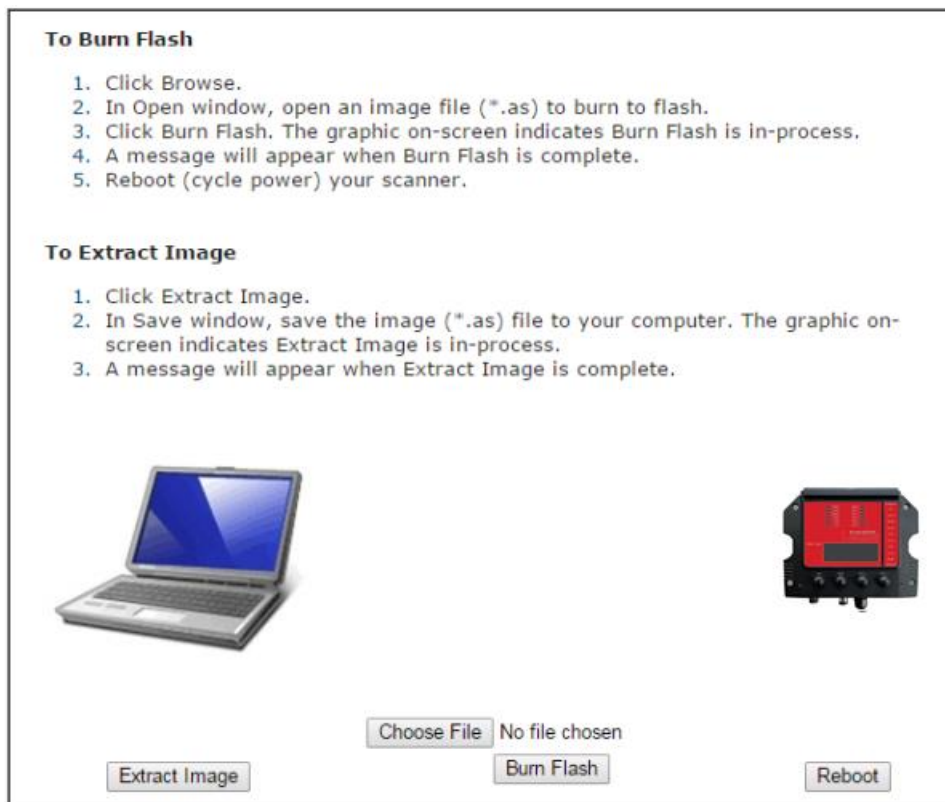

2. Click **Extract Image**. A confirmation box appears.

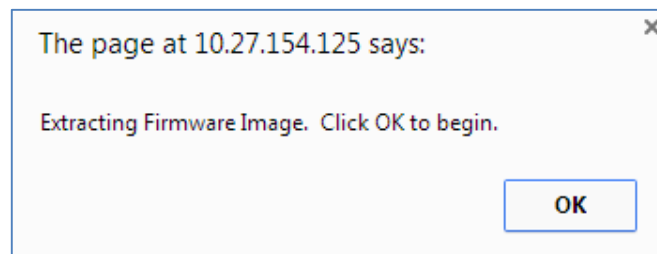

3. Click **OK** to continue.

4. The graphic on screen indicates **Extract Image** is in-process. A message will appear when **Extract Image** is complete.

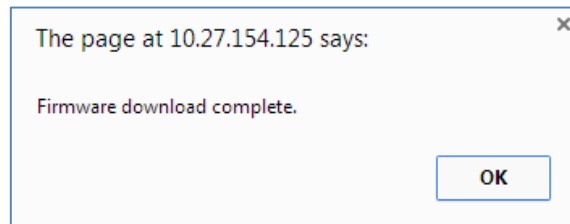

#### To Burn Flash:

1. Click **Choose File**. In the browse window, select an image file (\*.as) to burn to flash.



**NOTE:** The appearance of these functions may vary from browser to browser.

2. Click **Burn Flash**. The graphic on-screen indicates **Burn Flash** is in-process.
3. A message will appear when **Burn Flash** is complete.

#### To Reboot the System:

1. Click **Reboot**. A confirmation box appears.

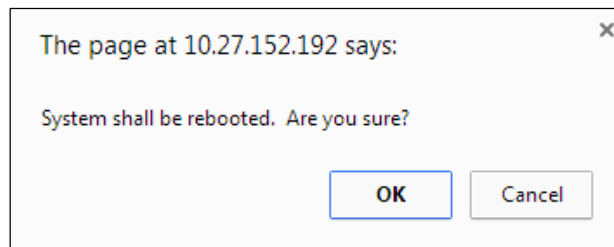

2. Click **OK** to reboot the system, or click **Cancel** to return to the reboot window without restarting the system.

### 3.8.4 Utilities | Help

The complete help for the **MSC 900 User Interface** is available in this manual.

**To access the complete help system:**

Select **Utilities | Help** in the User Interface menu tree.

## 4 MAINTENANCE

---

### 4.1 BACKUP AND AUTOMATIC REPLACEMENT PROCEDURE

Once the system configuration has been completed using the User Interface as described in *section 3*, perform backup by one of the following methods:

#### 4.1.1 Backing Up the System Using the MSC 900 Keypad

1. Press the **ENT** and **MENU** keys simultaneously to enter the Menu.
2. Use the **UP** and **DOWN** keys to move within the menu items.
3. In the **<System>** menu select **<Backup>**.
4. From the **<Backup>** menu, press the **ENT** key to back up the system, or press the **CLR** key to back out of the menu.

The MSC 900 Controller will store the complete system configuration on the Compact Flash card.

If a slave scanner has to be replaced, the corresponding configuration (node address, code configuration, PackTrack™ configuration, etc.) is automatically downloaded by the MSC 900 into the new scanner at the next system startup.

In case of MSC 900 failure, the complete system configuration can be recovered from the Compact Flash of the damaged MSC 900: by simply installing the old Compact Flash in the new MSC 900, the system configuration is automatically restored and the reading station is ready to start working again.



**CAUTION:** Before removing the Compact Flash card, disconnect power from the MSC 900 Controller.

#### 4.1.2 Backing Up the System Using the User Interface

You can also back up the system through the User Interface. See *section 3.8.1 Backup or Restore*.



### 4.1.3 Replacing an MSC 900

In case of MSC 900 failure, proceed as follows:

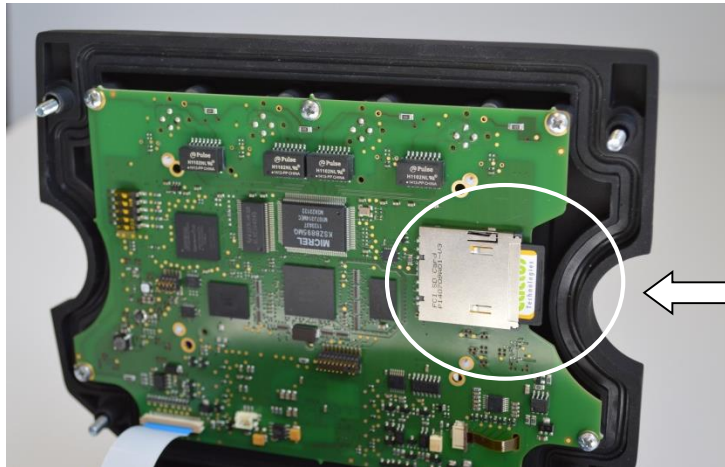

Figure 16 – Removing the Compact Flash

1. Disconnect power from the device.
2. Loosen the screws in the MSC 900 lid using a screwdriver.
3. Remove the Compact Flash.
4. Connect a new MSC 900 to the system.
5. Insert the Compact Flash card.
6. Close and secure the lid of the replacement MSC 900.



**CAUTION:** Make sure not to insert the Compact Flash card upside down. Carefully insert it in the guides, so that it will not fall inside the device. Gently push it into the slot.

7. Power up the system.

The system configuration is automatically restored and the reading station is ready to start working again.

## 5 TROUBLESHOOTING

---



**IMPORTANT:** Due to the complex and application-specific nature of these installations, operational deficiencies of the barcode scanner must be diagnosed and serviced by a trained and authorized Leuze electronic technician.

There are no user serviceable components or field replaceable units (FRUs) inside the barcode scanner.

For further information on training, contact us through the Leuze electronic website at [www.leuze.de](http://www.leuze.de).



**NOTE:** When contacting Leuze electronic for help with a scanner, please be ready to share the unit serial number with the Leuze electronic technician. The unit's serial number tag is located on the device, where shown below. Help desk contact information is available at [www.leuze.de](http://www.leuze.de)

## 5.1 ERROR CODES AND RESOLUTIONS

Error Code	Description	Severity	Explanation	Symptom	Troubleshooting	Action required
1	Node not responding	Error	In a Master/Slave configuration, the Master monitors the status of the Slaves in its network. If a slave unit fails to be identified, the Master will post this message.	<ul style="list-style-type: none"> <li>The scanning tunnel's no-read rate increases.</li> <li>More than one slave unit may be shown as not responding.</li> </ul>	<ul style="list-style-type: none"> <li>In a tunnel configuration, the cabling that connects the system into to a network must be intact or a scanner will be reported as not responding.</li> <li>Make sure all the slave units are powered on.</li> </ul>	<ul style="list-style-type: none"> <li>Make sure cables are connected.</li> <li>Check scanners power source.</li> <li>Replace scanner.</li> </ul>
80	Node Reset	Error	In a Master/Slave configuration, the Master monitors the status of the Slaves in its network. If a Slave resets, it sends a reset message to the Master. The Master then posts this error condition on the diagnostic screen.	<ul style="list-style-type: none"> <li>The scanning tunnel's no-read rate may increase during the Slave scanner's reconnection.</li> </ul>	<ul style="list-style-type: none"> <li>This condition is related to a slave scanner. Make sure the power source of the slave is not faulty.</li> </ul>	<ul style="list-style-type: none"> <li>If condition persists, replace the scanner.</li> </ul>
81	Motor Failure	Error	The scanner's mirror wheel motor has failed.	<ul style="list-style-type: none"> <li>The scanner will be powered up but will not emit laser light from its exit window.</li> <li>The scanners motor will not be spinning.</li> </ul>	<ul style="list-style-type: none"> <li>Hold your hand in front of the scanner to determine if the laser is on.</li> </ul>	<p>This is an internal failure and is not field serviceable</p> <ul style="list-style-type: none"> <li>Replace scanner.</li> </ul>
83	Laser Failure	Error	Scanner has a laser failure.	<ul style="list-style-type: none"> <li>There is no laser light emitted from the scanner</li> <li>The mirror wheel motor may still be spinning, however, the motor speed may be out of range at which time the scanner will turn off the laser light.</li> </ul>	<ul style="list-style-type: none"> <li>Hold your hand in front of the scanner to determine if the laser is on.</li> </ul>	<p>This is an internal failure and is not field serviceable.</p> <ul style="list-style-type: none"> <li>Replace scanner.</li> </ul>

Error Code	Description	Severity	Explanation	Symptom	Troubleshooting	Action required
130	Encoder Timeout	Warning	<p>No encoder (tachometer) is detected in specified time. The Encoder signal provides the scanner with belt speed and other tracking information.</p> <p>This error will only occur when the scanner is in the PackTrack mode.</p>	<ul style="list-style-type: none"> <li>The scanner may experience an increase in no-reads.</li> <li>The scanner may start missing the transmit point.</li> </ul>	<ul style="list-style-type: none"> <li>Confirm that the belt is running.</li> <li>Make sure the encoder (tachometer) wheel is making a firm contact with the conveyor.</li> <li>Check the <b>Global Settings   Diagnostics   Encoder Timeout</b> setting to confirm that it is not set too low (See section 3.5.9).</li> </ul>	<ul style="list-style-type: none"> <li>Adjust the encoder (tachometer) mounting.</li> <li>Adjust the <b>Encoder Timeout</b> setting (See section 3.5.9).</li> </ul>
131	Input 1 Failure	Error	<p>The Primary PS (photoelectric sensor) Input is stuck in the active state (PackTrack Mode).</p>	<ul style="list-style-type: none"> <li>The scanner will not go into trigger.</li> <li>No data will be transmitted to the Host.</li> </ul>	<ul style="list-style-type: none"> <li>Check the alignment of the photoelectric sensor.</li> <li>Check the functionality of the photoelectric sensor.</li> </ul>	<ul style="list-style-type: none"> <li>Realign the photoelectric sensor.</li> <li>Replace the photoelectric sensor.</li> </ul>
132	No Phase Error	Error	<p>No Phase "timeout" is exceeded (On-Line and PackTrack Mode).</p> <ul style="list-style-type: none"> <li>Trigger must be identified within a specified time.</li> </ul>			
133	Input 2 Failure	Error	<p>Secondary PS (photoelectric sensor) Input Failure Stuck Active (PackTrack Mode).</p>	<ul style="list-style-type: none"> <li>The scanner will not go into trigger.</li> <li>No data will be transmitted to the Host.</li> </ul>	<ul style="list-style-type: none"> <li>Check the alignment of the photoelectric sensor.</li> <li>Check the functionality of the photoelectric sensor.</li> </ul>	<ul style="list-style-type: none"> <li>Realign the photoelectric sensor.</li> <li>- Replace the photoelectric sensor.</li> </ul>

Error Code	Description	Severity	Explanation	Symptom	Troubleshooting	Action required
135	Encoder Failure	Error	Phase input (trigger source) is activated while encoder (tachometer) is stopped (PackTrack Mode).	<ul style="list-style-type: none"> <li>No data will be transmitted to the host.</li> <li>Scanner(s) will not read any barcodes.</li> <li>System receives trigger cycle when no encoder signal is present.</li> </ul>	<ul style="list-style-type: none"> <li>Check <b>Diagnostics   Monitor</b> to see if the scanner is reporting a conveyor speed (<i>See section 3.7.1</i>).</li> <li>Make sure the encoder (tachometer) wheel is making a firm contact with the conveyor.</li> </ul>	<ul style="list-style-type: none"> <li>Adjust, realign, or replace the encoder (tachometer).</li> </ul>
157	SD Card Failure	Error	MSC 900-SD card cannot be accessed. The SD card contains the backup files. It also contains a copy of the scanners application software.  This failure is only in the MSC 900.	<ul style="list-style-type: none"> <li>Unit will not backup or restore the parameters.</li> </ul>	<ul style="list-style-type: none"> <li>Try to save the parameters from the <b>MSC 900</b> to the SD card (<i>see MSC 900 System Controller Reference Manual</i>).</li> </ul>	<ul style="list-style-type: none"> <li>Confirm that the SD card is seated properly in the MSC 900.</li> <li>Replace SD card (<i>see MSC 900 System Controller Reference Manual</i>).</li> </ul>
169	Main Serial Port Error	Error	Protocol Index message not received on Main Serial Port.			
176	Aux Serial Port Error	Error	Protocol Index message not received on Aux Serial Port.			
178	Ethernet Socket 1 Error	Error	Protocol Index message not received on User Socket 1.			
179	Ethernet Socket 2 Error	Error	Protocol Index message not received on User Socket 2.			
180	Ethernet Socket 3 Error	Error	Protocol Index message not received on User Socket 3.			
181	Ethernet Socket 4 Error	Error	Protocol Index message not received on User Socket 4.			

Error Code	Description	Severity	Explanation	Symptom	Troubleshooting	Action required
182	Ethernet Socket 5 Error	Error	Protocol Index message not received on User Socket 5.			
183	Ethernet Socket 6 Error	Error	Protocol Index message not received on User Socket 6.			
191	Fieldbus Mismatch	Error	Fieldbus module type does not match specified model.  <ul style="list-style-type: none"> <li>Module selection incorrect compared to the actual module installed.</li> </ul>			
193	Fieldbus Config Error	Error	Error configuring fieldbus module.	<ul style="list-style-type: none"> <li>Unable to communicate to the module.</li> </ul>	<ul style="list-style-type: none"> <li>Confirm that the unit is not communicating to the host.</li> <li>- Confirm that the fieldbus parameters are configured properly (<i>see section 3.5.6</i>).</li> </ul>	<ul style="list-style-type: none"> <li>Replace fieldbus module.</li> </ul>
195	Fieldbus DHCP Error	Error	Profinet module had a DHCP error.	<ul style="list-style-type: none"> <li>Unable to acquire an IP address.</li> </ul>	<ul style="list-style-type: none"> <li>Confirm that the unit is not communicating to the host.</li> <li>Confirm that the fieldbus parameters are configured properly (<i>see section 3.5.6</i>).</li> </ul>	<ul style="list-style-type: none"> <li>Replace fieldbus module.</li> </ul>
205	APD Temperature Error	Error	APD Temperature sensor is not working. A fluctuation in the scanner's temperature can have an adverse effect on several internal functions of the scanner. The scanner monitors the temperature, and if it is erratic, this error is posted.	<ul style="list-style-type: none"> <li>The scanner may experience an increase in no-reads.</li> <li>The scanner may start missing the transmit point.</li> </ul>	<ol style="list-style-type: none"> <li>Cycle power on the scanner;</li> <li>Wait until the unit has time to cool down.</li> <li>Restart the scanner and monitor it to determine whether the error reoccurs.</li> </ol>	<p>This is an internal failure and is not field serviceable.</p> <ul style="list-style-type: none"> <li>Replace scanner.</li> </ul>

Error Code	Description	Severity	Explanation	Symptom	Troubleshooting	Action required
207	In Beam Sensor Error	Error	The scanner has an in-the-beam sensor, which provides timing for the decoding of barcodes. The scanner monitors this signal, and posts this error if the signal is sporadic or missing.	<ul style="list-style-type: none"> <li>The scanner stops reading barcodes.</li> </ul>	<ul style="list-style-type: none"> <li>Put the scanner in the test mode to test its ability to read the barcode (<i>see section 3.7.2</i>).</li> </ul>	<p>This is an internal failure and is not field serviceable.</p> <ul style="list-style-type: none"> <li>Replace scanner.</li> </ul>
211	PTP Error	Error	Cannot synchronize the internal clock using the PTP (precision time protocol) protocol. This clock sync pulse is generated by the controller unit. It is used to sync the read data of all the scanners in the network with the master unit.	LEDs flashing.	<ul style="list-style-type: none"> <li>Confirm that all the scanners are connected in the chain.</li> <li>Use the scanner test mode to confirm that the scanner can statically reading a barcode (<i>see section 3.7.2</i>).</li> <li>Position a barcode on a box so it faces the questionable scanner, and dynamically test the scanner.</li> </ul>	<ul style="list-style-type: none"> <li>- Replace faulty scanner.</li> </ul>
219	Fieldbus Comm Error	Error	Cannot communicate with the fieldbus module.	<ul style="list-style-type: none"> <li>The host loses communication with the scanner.</li> </ul>	<ul style="list-style-type: none"> <li>Confirm that the unit is not communicating with the Host.</li> <li>Confirm that the fieldbus parameters are configured properly (<i>see section 3.5.6</i>).</li> </ul>	<ul style="list-style-type: none"> <li>- Replace fieldbus module.</li> </ul>

Error Code	Description	Severity	Explanation	Symptom	Troubleshooting	Action required
220	Network Ring Open	Error	When the MSC 900 is used, the scanner internal network is connected in a chain configuration. If the MSC 900 detects that network chain is not complete, it will post this error.	<ul style="list-style-type: none"> <li>The system experiences a higher no-read rate.</li> <li>One or more scanners may not appear on the System Info page (see section 3.4).</li> </ul>	<ul style="list-style-type: none"> <li>Confirm that all the scanners are connected in the chain.</li> <li>Use the scanner test mode to confirm that the scanner can statically reading a barcode (see section 3.7.2).</li> <li>Position a barcode on a box so it faces the questionable scanner, and dynamically test the scanner.</li> </ul>	<ul style="list-style-type: none"> <li>- Replace faulty scanner.</li> </ul>

## 5.2 TROUBLESHOOTING GUIDE

TROUBLESHOOTING GUIDE	
Problem	Suggestion
<b>Power On:</b> The <b>POWER</b> LED is not lit.	<ul style="list-style-type: none"> <li>Is power connected?</li> </ul>
<b>Power On:</b> The <b>POWER</b> LED is RED.	<ul style="list-style-type: none"> <li>The power supply polarity is reversed: fix it.</li> </ul>
<b>On Line Mode 1:</b> The <b>TRIG</b> LED is not lit (when external trigger activates).	<ul style="list-style-type: none"> <li>Depending on the installation:               <ul style="list-style-type: none"> <li>Is the PNP sensor connected to the MSC 900's TRIG M12 input connector?</li> <li>Is the sensor correctly wired in the MA 900 connection box?</li> <li>Is power supplied to photo sensor?</li> </ul> </li> </ul>
<b>On Line Mode 1:</b> The <b>TRIG</b> LED is correctly lit but nothing happens (no reading results).	<ul style="list-style-type: none"> <li>Is the software configuration consistent with the application condition (operating mode, etc.)?</li> </ul> <p>In the User Interface, select the OPERATING MODES folder and check for related parameters.</p>



<b>TROUBLESHOOTING GUIDE</b>	
<b>Problem</b>	<b>Suggestion</b>
<p><b>Serial On Line Mode:</b> The reader is not triggered (no reading results).</p>	<ul style="list-style-type: none"> <li>• In the User Interface select the OPERATING MODE folder and check if serial on line is enabled as “On Line options” parameter value.</li> <li>• Are the Start-Stop strings correctly assigned?</li> <li>• Is the serial trigger source correctly connected and configured)?</li> </ul>

<p><b>Communication (Main / Aux):</b> the device is not transmitting anything to the host.</p>	<ul style="list-style-type: none"> <li>• Is serial Main / Aux cable connected?</li> <li>• Is wiring correct?</li> <li>• If using the Main RS232 or RS422 interface, is the reference ground connected to SGND MAIN? Be careful that it is not completely different from GND power ground.</li> <li>• Are serial host settings equivalent to serial device setting?</li> </ul>
<p><b>On Line Mode and Serial On Line Mode:</b> The reader does not respond correctly to the expected external signal end.</p>	<ul style="list-style-type: none"> <li>• In the User Interface, select the OPERATING MODES folder and check the “Reading Phase Timeout” parameterization.</li> </ul>
<p><b>Communication (Ethernet):</b> the Ethernet LED is not lit.</p>	<ul style="list-style-type: none"> <li>• Verify the HUB connection.</li> <li>• Verify User Interface settings (<i>see section 3.5.5</i>).</li> </ul>
<p><b>Communication:</b> data do not appear on the terminal.</p>	<ul style="list-style-type: none"> <li>• In the User Interface, enable the DATA COMMUNICATION SETTINGS/MAIN-AUXILIARY PORT\DATA TX parameter.</li> </ul>
<p><b>Communication:</b> data transferred to the host are incorrect, corrupted or incomplete.</p>	<ul style="list-style-type: none"> <li>• In the User Interface, select the DATA COMMUNICATION SETTINGS/DATA FORMAT folder and check for HEADER, TERMINATOR, SEPARATOR and FILL CHAR values.</li> <li>• Check the CODE FIELD LENGTH value.</li> <li>• Are the COM port parameters correctly assigned?</li> </ul>

**How do I obtain my units' serial numbers?**

- The device serial number is printed on a label that is affixed on the side of MSC 900 Controller.
- The serial number is also displayed when connecting the device through the User Interface.
- Serial numbers consist of 9 characters: one letter, 2 numbers, another letter followed by 5 numbers.

## 6 TECHNICAL FEATURES

<b>ELECTRICAL FEATURES</b>		
Supply Voltage	10 to 30 Vdc (typ. 24 Vdc)	
Power Consumption	0.5 A Max.	
Communication Interfaces	<b>Main (isolated)</b>	<b>Auxiliary</b>
	RS232 RS422 full-duplex	RS232
	<b>Other</b>	
	Ethernet	100 Mb/s
Communication Interfaces	Ethernet (quad) Profibus (MSC 900-1100 model)	100 Mb/s up to 12 Mb/s
Inputs (optocoupled NPN or PNP)	Trigger, Encoder/Tachometer, IN3, 3 polarity insensitive optocoupled inputs	
Outputs (optocoupled)	3 optocoupled outputs	
Input/Output	1 configurable Input/Output (PNP or NPN polarity insensitive optocoupled input, or optocoupled output)	
<b>USER INTERFACE</b>		
LCD Display	4 lines by 20 characters LCD	
Keypad	5 keys	
LED Indicators	POWER	STATUS
	TRIG	EBC
	SW-TRIG	OUT1
	ENC	OUT2
	IN3	OUT3
	IN4	OUT4
<b>SOFTWARE FEATURES</b>		
Configuration Modes	MSC 900 User Interface	
Parameter Storage	Non-volatile extractable SD-card	
<b>ENVIRONMENTAL FEATURES</b>		
Operating Temperature	0° to +50 °C (+32° to +122 °F)	
Storage Temperature	-20° to +70 °C (-4° to +158 °F)	
Humidity	90% non condensing	
Vibration Resistance EN 60068-2-6	14 mm @ 2 to 10 Hz; 1.5 mm @ 13 to 55 Hz; 2 g @ 70-500 Hz; 2 hours on each axis	
Shock Resistance EN 60068-2-27	30 g; 11 ms; 3 shocks on each axis	
Protection Class EN 60529	IP65*	
<b>PHYSICAL FEATURES</b>		
Mechanical Dimensions	192 x 157 x 74 mm (7.57 x 6.18 x 2.91 in)	
Weight	1.5 kg (3.31 lb)	

\* Sealed connectors required

# INDEX

---

## A

Active Controller Window 27  
Alarms 26  
Automatic Replacement Procedure 150

## B

Backup 144, 150  
Backup with MSC 900 Keypad 150  
Barcode Configuration  
    Code Collection 79  
    Logical Combination 71  
    Single Label 62  
    Standard Multi Label 65  
Barcode Configuration 61  
Barcode Settings Table 56  
Boot Loader 22

## C

CE Compliance vi  
Compliance vi  
Conveyor Speed Window 25

## D

Defaulting the MSC 900 22  
Device Settings  
    Device Info 131  
    Mounting 133  
    Options 135  
Device Settings 130  
Diagnostic Mask Window 23  
Diagnostics 121  
Diagnostics 137  
Diagnostics  
    Monitor 138  
Diagnostics  
    Read Test 140  
Diagnostics  
    Status Viewer 141  
Digital I/O 118

## E

e-Genius 29, 30  
Electrical  
    installation sequence recommended 152  
Electrical Connections 8  
Energy Saving 123  
Error Codes 153  
Ethernet  
    Ethernet IP 93  
    Line Settings 89  
    User Sockets 91  
    WebSentinel 94  
Ethernet 87

Ethernet Interface 13

## F

FCC Compliance vi  
Fieldbus 95

## G

General View vii  
Global Settings 38  
Guide to Installation viii

## H

Help 149  
HMI 128  
Human Machine Interface 128

## I

I/O Status Window 25  
Installation 5  
    sequence recommended 152  
Interfaces  
    Auxiliary 12  
    Main RS232 9  
    Main RS485 Full Duplex 10  
Introduction 1

## K

Keypad and Display 22

## L

Large Synchronized Network 15  
Last Code & Read Mask 26  
LED Indicators 3  
Logical Combination Rule 71

## M

Maintenance 150  
Mechanical Mounting 7  
Menu Functions, Getting to 22  
Menu Mode 27  
Messaging  
    Message Builder 105  
    Message Format 98  
    Pass Thru 114  
    Protocol Index 111  
    Statistics 109  
Messaging 98  
Model Description 3  
Modify Settings 34  
Monitor 138

## **O**

Operating Mode 39  
Overall Dimensions 6

## **P**

Package Contents 5  
PackTrack Calibration Wizard 134  
Pass Thru 114  
Product Description 1  
Profibus Interface 14

## **R**

Read Test 140  
Reading Mask Window 24  
Reading Performance Window 24  
Reboot 146  
REDS viii  
Redundancy Layout 18, 19, 20, 21  
Redundancy Mode 27  
Redundant Operation 128  
Redundant System viii  
Reference Documentation v  
Replacement Procedure 150  
Replacing an MSC 900 151  
Replacing the MSC 900 150  
Restore 144

## **S**

Serial Ports  
    Aux Port 86  
    Main Port 84  
Serial Ports 84  
Standard Mode 22  
Standby Controller Window 27  
Starting the User Interface 30  
Status Viewer 141  
System Info 35  
System Info Window 25

## **T**

Technical Features 161  
Text Entry Tool 32  
Troubleshooting 152  
Troubleshooting Guide 158  
Typical Layouts 15

## **U**

Update Firmware 147  
User Interface 29  
User Interface Basics 32  
Utilities 144

## **W**

WEBSITE v