



Figure can vary

Part no.: 50129411
PRK3CL1.A3/4T-M8
Polarized retro-reflective photoelectric sensor



Contents

- Technical data
- Dimensioned drawings
- Electrical connection
- Operation and display
- Reflectors & reflective tapes
- Part number code
- Notes
- Accessories

Technical data

Basic data	
Series	3C
Operating principle	Reflection principle
Special design	
Special design	Autocollimation Teach input
Optical data	
Operating range	Guaranteed operating range
Operating range	0 ... 2 m , With reflector MTKS 50x50.1
Operating range limit	Typical operating range
Operating range limit	0 ... 3 m , With reflector MTKS 50x50.1
Beam profile	Collimated
Light source	Laser , Red
Laser light wavelength	655 nm
Laser class	1 , IEC/EN 60825-1:2007
Max. laser power	0.0017 W
Transmitted-signal shape	Pulsed
Pulse duration	5.3 μ s
Light-spot size [at sensor distance]	1 mm [3,000 mm]
Type of light-spot geometry	Round
Shift angle	Typ. \pm 2°
Electrical data	
Protective circuit	Polarity reversal protection Short circuit protected
Performance data	
Supply voltage U_B	10 ... 30 V , DC , Incl. residual ripple
Residual ripple	0 ... 15 % , From U_B
Open-circuit current	0 ... 15 mA
Inputs	
Number of teach inputs	1 Piece(s)
Teach inputs	
Voltage type	DC
Switching voltage	high: $\geq 0,65 \times U_B$ low: $\leq 0,35 \times U_B$
Delay	1 ms
Input resistance	20,000 Ω
Teach input 1	
Assignment	Connection 1, pin 2
Function	Keyboard lockout Light/dark switching Sensitivity adjustment
Active switching state	High

Outputs

Number of digital switching outputs	1 Piece(s)
-------------------------------------	------------

Switching outputs

Voltage type	DC
Switching current, max.	100 mA
Switching voltage	High: $\geq(U_B-2V)$ Low: $\leq 2V$

Switching output 1

Assignment	Connection 1, pin 4
Switching element	Transistor , PNP
Switching principle	Light switching

Timing

Switching frequency	3,000 Hz
Response time	0.17 ms
Readiness delay	300 ms

Connection
Connection 1

Type of connection	Connector
Function	Signal IN Signal OUT Voltage supply
Thread size	M8
Type	Male
Material	Metal
No. of pins	4 -pin

Mechanical data

Dimension (W x H x L)	11.4 mm x 34.2 mm x 18.3 mm
Housing material	Plastic , PC-ABS
Lens cover material	Plastic / PMMA
Net weight	10 g
Housing color	Red
Type of fastening	Through-hole mounting Via optional mounting device
Compatibility of materials	ECOLAB

Operation and display

Type of display	LED
Number of LEDs	2 Piece(s)
Operational controls	Teach button
Function of the operational control	Sensitivity adjustment

Environmental data

Ambient temperature, operation	-40 ... 55 °C
Ambient temperature, storage	-40 ... 70 °C

Certifications

Degree of protection	IP 67 IP 69K
----------------------	-----------------

Part no.: 50129411 – PRK3CL1.A3/4T-M8 – Polarized retro-reflective

Protection class	III
Certifications	c UL US
Standards applied	IEC 60947-5-2

Classification

Customs tariff number	85365019
eCl@ss 8.0	27270902
eCl@ss 9.0	27270902
ETIM 5.0	EC002717
ETIM 6.0	EC002717

Dimensioned drawings

All dimensions in millimeters

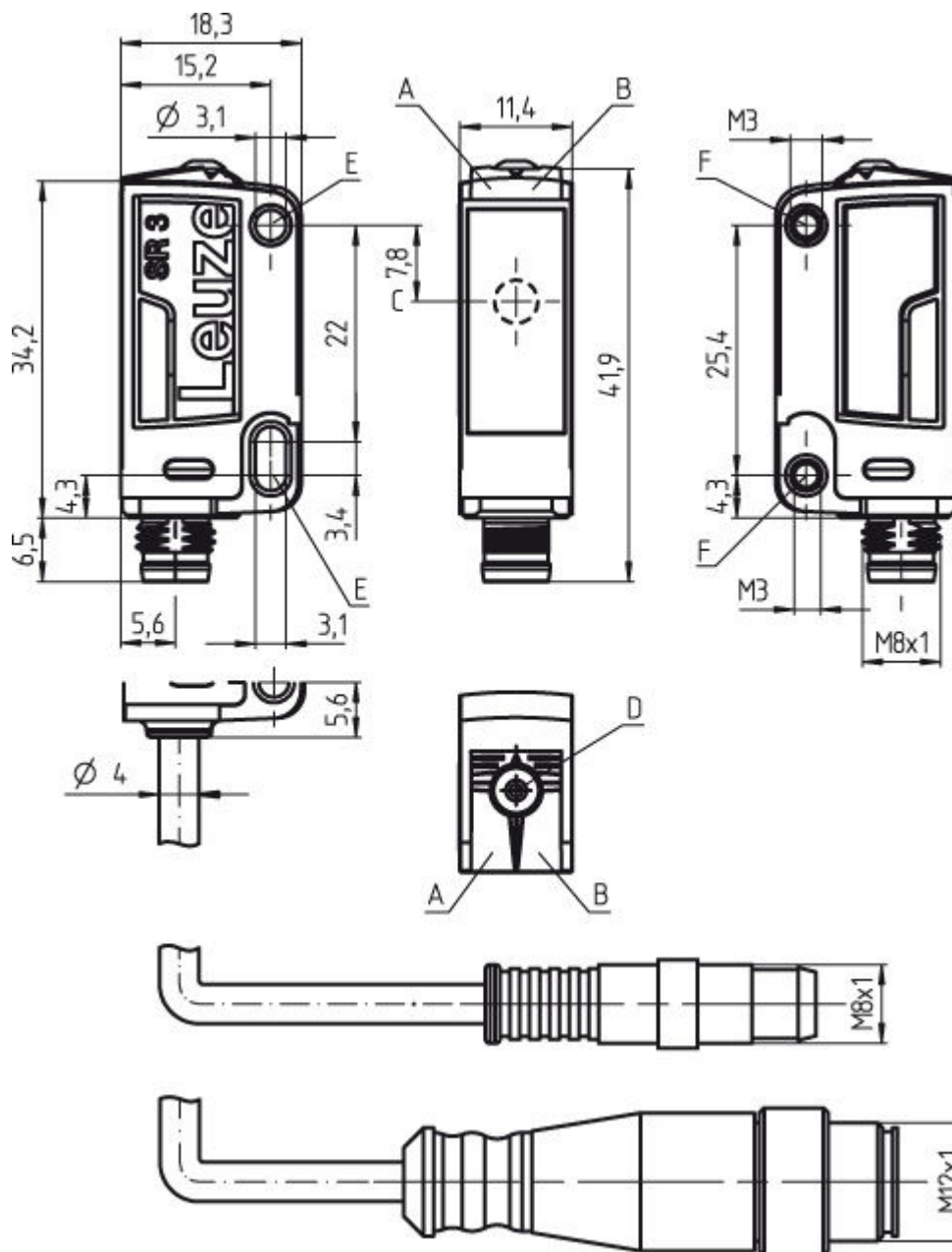

- A Green LED
- B Yellow LED
- C Optical axis
- D Teach button
- E Mounting sleeve (standard)
- F Threaded sleeve (3C.B series)

Electrical connection

Connection 1	
Type of connection	Connector
Function	Signal IN Signal OUT Voltage supply
Thread size	M8
Type	Male
Material	Metal
No. of pins	4 -pin
Encoding	

Pin	Pin assignment
1	VIN
2	Teach-in
3	GND
4	OUT 1

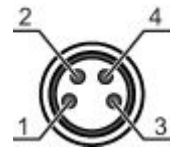

Operation and display



LEDs

LED	Display	Meaning
1	Green, continuous light	Operational readiness
2	Yellow, continuous light	Light path free
	Yellow, flashing	Light path free, no function reserve

Reflectors & reflective tapes

	Part no.	Designation	Operating range/ Operating range limit	Description
	50040894	MTKS 20x30	0 ... 1.6 m 0 ... 2.2 m	Design: Rectangular Reflective surface: 19 mm x 29 mm Triple reflector size: 1.2 mm Material: Plastic Base material: Plastic Chemical designation of the material: PMMA8N Fastening: Through-hole mounting, Adhesive

Part no.: 50129411 – PRK3CL1.A3/4T-M8 – Polarized retro-reflective

	Part no.	Designation	Operating range/ Operating range limit	Description
	50104130	MTKS 20x40.1	0 ... 1 m 0 ... 1.5 m	Design: Rectangular Reflective surface: 17 mm x 38 mm Triple reflector size: 12 mm Material: Plastic Base material: Plastic Chemical designation of the material: PMMA8N Fastening: Through-hole mounting, Adhesive
	50117583	MTKS 50x50.1	0 ... 2 m 0 ... 3 m	Design: Rectangular Reflective surface: 50 mm x 50 mm Triple reflector size: 1.2 mm Material: Plastic Base material: Plastic Chemical designation of the material: PMMA8N Fastening: Through-hole mounting, Adhesive
	50110192	REF 6-A-50x50	0 ... 1 m 0 ... 1.4 m	Design: Rectangular Reflective surface: 50 mm x 50 mm Triple reflector size: 0.3 mm Material: Plastic Chemical designation of the material: PMMA Fastening: Self-adhesive

Part number code

 Part designation: **AAA 3C d EE-f.GG H/i J-K**

AAA3C	Operating principle / construction: HT3C: diffuse reflection sensor with background suppression LS3C: throughbeam photoelectric sensor transmitter LE3C: throughbeam photoelectric sensor receiver PRK3C: retro-reflective photoelectric sensor with polarization filter
d	Light type: n/a: red light l: infrared light
EE	Light source: n/a: LED L1: laser class 1 L2: laser class 2
f	Pre-set range (optional): n/a: operating range acc. to data sheet XXXX: pre-set range [mm]
GG	Equipment: n/a: standard A: autocollimation principle (single lens) for positioning tasks B: housing model with two M3 threaded sleeves, brass F: permanently set range L: long light spot S: small light spot T: autocollimation principle (single lens) for highly transparent bottles without tracking TT: autocollimation principle (single lens) for highly transparent bottles with tracking V: V-optics XL: extra long light spot
H	Operating range adjustment: n/a with HT: range adjustable via 8-turn potentiometer n/a with retro-reflective photoelectric sensors (PRK): operating range not adjustable 1: 270° potentiometer 3: teach-in via button 6: auto-teach

i	Switching output/function OUT 1/IN: Pin 4 or black conductor: 2: NPN transistor output, light switching N: NPN transistor output, dark switching 4: PNP transistor output, light switching P: PNP transistor output, dark switching 6: push-pull switching output, PNP light switching, NPN dark switching G: push-pull switching output, PNP dark switching, NPN light switching /L: IO-Link 8: activation input (activation with high signal) X: pin not used
J	Switching output / function OUT 2/IN: pin 2 or white conductor: 2: NPN transistor output, light switching N: NPN transistor output, dark switching 4: PNP transistor output, light switching P: PNP transistor output, dark switching 6: push-pull switching output, PNP light switching, NPN dark switching G: push-pull switching output, PNP dark switching, NPN light switching W: warning output X: pin not used 8: activation input (activation with high signal) 9: deactivation input (deactivation with high signal) T: teach-in via cable
K	Electrical connection: n/a: cable, standard length 2000 mm, 4-wire 5000: cable, standard length 5000 mm, 4-wire M8: M8 connector, 4-pin (plug) M8.3: M8 connector, 3-pin (plug) 200-M8: cable, length 200 mm with M8 connector, 4-pin, axial (plug) 200-M8.3: cable, length 200 mm with M8 connector, 3-pin, axial (plug) 200-M12: cable, length 200 mm with M12 connector, 4-pin, axial (plug)

Note

A list with all available device types can be found on the Leuze electronic website at www.leuze.com.

Notes
Observe intended use!

- This product is not a safety sensor and is not intended as personnel protection.
- The product may only be put into operation by competent persons.
- Only use the product in accordance with its intended use.

For UL applications:

- For UL applications, use is only permitted in Class 2 circuits in accordance with the NEC (National Electric Code).
- These proximity switches shall be used with UL Listed Cable assemblies rated 30V, 0.5A min, in the field installation, or equivalent (categories: CYJV/CYJV7 or PVVA/PVVA7)

WARNING! LASER RADIATION – LASER CLASS 1

The device satisfies the requirements of IEC 60825-1:2007 (EN 60825-1:2007) safety regulations for a product of **laser class 1** as well as the U.S. 21 CFR 1040.10 regulations with deviations corresponding to "Laser Notice No. 50" from June 24, 2007.



- Observe the applicable statutory and local laser protection regulations.
- The device must not be tampered with and must not be changed in any way.
There are no user-serviceable parts inside the device.
Repairs must only be performed by Leuze electronic GmbH + Co. KG.

Part no.: 50129411 – PRK3CL1.A3/4T-M8 – Polarized retro-reflective

- Light source: Average life expectancy 50,000 h at an ambient temperature of 25 °C
- Response time: For short decay times, an ohmic load of approx. 5 kOhm is recommended
- Sum of the output currents for both outputs, 50 mA for ambient temperatures > 40 °C

Accessories

Connection technology - Connection cables

	Part no.	Designation	Article	Description
	50130850	KD U-M8-4A-V1-050	Connection cable	Connection 1: Connector, M8, Axial, Female, 4 -pin Connection 2: Open end Shielded: No Cable length: 5,000 mm Sheathing material: PVC
	50130871	KD U-M8-4W-V1-050	Connection cable	Connection 1: Connector, M8, Angled, Female, 4 -pin Connection 2: Open end Shielded: No Cable length: 5,000 mm Sheathing material: PVC

Mounting technology - Mounting brackets

	Part no.	Designation	Article	Description
	50060511	BT 3	Mounting device	Design of mounting device: Angle, L-shape Fastening, at system: Through-hole mounting Mounting bracket, at device: Screw type Type of mounting device: Rigid Material: Metal

Mounting technology - Rod mounts

	Part no.	Designation	Article	Description
	50117255	BTU 200M-D12	Mounting system	Contains: 2x M3 x 16 screw, 2x M3 x 20 screw, 2x position washers Design of mounting device: Mounting system Fastening, at system: For 12 mm rod, Sheet-metal mounting Mounting bracket, at device: Screw type Type of mounting device: Clampable, Adjustable, Turning, 360° Material: Metal

Micro-triad-type reflectors

	Part no.	Designation	Article	Description
	50104130	MTKS 20x40.1	Reflector	Design: Rectangular Reflective surface: 17 mm x 38 mm Triple reflector size: 12 mm Material: Plastic Base material: Plastic Chemical designation of the material: PMMA8N Fastening: Through-hole mounting, Adhesive

Part no.: 50129411 – PRK3CL1.A3/4T-M8 – Polarized retro-reflective

	Part no.	Designation	Article	Description
	50117583	MTKS 50x50.1	Reflector	Design: Rectangular Reflective surface: 50 mm x 50 mm Triple reflector size: 1.2 mm Material: Plastic Base material: Plastic Chemical designation of the material: PMMA8N Fastening: Through-hole mounting, Adhesive