



Figure can vary

Part no.: 50126548  
**SLS46C-70.K48-M12**  
Single beam safety device transmitter



## Contents

- Technical data
- Suitable receivers
- Dimensioned drawings
- Electrical connection
- Operation and display
- Accessories
- Notes

## Technical data

<b>Basic data</b>	
Series	46C
<b>Functions</b>	
Functions	Activation input
<b>Characteristic parameters</b>	
Type	4, IEC/EN 61496
MTTF <sub>d</sub>	900 years, EN ISO 13849-1
Mission time T <sub>M</sub>	20 years, EN ISO 13849-1
<b>Optical data</b>	
Operating range	5 ... 70 m
Operating range limit	5 ... 80 m
Light source	LED, Red
LED light wavelength	630 nm
Transmitted-signal shape	Pulsed
LED group	1
Opening angle, max.	-2.5 ... 2.5 °
<b>Electrical data</b>	
<b>Performance data</b>	
Supply voltage	24 V, DC, -20 ... 20 %, Incl. residual ripple
Residual ripple	10 %, From U <sub>B</sub>
Open-circuit current	0 ... 40 mA
<b>Inputs</b>	
Number of activation inputs	1 Piece(s)
<b>Activation inputs</b>	
Voltage type	DC
Switching voltage	high: ≥8V low: ≤1.5V
Switching voltage high, min.	8 V
Switching voltage low, max.	1.5 V
Activation/disable delay	1 ms
Input resistance	10,000 Ω, -30 ... 30 %
<b>Activation input 1</b>	
Assignment	Connection 1, pin 4
Active switching state	High
<b>Timing</b>	
Switching frequency	250 Hz
Response time	2.5 ms
Readiness delay	300 ms
<b>Connection</b>	
Number of connections	1 Piece(s)

Part no.: 50126548 – SLS46C-70.K48-M12 – Single beam safety device

**Connection 1**

Type of connection	Connector
Function	Signal IN Voltage supply
Thread size	M12
Material	Plastic
No. of pins	4 -pin

**Mechanical data**

Design	Cubic
Dimension (W x H x L)	20.5 mm x 76.3 mm x 44 mm
Housing material	Plastic, PC-PBT
Lens cover material	Plastic / PMMA
Net weight	50 g
Housing color	Yellow
Type of fastening	Through-hole mounting
Compatibility of materials	ECOLAB

**Operation and display**

Type of display	LED
Number of LEDs	2 Piece(s)

**Environmental data**

Ambient temperature, operation	-30 ... 60 °C
Ambient temperature, storage	-30 ... 70 °C

**Certifications**

Degree of protection	IP 69K IP 67
Protection class	III, Rating voltage 50 V
Certifications	c TÜV NRTL US c UL US
Standards applied	IEC 60947-5-2, IEC/EN 61496

**Classification**

eCl@ss 8.0	27272701
eCl@ss 9.0	27272701
ETIM 5.0	EC001831

**Suitable receivers**

	Part no.	Designation	Article	Description
	50126330	SLE46C-70.K4/ 4P-M12	Single beam safety device receiver	Response time: 2.5 ms Connection: Connector, M12, Plastic, 4 -pin

## Dimensioned drawings

All dimensions in millimeters

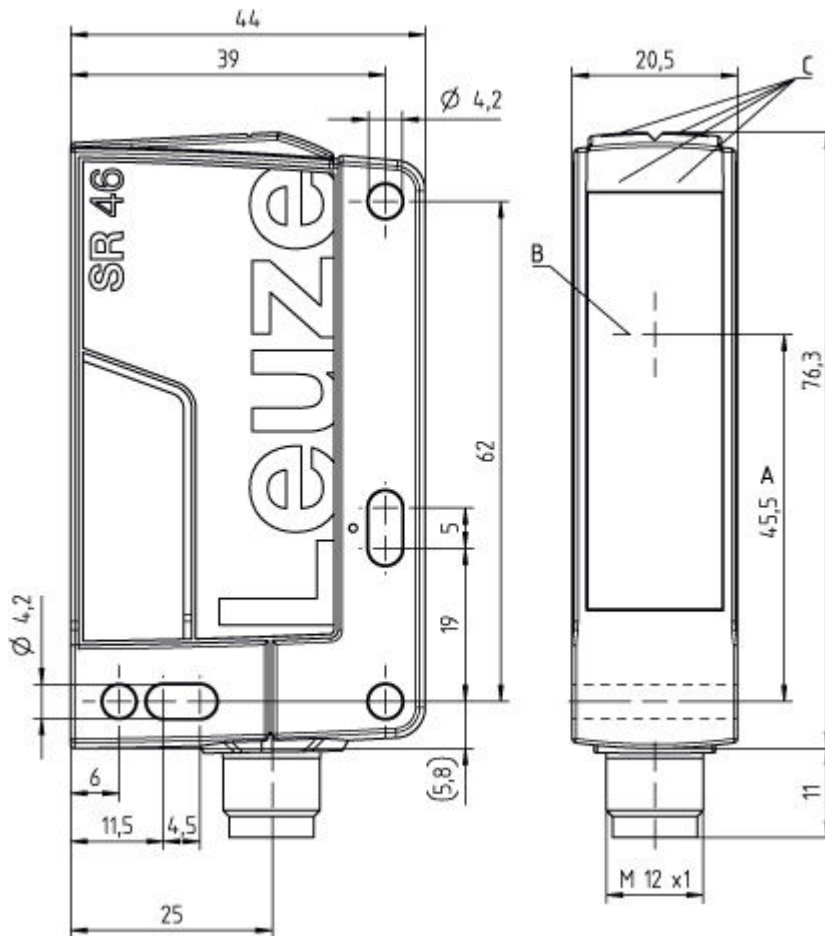

- A Optical axis
- B Transmitter and receiver
- C Green/yellow indicator diodes

## Electrical connection

Connection 1	
Type of connection	Connector
Function	Signal IN Voltage supply
Thread size	M12
Type	Male
Material	Plastic
No. of pins	4 -pin
Encoding	A-coded

Part no.: 50126548 – SLS46C-70.K48-M12 – Single beam safety device

Pin	Pin assignment	Conductor color
1	+24V	Brown
2	n.c.	White
3	GND	Blue
4	Active	Black

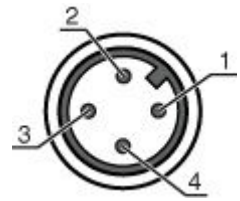





## Operation and display

### LEDs

LED	Display	Meaning
1	Green, continuous light	Ready
2	Yellow, continuous light	Transmitter activated

## Accessories

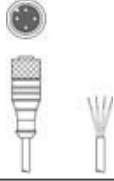
### Connection technology - Connection cables

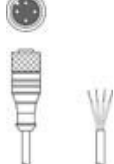

	Part no.	Designation	Article	Description
	50130654	KD U-M12-4A-P1-020	Connection cable	Connection 1: Connector, M12, Axial, Female, A-coded, 4 -pin Connection 2: Open end Shielded: No Cable length: 2,000 mm Sheathing material: PUR
	50130657	KD U-M12-4A-P1-050	Connection cable	Connection 1: Connector, M12, Axial, Female, A-coded, 4 -pin Connection 2: Open end Shielded: No Cable length: 5,000 mm Sheathing material: PUR
	50130658	KD U-M12-4A-P1-100	Connection cable	Connection 1: Connector, M12, Axial, Female, A-coded, 4 -pin Connection 2: Open end Shielded: No Cable length: 10,000 mm Sheathing material: PUR
	50130648	KD U-M12-4A-V1-020	Connection cable	Connection 1: Connector, M12, Axial, Female, A-coded, 4 -pin Connection 2: Open end Shielded: No Cable length: 2,000 mm Sheathing material: PVC
	50130652	KD U-M12-4A-V1-050	Connection cable	Connection 1: Connector, M12, Axial, Female, A-coded, 4 -pin Connection 2: Open end Shielded: No Cable length: 5,000 mm Sheathing material: PVC

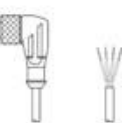
**Part no.: 50126548 – SLS46C-70.K48-M12 – Single beam safety device**

	Part no.	Designation	Article	Description
	50130653	KD U-M12-4A-V1-100	Connection cable	Connection 1: Connector, M12, Axial, Female, A-coded, 4 -pin Connection 2: Open end Shielded: No Cable length: 10,000 mm Sheathing material: PVC
	50132431	KD U-M12-4A-V1-200	Connection cable	Connection 1: Connector, M12, Axial, Female, A-coded, 4 -pin Connection 2: Open end Shielded: No Cable length: 20,000 mm Sheathing material: PVC
	50132430	KD U-M12-4A-V1-300	Connection cable	Connection 1: Connector, M12, Axial, Female, A-coded, 4 -pin Connection 2: Open end Shielded: No Cable length: 30,000 mm Sheathing material: PVC
	50130692	KD U-M12-4W-P1-020	Connection cable	Connection 1: Connector, M12, Angled, Female, A-coded, 4 -pin Connection 2: Open end Shielded: No Cable length: 2,000 mm Sheathing material: PUR
	50130694	KD U-M12-4W-P1-050	Connection cable	Connection 1: Connector, M12, Angled, Female, A-coded, 4 -pin Connection 2: Open end Shielded: No Cable length: 5,000 mm Sheathing material: PUR
	50130695	KD U-M12-4W-P1-100	Connection cable	Connection 1: Connector, M12, Angled, Female, A-coded, 4 -pin Connection 2: Open end Shielded: No Cable length: 10,000 mm Sheathing material: PUR
	50130688	KD U-M12-4W-V1-020	Connection cable	Connection 1: Connector, M12, Angled, Female, A-coded, 4 -pin Connection 2: Open end Shielded: No Cable length: 2,000 mm Sheathing material: PVC
	50130690	KD U-M12-4W-V1-050	Connection cable	Connection 1: Connector, M12, Angled, Female, A-coded, 4 -pin Connection 2: Open end Shielded: No Cable length: 5,000 mm Sheathing material: PVC
	50130691	KD U-M12-4W-V1-100	Connection cable	Connection 1: Connector, M12, Angled, Female, A-coded, 4 -pin Connection 2: Open end Shielded: No Cable length: 10,000 mm Sheathing material: PVC
	50132641	KD U-M12-4W-V1-200	Connection cable	Connection 1: Connector, M12, Angled, Female, A-coded, 4 -pin Connection 2: Open end Shielded: No Cable length: 20,000 mm Sheathing material: PVC

Part no.: 50126548 – SLS46C-70.K48-M12 – Single beam safety device

## Mounting technology - Mounting brackets

	Part no.	Designation	Article	Description
	50118543	BT 300M.5	Mounting bracket	Design of mounting device: Angle, L-shape Fastening, at system: Through-hole mounting Mounting bracket, at device: Screw type Type of mounting device: Adjustable Material: Stainless steel
	50105315	BT 46	Mounting device	Design of mounting device: Angle, L-shape Fastening, at system: Through-hole mounting Mounting bracket, at device: Screw type Type of mounting device: Rigid Material: Metal

## Mounting technology - Rod mounts

	Part no.	Designation	Article	Description
	50117253	BTU 300M-D10	Mounting system	Contains: 2x M4 x 25 screw, 2x M4 x 20 screw, 4x position washers Design of mounting device: Mounting system Fastening, at system: For 10 mm rod, Sheet-metal mounting Mounting bracket, at device: Screw type Type of mounting device: Clampable, Adjustable, Turning, 360° Material: Metal
	50117252	BTU 300M-D12	Mounting system	Contains: 2x M4 x 25 screw, 2x M4 x 20 screw, 4x position washers Design of mounting device: Mounting system Fastening, at system: For 12 mm rod, Sheet-metal mounting Mounting bracket, at device: Screw type Type of mounting device: Clampable, Adjustable, Turning, 360° Material: Metal
	50117251	BTU 300M-D14	Mounting system	Contains: 2x M4 x 25 screw, 2x M4 x 20 screw, 4x position washers Design of mounting device: Mounting system Fastening, at system: For 14 mm rod, Sheet-metal mounting Mounting bracket, at device: Screw type Type of mounting device: Clampable, Adjustable, Turning, 360° Material: Metal
	50120425	BTU 300M.5-D12	Mounting system	Contains: 2x M4 x 25 screw, 2x M4 x 20 screw, 2x position washers, 2x M4 mounting nut Design of mounting device: Mounting system Fastening, at system: For 12 mm rod, Sheet-metal mounting Mounting bracket, at device: Screw type Type of mounting device: Clampable, Adjustable, Turning, 360° Material: Stainless steel
	50119332	BTU 900M-D10	Mounting system	Contains: 2x M4 x 10 screw, 2x position washers Design of mounting device: Mounting system Fastening, at system: For 10 mm rod, Sheet-metal mounting Mounting bracket, at device: Screw type Type of mounting device: Clampable, Turning, 360°, Swiveling Material: Metal
	50119331	BTU 900M-D12	Mounting system	Contains: 2x position washers, 2x M4 x 10 screw Design of mounting device: Mounting system Fastening, at system: For 12 mm rod, Sheet-metal mounting Mounting bracket, at device: Screw type Type of mounting device: Clampable, Turning, 360°, Swiveling Material: Metal

**Part no.: 50126548 – SLS46C-70.K48-M12 – Single beam safety device**

	Part no.	Designation	Article	Description
	50119330	BTU 900M-D14	Mounting system	Contains: 2x position washers, 2x M4 x 10 screw Design of mounting device: Mounting system Fastening, at system: For 14 mm rod, Sheet-metal mounting Mounting bracket, at device: Screw type Type of mounting device: Clampable, Turning, 360°, Swiveling Material: Metal

**Mounting technology - Other**

	Part no.	Designation	Article	Description
	50136665	BTX 046M	Mounting plate	Contains: 2x M4 x 30 screw, 1 M4 x 12 screw Design of mounting device: Mounting plate Fastening, at system: Through-hole mounting Mounting bracket, at device: Screw type Material: Metal

**Alignment aids**

	Part no.	Designation	Article	Description
	50129659	ARH 46C	Alignment aid	Light source: laser, Red Housing material: Metal
	50109545	SAT 5	Alignment aid	Housing material: Metal

**Protective screens**

	Part no.	Designation	Article	Description
	50132604	SG 46C	Protective screen	Material: Glass

**Notes**

Observe intended use!
<ul style="list-style-type: none"> <li>The product may only be put into operation by competent persons.</li> <li>Only use the product in accordance with its intended use.</li> </ul>

Part no.: 50126548 – SLS46C-70.K48-M12 – Single beam safety device

**ATTENTION!**

- The SLS46CK4 safety sensors are a type 4 AOPD only in combination with the MSI-TRM safety relays.
- For mounting, electrical connection and operation, the operating instructions of the MSI-TRM safety relays are to be observed.

**For UL applications:**

- Certification: UL 508, C22.2 No.14-13
- Only for use in "class 2" circuits
- These proximity switches shall be used with UL Listed Cable assemblies rated 30V, 0.5A min, in the field installation, or equivalent (categories: CYJV/CYJV7 or PVVA/PVVA7)

- Typ. operating range limit: max. attainable range without function reserve
- Operating range: recommended range with function reserve
- Light source: Average life expectancy 100,000 h at an ambient temperature of 25 °C