



Part no.: 50117256
BTU 200M-D10
Mounting system



Figure can vary

Contents

- Technical data
- Dimensioned drawings
- Accessories

Technical data

Basic data	
Contains	2 M3 x 20 screws 2x M3 x 16 screw 2x position washers
Suitable for	18 series sensors 25B series sensors 25C series sensors 28 series sensors 3B series sensors 3C series sensors 5 series sensors 55 series sensors
Mechanical data	
Standard designation, metal mounting device	Aluminum Steel, galvanized
Design of mounting device	Mounting system
Type of fastening, at system	For 10 mm rod Sheet-metal mounting
Type of fastening, at device	Screw type
Type of mounting device	Adjustable Clampable Turning, 360°
Mounting device material	Metal
ITEM-compatible	No
Classification	
Customs tariff number	73182900
eCl@ss 8.0	27279202
eCl@ss 9.0	27273701
ETIM 5.0	EC003015
ETIM 6.0	EC003015

Dimensioned drawings

All dimensions in millimeters

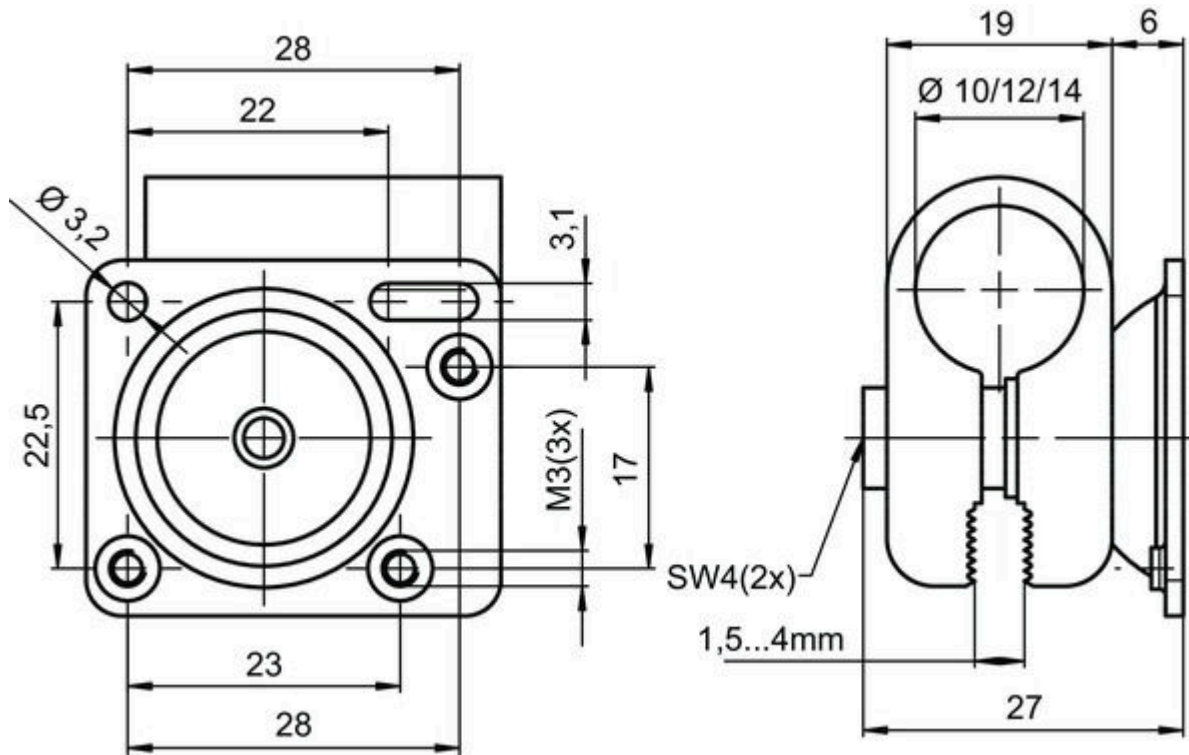

Accessories

Micro-triad-type reflectors

	Part no.	Designation	Article	Description
	50040895	MTKS 20x20	Reflector	Design: Rectangular Reflective surface: 20 mm x 20 mm Triple reflector size: 1.2 mm Material: Plastic Base material: Plastic Chemical designation of the material: PMMA8N Fastening: Through-hole mounting, Adhesive