



Part no.: 50114051
IS 208MM/4NO-2E0,200-S8.3
Inductive switch



Figure can vary

Contents

- . Technical data
- . Dimensioned drawings
- . Electrical connection
- . Diagrams
- . Operation and display
- . Part number code
- . Notes
- . Accessories

Technical data

Basic data	
Series	208
Typ. operating range limit S_n	2 mm
Operating range S_a	0 ... 1.6 mm
Characteristic parameters	
MTTF	900 years
Electrical data	
Protective circuit	Inductive protection Short circuit protected Polarity reversal protection
Performance data	
Supply voltage U_B	10 ... 30 V, DC
Residual ripple	0 ... 20 %, From U_B
Open-circuit current	0 ... 10 mA
Temperature drift, max. (in % of S_r)	10 %, Over the entire operating temperature range
Repeatability, max. (in % of S_r)	5 %, For $U_B = 20 \dots 30$ V DC, ambient temperature $T_a = 23 \text{ °C} \pm 5 \text{ °C}$
Switching hysteresis	10 %
Outputs	
Number of digital switching outputs	1 Piece(s)
Switching outputs	
Voltage type	DC
Switching current, max.	200 mA
Switching voltage	Low: ≤ 2 V
Residual current, max.	0.1 mA
Voltage drop	2 V
Switching output 1	
Switching element	Transistor, PNP
Switching principle	NO (normally open)
Timing	
Switching frequency	5,000 Hz
Readiness delay	32 ms
Connection	
Number of connections	1 Piece(s)

Connection 1

Type of connection	Cable with connector
Function	Voltage supply Signal OUT
Cable length	200 mm
Sheathing material	PUR
Cable color	Gray
Wire cross section	0.14 mm ²
Thread size	M8
Type	Male
Material	Stainless steel
No. of pins	3 -pin
Encoding	A-coded
Design	Axial

Mechanical data

Design	Cylindrical
Thread size	M8 x 1 mm
Dimension (Ø x L)	8 mm x 35 mm
Type of installation	Embedded
Housing material	Stainless steel, V2A
Sensing face material	Plastic, Polyamide (PA 12)
Net weight	28 g
Housing color	Silver Red, RAL 3000
Type of fastening	Via optional mounting device Mounting thread
Standard measuring plate	8 x 8 mm ² , Fe360

Operation and display

Type of display	LED
Number of LEDs	1 Piece(s)

Environmental data

Ambient temperature, operation	-25 ... 70 °C
Ambient temperature, storage	-25 ... 70 °C

Certifications

Degree of protection	IP 67
Protection class	III
Certifications	c UL US
Test procedure for EMC in accordance with standard	IEC 61000-4-3 IEC 61000-4-2 IEC 61000-4-4
Standards applied	IEC 60947-5-2

Correction factors

Aluminum	0.3
Stainless steel	0.7
Copper	0.3
Brass	0.45

Fe360 steel	1
-------------	---

Classification

Customs tariff number	85365019
eCl@ss 8.0	27270101
eCl@ss 9.0	27270101
ETIM 5.0	EC002714
ETIM 6.0	EC002714

Dimensioned drawings

All dimensions in millimeters

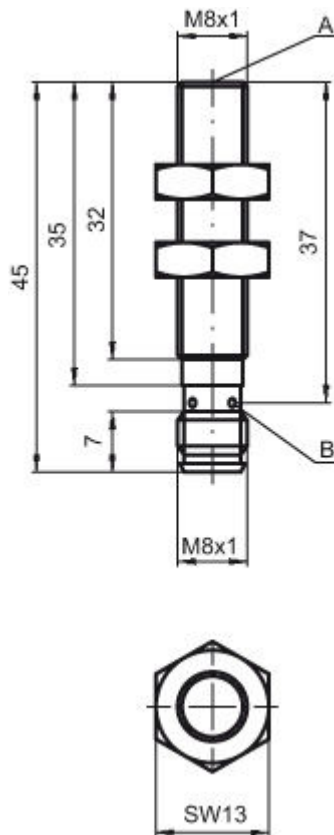

A Active surface
B Yellow LED

Electrical connection

Connection 1	
Type of connection	Cable with connector
Function	Voltage supply Signal OUT
Cable length	200 mm
Sheathing material	PUR

Connection 1	
Cable color	Gray
Wire cross section	0.14 mm ²
Thread size	M8
Type	Male
Material	Stainless steel
No. of pins	3 -pin
Encoding	A-coded
Design	Axial

Pin	Pin assignment
1	V+
3	GND
4	OUT 1

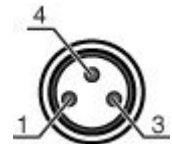

Diagrams

Embedded installation

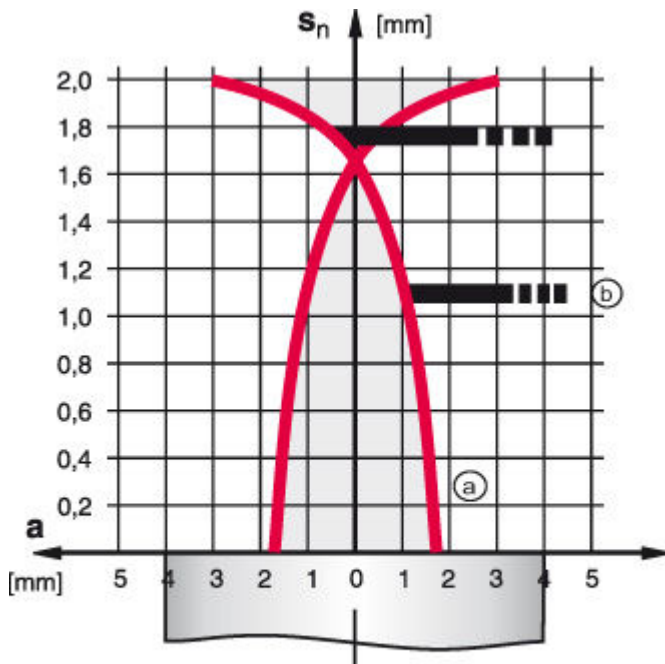

S_n [mm]	2
$D1$ [mm]	0
$D2$ [mm]	6
$D3$ [mm]	2

Types with $S_n = 2.0 \text{ mm}$

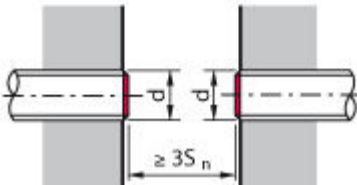
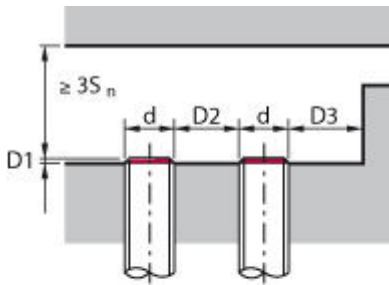

- a Inductive switch
b Standard measuring plate

Operation and display

LEDs

LED	Display	Meaning
1	Yellow, continuous light	Switching output/switching state

Part number code

Part designation: ISX YYY ZZ/AAA.BB-CCC-DDD-DDD

ISX	Operating principle / construction: IS: inductive switch, standard design ISS: inductive switch, short construction
YYY	Series: 203: series with $\varnothing 3 \text{ mm}$ 204: series with $\varnothing 4 \text{ mm}$ 205: series with M5 x 0.5 external thread 206: series with $\varnothing 6.5 \text{ mm}$ 208: series with M8 x 1 external thread 212: series with M12 x 1 external thread 218: series with M18 x 1 external thread 230: series with M30 x 1.5 external thread 240: series in cubic design 244: series in cubic design 255: series with 5 x 5 mm ² cross section 288: series with 8 x 8 mm ² cross section
ZZ	Housing / thread: MM: metal housing (active surface: plastic) / metric thread FM: full-metal housing (active surface: stainless steel AISI 316L) / metric thread MP: metal housing (active surface: plastic) / smooth (without thread)
AAA	Output current / supply: 4NO: PNP transistor, NO contact 4NC: PNP transistor, NC contact 2NO: NPN transistor, NO contact 2NC: NPN transistor, NC contact 1NO: relay, NO contact / AC/DC 1NC: relay, NC contact / AC/DC 44: 2 PNP transistor switching outputs, antivalent (NO + NC)

Part no.: 50114051 – IS 208MM/4NO-2E0,200-S8.3 – Inductive switch

BB	Special equipment: n/a: no special equipment 5F: food version 5: housing material V2A (1.4305, AISI 303)
CCC	Measurement range / type of installation: 1E0: typ. range limit 1.0 mm / embedded installation 1E5: typ. range limit 1.5 mm / embedded installation 2E0: typ. range limit 2.0 mm / embedded installation 3E0: typ. range limit 3.0 mm / embedded installation 4E0: typ. range limit 4.0 mm / embedded installation 5E0: typ. range limit 5.0 mm / embedded installation 6E0: typ. range limit 6.0 mm / embedded installation 8E0: typ. range limit 8.0 mm / embedded installation 10E: typ. range limit 10.0 mm / embedded installation 12E: typ. range limit 12.0 mm / embedded installation 20E: typ. range limit 20.0 mm / embedded installation 22E: typ. range limit 22.0 mm / embedded installation 2N5: typ. range limit 2.5 mm / non-embedded installation 4N0: typ. range limit 4.0 mm / non-embedded installation 8N0: typ. range limit 8.0 mm / non-embedded installation 10N: typ. range limit 10.0 mm / non-embedded installation 12N: typ. range limit 12.0 mm / non-embedded installation 15N: typ. range limit 15.0 mm / non-embedded installation 20N: typ. range limit 20.0 mm / non-embedded installation 25N: typ. range limit 25.0 mm / non-embedded installation 40N: typ. range limit 40.0 mm / non-embedded installation
DDD	Electrical connection: n/a: cable, PVC, standard length 2000 mm S12: M12 connector, 4-pin, axial 200-S12: cable, PVC, length 200 mm with M12 connector, 4-pin, axial 200-S8.3: cable, PVC, length 200 mm with M8 connector, 3-pin, axial S8.3: M8 connector, 3-pin, axial 005-S8.3: cable, PVC, length 500 mm with M8 connector, 3-pin, axial

Note

A list with all available device types can be found on the Leuze electronic website at www.leuze.com.

Notes
Observe intended use!

- This product is not a safety sensor and is not intended as personnel protection.
- The product may only be put into operation by competent persons.
- Only use the product in accordance with its intended use.





For UL applications:

- For UL applications, use is only permitted in Class 2 circuits in accordance with the NEC (National Electric Code).

Accessories
Connection technology - Connection cables

	Part no.	Designation	Article	Description
	50130842	KD U-M8-3A-P1-020	Connection cable	Connection 1: Connector, M8, Axial, Female, 3 -pin Connection 2: Open end Shielded: No Cable length: 2,000 mm Sheathing material: PUR

Part no.: 50114051 – IS 208MM/4NO-2E0,200-S8.3 – Inductive switch



	Part no.	Designation	Article	Description
	50130844	KD U-M8-3A-P1-050	Connection cable	Connection 1: Connector, M8, Axial, Female, 3 -pin Connection 2: Open end Shielded: No Cable length: 5,000 mm Sheathing material: PUR
	50130837	KD U-M8-3A-V1-020	Connection cable	Connection 1: Connector, M8, Axial, Female, 3 -pin Connection 2: Open end Shielded: No Cable length: 2,000 mm Sheathing material: PVC
	50130832	KD U-M8-3A-V1-050	Connection cable	Connection 1: Connector, M8, Axial, Female, 3 -pin Connection 2: Open end Shielded: No Cable length: 5,000 mm Sheathing material: PVC
	50130865	KD U-M8-3W-P1-020	Connection cable	Connection 1: Connector, M8, Angled, Female, 3 -pin Connection 2: Open end Shielded: No Cable length: 2,000 mm Sheathing material: PUR
	50130867	KD U-M8-3W-P1-050	Connection cable	Connection 1: Connector, M8, Angled, Female, 3 -pin Connection 2: Open end Shielded: No Cable length: 5,000 mm Sheathing material: PUR
	50130860	KD U-M8-3W-V1-020	Connection cable	Connection 1: Connector, M8, Angled, Female, 3 -pin Connection 2: Open end Shielded: No Cable length: 2,000 mm Sheathing material: PVC
	50130862	KD U-M8-3W-V1-050	Connection cable	Connection 1: Connector, M8, Angled, Female, 3 -pin Connection 2: Open end Shielded: No Cable length: 5,000 mm Sheathing material: PVC

Mounting technology - Mounting brackets

	Part no.	Designation	Article	Description
	50113550	BT D08M.5	Mounting bracket	Diameter, inner: 8 mm Design of mounting device: Angle, L-shape Fastening, at system: Through-hole mounting Mounting bracket, at device: Screw type Type of mounting device: Rigid Material: Stainless steel

Part no.: 50114051 – IS 208MM/4NO-2E0,200-S8.3 – Inductive switch

Mounting technology - Other

	Part no.	Designation	Article	Description
	50132727	AC D08M-CS	Clamp	Contains: 2x M12 mounting nut Diameter, inner: 8 mm Design of mounting device: Mounting clamp Fastening, at system: Screw type, Through-hole mounting Mounting bracket, at device: insertable, Clampable with limit stop Type of mounting device: Clampable, With limit stop Material: Metal
	50111497	MC 008K	Clamp	Diameter, inner: 8 mm Design of mounting device: Mounting clamp Fastening, at system: Through-hole mounting Mounting bracket, at device: Clampable Type of mounting device: Rigid Material: Plastic
	50111498	MC 008K-LS	Clamp	Diameter, inner: 8 mm Design of mounting device: Mounting clamp Fastening, at system: Through-hole mounting Mounting bracket, at device: Clampable with limit stop Type of mounting device: Rigid Material: Plastic