



Figure can vary

Part no.: 50112890
IS 288MP/4NO-3E0-S8.3
Inductive switch



Contents

- Technical data
- Dimensioned drawings
- Electrical connection
- Diagrams
- Operation and display
- Part number code
- Notes
- Accessories

Technical data

Basic data	
Series	288
Typ. operating range limit S_n	3 mm
Operating range S_a	0 ... 2.4 mm
Characteristic parameters	
MTTF	1,050 years
Electrical data	
Protective circuit	Polarity reversal protection Inductive protection Short circuit protected
Performance data	
Supply voltage U_B	10 ... 30 V, DC
Residual ripple	0 ... 20 %, From U_B
Open-circuit current	0 ... 10 mA
Temperature drift, max. (in % of S_r)	10 %, Over the entire operating temperature range
Repeatability, max. (in % of S_r)	5 %, For $U_B = 20 \dots 30$ V DC, ambient temperature $T_a = 23 \text{ °C} \pm 5 \text{ °C}$
Switching hysteresis	10 %
Outputs	
Number of digital switching outputs	1 Piece(s)
Switching outputs	
Voltage type	DC
Switching current, max.	200 mA
Switching voltage	Low: ≤ 2 V
Residual current, max.	0.1 mA
Voltage drop	2 V
Switching output 1	
Switching element	Transistor, PNP
Switching principle	NO (normally open)

Timing	
Switching frequency	1,000 Hz
Readiness delay	50 ms

Connection	
Number of connections	1 Piece(s)
Connection 1	
Type of connection	Connector
Function	Signal OUT Voltage supply
Thread size	M8
Type	Male
Material	Metal
No. of pins	3 -pin
Encoding	A-coded

Part no.: 50112890 – IS 288MP/4NO-3E0-S8.3 – Inductive switch

Mechanical data	
Design	Cubic
Dimension (W x H x L)	8 mm x 8 mm x 59 mm
Type of installation	Embedded
Housing material	Metal, ZAMAK
Sensing face material	Plastic, Polybutylene (PBT)
Net weight	24 g
Housing color	Silver Red, RAL 3000
Type of fastening	Through-hole mounting
Standard measuring plate	9 x 9 mm ² , Fe360

Operation and display	
Type of display	LED
Number of LEDs	1 Piece(s)

Environmental data	
Ambient temperature, operation	-25 ... 70 °C
Ambient temperature, storage	-25 ... 70 °C

Certifications	
Degree of protection	IP 67
Protection class	III
Certifications	c UL US
Test procedure for EMC in accordance with standard	IEC 61000-4-4 IEC 61000-4-3 IEC 61000-4-2
Standards applied	IEC 60947-5-2

Correction factors	
Aluminum	0.36
Stainless steel	0.77
Copper	0.27
Brass	0.45
Fe360 steel	1

Classification	
Customs tariff number	85365019
eCl@ss 8.0	27270101
eCl@ss 9.0	27270101
ETIM 5.0	EC002714
ETIM 6.0	EC002714

Dimensioned drawings

All dimensions in millimeters

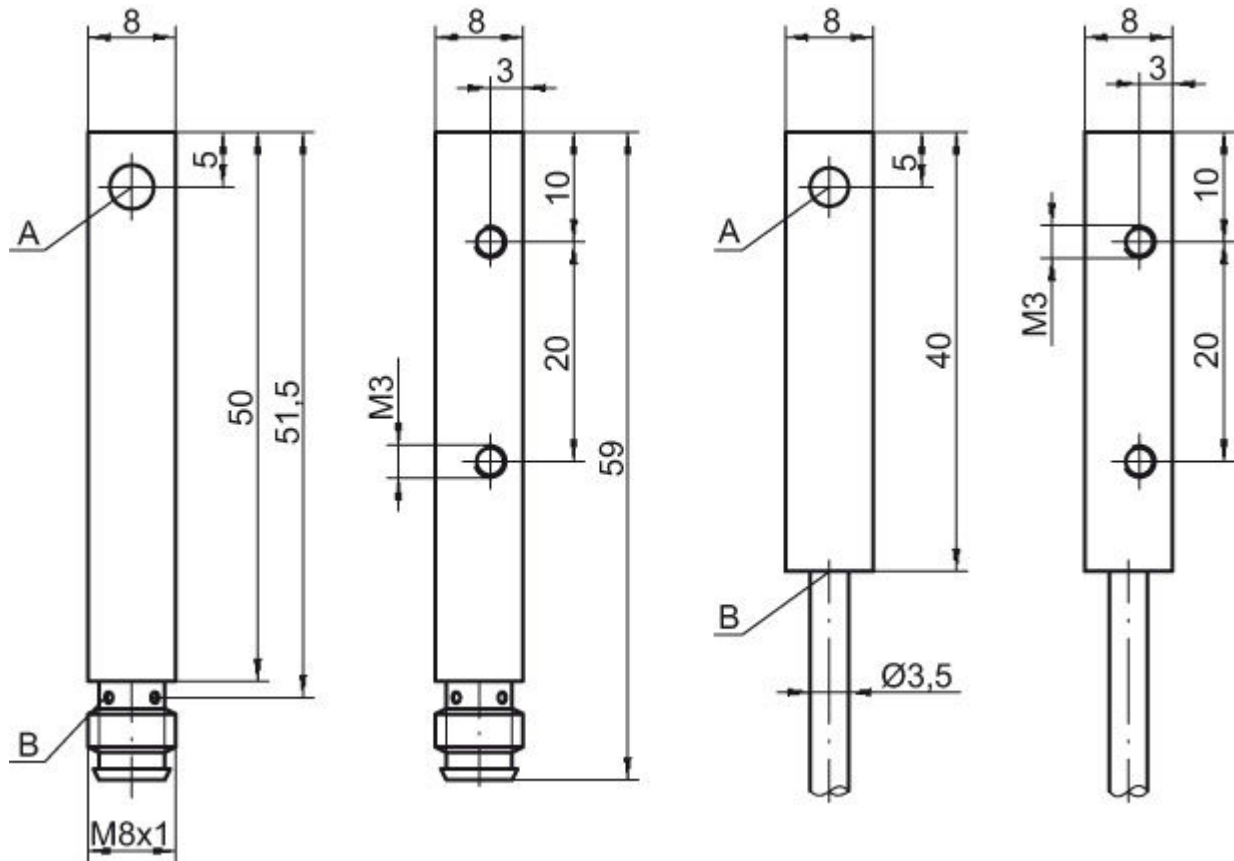

A Active surface
B Yellow LED

Electrical connection

Connection 1	
Type of connection	Connector
Function	Signal OUT Voltage supply
Thread size	M8
Type	Male
Material	Metal
No. of pins	3 -pin
Encoding	A-coded

Pin	Pin assignment
1	V+
3	GND
4	OUT 1

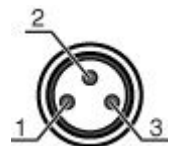

Diagrams

Embedded installation

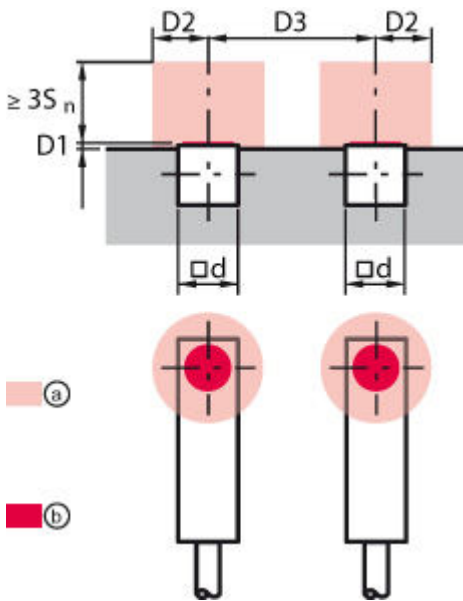

S_n [mm]	3
$D1$ [mm]	1
$D2$ [mm]	6
$D3$ [mm]	16
a	Metal-free space
b	Active surface

Types with $S_n = 3.0$ mm

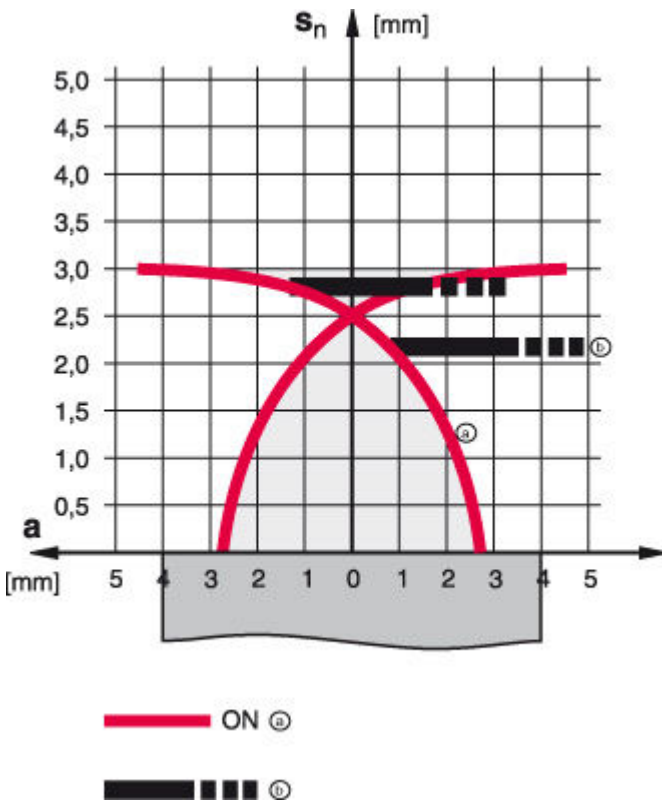

- a Inductive switch
- b Standard measuring plate

Operation and display

LEDs

LED	Display	Meaning
1	Yellow, continuous light	Switching output/switching state

Part number code

Part designation: ISX YYY ZZ/AAA.BB-CCC-DDD-DDD

ISX	Operating principle / construction: IS: inductive switch, standard design ISS: inductive switch, short construction
YYY	Series: 203: series with Ø 3 mm 204: series with Ø 4 mm 205: series with M5 x 0.5 external thread 206: series with Ø 6.5 mm 208: series with M8 x 1 external thread 212: series with M12 x 1 external thread 218: series with M18 x 1 external thread 230: series with M30 x 1.5 external thread 240: series in cubic design 244: series in cubic design 255: series with 5 x 5 mm ² cross section 288: series with 8 x 8 mm ² cross section
ZZ	Housing / thread: MM: metal housing (active surface: plastic) / metric thread FM: full-metal housing (active surface: stainless steel AISI 316L) / metric thread MP: metal housing (active surface: plastic) / smooth (without thread)
AAA	Output current / supply: 4NO: PNP transistor, NO contact 4NC: PNP transistor, NC contact 2NO: NPN transistor, NO contact 2NC: NPN transistor, NC contact 1NO: relay, NO contact / AC/DC 1NC: relay, NC contact / AC/DC 44: 2 PNP transistor switching outputs, antivalent (NO + NC)
BB	Special equipment: n/a: no special equipment 5F: food version 5: housing material V2A (1.4305, AISI 303)
CCC	Measurement range / type of installation: 1E0: typ. range limit 1.0 mm / embedded installation 1E5: typ. range limit 1.5 mm / embedded installation 2E0: typ. range limit 2.0 mm / embedded installation 3E0: typ. range limit 3.0 mm / embedded installation 4E0: typ. range limit 4.0 mm / embedded installation 5E0: typ. range limit 5.0 mm / embedded installation 6E0: typ. range limit 6.0 mm / embedded installation 8E0: typ. range limit 8.0 mm / embedded installation 10E: typ. range limit 10.0 mm / embedded installation 12E: typ. range limit 12.0 mm / embedded installation 20E: typ. range limit 20.0 mm / embedded installation 20E: typ. range limit 20.0 mm / embedded installation 22E: typ. range limit 22.0 mm / embedded installation 2N5: typ. range limit 2.5 mm / non-embedded installation 4N0: typ. range limit 4.0 mm / non-embedded installation 8N0: typ. range limit 8.0 mm / non-embedded installation 10N: typ. range limit 10.0 mm / non-embedded installation 12N: typ. range limit 12.0 mm / non-embedded installation 20N: typ. range limit 20.0 mm / non-embedded installation 15N: typ. range limit 15.0 mm / non-embedded installation 20N: typ. range limit 20.0 mm / non-embedded installation 25N: typ. range limit 25.0 mm / non-embedded installation 40N: typ. range limit 40.0 mm / non-embedded installation

Part no.: 50112890 – IS 288MP/4NO-3E0-S8.3 – Inductive switch

DDD	Electrical connection: n/a: cable, PVC, standard length 2000 mm S12: M12 connector, 4-pin, axial 200-S12: cable, PVC, length 200 mm with M12 connector, 4-pin, axial 200-S8.3: cable, PVC, length 200 mm with M8 connector, 3-pin, axial S8.3: M8 connector, 3-pin, axial 005-S8.3: cable, PVC, length 500 mm with M8 connector, 3-pin, axial
-----	--

Note
A list with all available device types can be found on the Leuze electronic website at www.leuze.com .





Notes

Observe intended use!
<ul style="list-style-type: none"> This product is not a safety sensor and is not intended as personnel protection. The product may only be put into operation by competent persons. Only use the product in accordance with its intended use.



For UL applications:
<ul style="list-style-type: none"> For UL applications, use is only permitted in Class 2 circuits in accordance with the NEC (National Electric Code).

Accessories

Connection technology - Connection cables

	Part no.	Designation	Article	Description
	50130842	KD U-M8-3A-P1-020	Connection cable	Connection 1: Connector, M8, Axial, Female, 3 -pin Connection 2: Open end Shielded: No Cable length: 2,000 mm Sheathing material: PUR
	50130844	KD U-M8-3A-P1-050	Connection cable	Connection 1: Connector, M8, Axial, Female, 3 -pin Connection 2: Open end Shielded: No Cable length: 5,000 mm Sheathing material: PUR
	50130837	KD U-M8-3A-V1-020	Connection cable	Connection 1: Connector, M8, Axial, Female, 3 -pin Connection 2: Open end Shielded: No Cable length: 2,000 mm Sheathing material: PVC
	50130832	KD U-M8-3A-V1-050	Connection cable	Connection 1: Connector, M8, Axial, Female, 3 -pin Connection 2: Open end Shielded: No Cable length: 5,000 mm Sheathing material: PVC

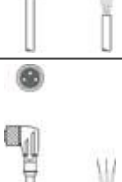

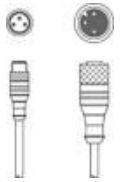

Part no.: 50112890 – IS 288MP/4NO-3E0-S8.3 – Inductive switch

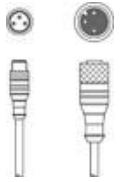
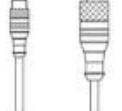
	Part no.	Designation	Article	Description
	50130865	KD U-M8-3W-P1-020	Connection cable	Connection 1: Connector, M8, Angled, Female, 3 -pin Connection 2: Open end Shielded: No Cable length: 2,000 mm Sheathing material: PUR
	50130866	KD U-M8-3W-P1-030	Connection cable	Connection 1: Connector, M8, Angled, Female, 3 -pin Connection 2: Open end Shielded: No Cable length: 3,000 mm Sheathing material: PUR
	50130867	KD U-M8-3W-P1-050	Connection cable	Connection 1: Connector, M8, Angled, Female, 3 -pin Connection 2: Open end Shielded: No Cable length: 5,000 mm Sheathing material: PUR
	50130860	KD U-M8-3W-V1-020	Connection cable	Connection 1: Connector, M8, Angled, Female, 3 -pin Connection 2: Open end Shielded: No Cable length: 2,000 mm Sheathing material: PVC
	50130861	KD U-M8-3W-V1-030	Connection cable	Connection 1: Connector, M8, Angled, Female, 3 -pin Connection 2: Open end Shielded: No Cable length: 3,000 mm Sheathing material: PVC
	50130862	KD U-M8-3W-V1-050	Connection cable	Connection 1: Connector, M8, Angled, Female, 3 -pin Connection 2: Open end Shielded: No Cable length: 5,000 mm Sheathing material: PVC
	50130932	KDS U-M8-3A-M12-3A-P1-050	Interconnection cable	Connection 1: Connector, M8, Axial, Female, 3 -pin Connection 2: Connector, M12, Axial, Male, A-coded, 3 -pin Shielded: No Cable length: 5,000 mm Sheathing material: PUR

Connection technology - Interconnection cables

	Part no.	Designation	Article	Description
	50130931	KDS U-M8-3A-M12-3A-P1-020	Interconnection cable	Connection 1: Connector, M8, Axial, Female, 3 -pin Connection 2: Connector, M12, Axial, Male, A-coded, 3 -pin Shielded: No Cable length: 2,000 mm Sheathing material: PUR
	50130932	KDS U-M8-3A-M12-3A-P1-050	Interconnection cable	Connection 1: Connector, M8, Axial, Female, 3 -pin Connection 2: Connector, M12, Axial, Male, A-coded, 3 -pin Shielded: No Cable length: 5,000 mm Sheathing material: PUR

Part no.: 50112890 – IS 288MP/4NO-3E0-S8.3 – Inductive switch

	Part no.	Designation	Article	Description
	50130905	KDS U-M8-3A-M8-3A-P1-020	Interconnection cable	Connection 1: Connector, M8, Axial, Female, 3 -pin Connection 2: Connector, M8, Axial, Male, 3 -pin Shielded: No Cable length: 2,000 mm Sheathing material: PUR
	50130907	KDS U-M8-3A-M8-3A-P1-050	Interconnection cable	Connection 1: Connector, M8, Axial, Female, 3 -pin Connection 2: Connector, M8, Axial, Male, 3 -pin Shielded: No Cable length: 5,000 mm Sheathing material: PUR
	50130900	KDS U-M8-3A-M8-3A-V1-020	Interconnection cable	Connection 1: Connector, M8, Axial, Female, 3 -pin Connection 2: Connector, M8, Axial, Male, 3 -pin Shielded: No Cable length: 2,000 mm Sheathing material: PVC
	50130920	KDS U-M8-3W-M8-3A-P1-020	Interconnection cable	Connection 1: Connector, M8, Angled, Female, 3 -pin Connection 2: Connector, M8, Axial, Male, 3 -pin Shielded: No Cable length: 2,000 mm Sheathing material: PUR