



Part no.: 50111871
IS 230MM/4NC-10E-S12
Inductive switch



Figure can vary

Contents

- Technical data
- Dimensioned drawings
- Electrical connection
- Diagrams
- Operation and display
- Part number code
- Notes
- Accessories

Technical data

| Basic data | |
|--|--|
| Series | 230 |
| Typ. operating range limit S_n | 10 mm |
| Operating range S_a | 0 ... 8.1 mm |
| Characteristic parameters | |
| MTTF | 930 years |
| Electrical data | |
| Protective circuit | Inductive protection Short circuit protected Polarity reversal protection |
| Performance data | |
| Supply voltage U_B | 10 ... 30 V, DC |
| Residual ripple | 0 ... 20 %, From U_B |
| Open-circuit current | 0 ... 10 mA |
| Temperature drift, max. (in % of S_r) | 10 %, Over the entire operating temperature range |
| Repeatability, max. (in % of S_r) | 5 %, For $U_B = 20 \dots 30$ V DC, ambient temperature $T_a = 23 \text{ °C} \pm 5 \text{ °C}$ |
| Switching hysteresis | 20 % |
| Outputs | |
| Number of digital switching outputs | 1 Piece(s) |
| Switching outputs | |
| Voltage type | DC |
| Switching current, max. | 200 mA |
| Switching voltage | Low: ≤ 2 V |
| Residual current, max. | 0.1 mA |
| Voltage drop | 2 V |
| Switching output 1 | |
| Switching element | Transistor, PNP |
| Switching principle | NC (normally closed) |

| Timing | |
|---------------------|----------|
| Switching frequency | 1,200 Hz |
| Readiness delay | 70 ms |

| Connection | |
|-----------------------|------------------------------|
| Number of connections | 1 Piece(s) |
| Connection 1 | |
| Type of connection | Connector |
| Function | Signal OUT Voltage supply |
| Thread size | M12 |
| Type | Male |
| Material | Metal |
| No. of pins | 4 -pin |
| Encoding | A-coded |

Part no.: 50111871 – IS 230MM/4NC-10E-S12 – Inductive switch

| Mechanical data | |
|--|---|
| Design | Cylindrical |
| Thread size | M30 x 1.5 mm |
| Dimension (Ø x L) | 30 mm x 63.5 mm |
| Type of installation | Embedded |
| Housing material | Metal, Nickel-plated brass |
| Sensing face material | Plastic, Polybutylene (PBT) |
| Net weight | 130 g |
| Housing color | Silver Red, RAL 3000 |
| Type of fastening | Mounting thread |
| Standard measuring plate | 30 x 30 mm ² , Fe360 |
| Operation and display | |
| Type of display | LED |
| Number of LEDs | 1 Piece(s) |
| Environmental data | |
| Ambient temperature, operation | -25 ... 70 °C |
| Ambient temperature, storage | -25 ... 70 °C |
| Certifications | |
| Degree of protection | IP 67 |
| Protection class | II |
| Certifications | c UL US |
| Test procedure for EMC in accordance with standard | IEC 61000-4-4 IEC 61000-4-2 IEC 61000-4-3 |
| Standards applied | IEC 60947-5-2 |
| Correction factors | |
| Aluminum | 0.45 |
| Stainless steel | 0.8 |
| Copper | 0.4 |
| Brass | 0.55 |
| Fe360 steel | 1 |
| Classification | |
| Customs tariff number | 85365019 |
| eCl@ss 8.0 | 27270101 |
| eCl@ss 9.0 | 27270101 |
| ETIM 5.0 | EC002714 |
| ETIM 6.0 | EC002714 |

Dimensioned drawings

All dimensions in millimeters

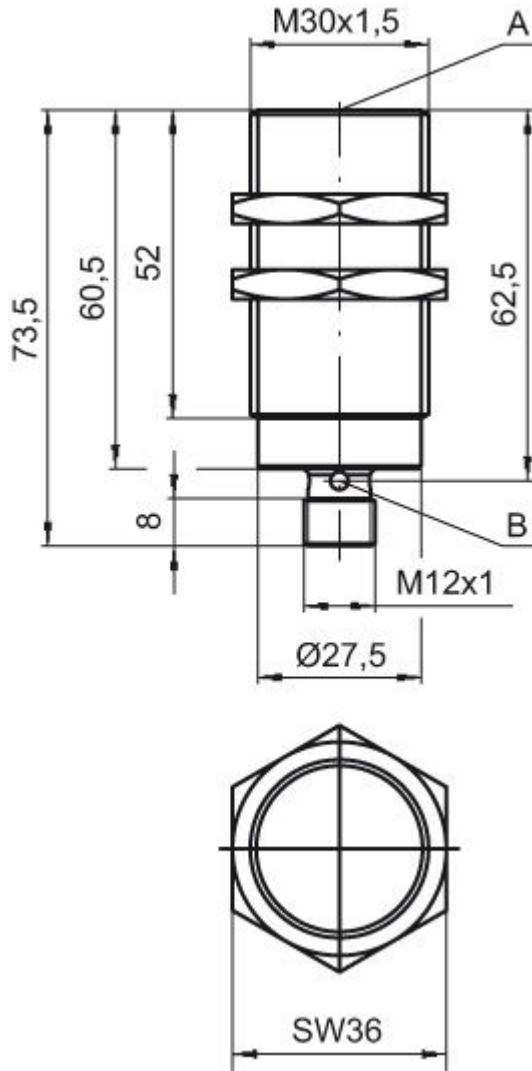

A Active surface
B Yellow LED

Electrical connection

| Connection 1 | |
|--------------------|------------------------------|
| Type of connection | Connector |
| Function | Signal OUT Voltage supply |
| Thread size | M12 |
| Type | Male |
| Material | Metal |
| No. of pins | 4 -pin |
| Encoding | A-coded |

| Pin | Pin assignment |
|-----|----------------|
| 1 | V+ |
| 2 | OUT 1 |
| 3 | GND |

| Pin | Pin assignment |
|-----|----------------|
| 4 | n.c. |

Diagrams

Embedded installation

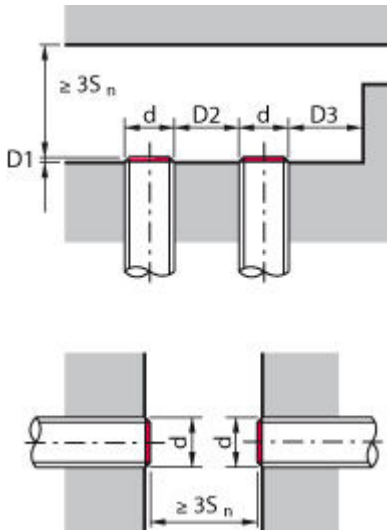

| | |
|------------|----|
| S_n [mm] | 10 |
| $D1$ [mm] | 0 |
| $D2$ [mm] | 30 |
| $D3$ [mm] | 10 |

Types with $S_n = 10.0$ mm

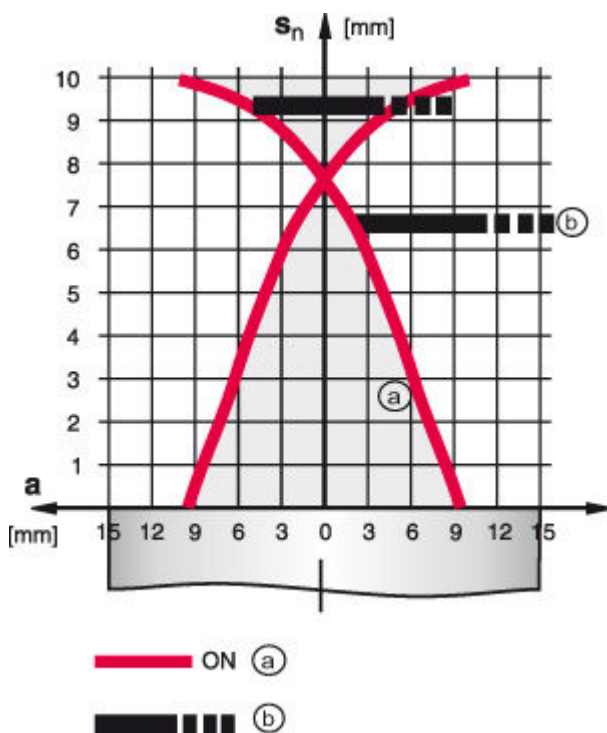

- a Inductive switch
- b Standard measuring plate

Operation and display

LEDs

| LED | Display | Meaning |
|-----|--------------------------|----------------------------------|
| 1 | Yellow, continuous light | Switching output/switching state |

Part number code

Part designation: ISX YYY ZZ/AAA.BB-CCC-DDD-DDD

| | |
|-----|--|
| ISX | Operating principle / construction: IS: inductive switch, standard design ISS: inductive switch, short construction |
| YYY | Series: 203: series with Ø 3 mm 204: series with Ø 4 mm 205: series with M5 x 0.5 external thread 206: series with Ø 6.5 mm 208: series with M8 x 1 external thread 212: series with M12 x 1 external thread 218: series with M18 x 1 external thread 230: series with M30 x 1.5 external thread 240: series in cubic design 244: series in cubic design 255: series with 5 x 5 mm ² cross section 288: series with 8 x 8 mm ² cross section |
| ZZ | Housing / thread: MM: metal housing (active surface: plastic) / metric thread FM: full-metal housing (active surface: stainless steel AISI 316L) / metric thread MP: metal housing (active surface: plastic) / smooth (without thread) |
| AAA | Output current / supply: 4NO: PNP transistor, NO contact 4NC: PNP transistor, NC contact 2NO: NPN transistor, NO contact 2NC: NPN transistor, NC contact 1NO: relay, NO contact / AC/DC 1NC: relay, NC contact / AC/DC 44: 2 PNP transistor switching outputs, antivalent (NO + NC) |
| BB | Special equipment: n/a: no special equipment 5F: food version 5: housing material V2A (1.4305, AISI 303) |
| CCC | Measurement range / type of installation: 1E0: typ. range limit 1.0 mm / embedded installation 1E5: typ. range limit 1.5 mm / embedded installation 2E0: typ. range limit 2.0 mm / embedded installation 3E0: typ. range limit 3.0 mm / embedded installation 4E0: typ. range limit 4.0 mm / embedded installation 5E0: typ. range limit 5.0 mm / embedded installation 6E0: typ. range limit 6.0 mm / embedded installation 8E0: typ. range limit 8.0 mm / embedded installation 10E: typ. range limit 10.0 mm / embedded installation 12E: typ. range limit 12.0 mm / embedded installation 20E: typ. range limit 20.0 mm / embedded installation 22E: typ. range limit 22.0 mm / embedded installation 2N5: typ. range limit 2.5 mm / non-embedded installation 4N0: typ. range limit 4.0 mm / non-embedded installation 8N0: typ. range limit 8.0 mm / non-embedded installation 10N: typ. range limit 10.0 mm / non-embedded installation 12N: typ. range limit 12.0 mm / non-embedded installation 15N: typ. range limit 15.0 mm / non-embedded installation 20N: typ. range limit 20.0 mm / non-embedded installation 25N: typ. range limit 25.0 mm / non-embedded installation 40N: typ. range limit 40.0 mm / non-embedded installation |

Part no.: 50111871 – IS 230MM/4NC-10E-S12 – Inductive switch

| | |
|-----|--|
| DDD | Electrical connection: n/a: cable, PVC, standard length 2000 mm S12: M12 connector, 4-pin, axial 200-S12: cable, PVC, length 200 mm with M12 connector, 4-pin, axial 200-S8.3: cable, PVC, length 200 mm with M8 connector, 3-pin, axial S8.3: M8 connector, 3-pin, axial 005-S8.3: cable, PVC, length 500 mm with M8 connector, 3-pin, axial |
|-----|--|

| |
|---|
| Note |
| A list with all available device types can be found on the Leuze electronic website at www.leuze.com . |





Notes

| |
|---|
| Observe intended use! |
| <ul style="list-style-type: none"> This product is not a safety sensor and is not intended as personnel protection. The product may only be put into operation by competent persons. Only use the product in accordance with its intended use. |





| |
|---|
| For UL applications: |
| <ul style="list-style-type: none"> For UL applications, use is only permitted in Class 2 circuits in accordance with the NEC (National Electric Code). |

Accessories

Connection technology - Connection cables

| | Part no. | Designation | Article | Description |
|---|----------|--------------------|------------------|---|
|  | 50130654 | KD U-M12-4A-P1-020 | Connection cable | Connection 1: Connector, M12, Axial, Female, A-coded, 4 -pin Connection 2: Open end Shielded: No Cable length: 2,000 mm Sheathing material: PUR |
|  | 50130657 | KD U-M12-4A-P1-050 | Connection cable | Connection 1: Connector, M12, Axial, Female, A-coded, 4 -pin Connection 2: Open end Shielded: No Cable length: 5,000 mm Sheathing material: PUR |
|  | 50130648 | KD U-M12-4A-V1-020 | Connection cable | Connection 1: Connector, M12, Axial, Female, A-coded, 4 -pin Connection 2: Open end Shielded: No Cable length: 2,000 mm Sheathing material: PVC |
|  | 50130652 | KD U-M12-4A-V1-050 | Connection cable | Connection 1: Connector, M12, Axial, Female, A-coded, 4 -pin Connection 2: Open end Shielded: No Cable length: 5,000 mm Sheathing material: PVC |



Part no.: 50111871 – IS 230MM/4NC-10E-S12 – Inductive switch

| | Part no. | Designation | Article | Description |
|--|----------|--------------------|------------------|--|
|  | 50130692 | KD U-M12-4W-P1-020 | Connection cable | Connection 1: Connector, M12, Angled, Female, A-coded, 4 -pin Connection 2: Open end Shielded: No Cable length: 2,000 mm Sheathing material: PUR |
|  | 50130694 | KD U-M12-4W-P1-050 | Connection cable | Connection 1: Connector, M12, Angled, Female, A-coded, 4 -pin Connection 2: Open end Shielded: No Cable length: 5,000 mm Sheathing material: PUR |
|  | 50130688 | KD U-M12-4W-V1-020 | Connection cable | Connection 1: Connector, M12, Angled, Female, A-coded, 4 -pin Connection 2: Open end Shielded: No Cable length: 2,000 mm Sheathing material: PVC |
|  | 50130690 | KD U-M12-4W-V1-050 | Connection cable | Connection 1: Connector, M12, Angled, Female, A-coded, 4 -pin Connection 2: Open end Shielded: No Cable length: 5,000 mm Sheathing material: PVC |

Mounting technology - Mounting brackets

| | Part no. | Designation | Article | Description |
|---|----------|-------------|------------------|--|
|  | 50113510 | BT D30M.5 | Mounting bracket | Diameter, inner: 30.2 mm Design of mounting device: Angle, L-shape Fastening, at system: Through-hole mounting Mounting bracket, at device: Screw type Type of mounting device: Rigid Material: Stainless steel |

Mounting technology - Other

| | Part no. | Designation | Article | Description |
|---|----------|-------------|---------|---|
|  | 50132730 | AC D30M-CS | Clamp | Contains: 2x M36 mounting nut Diameter, inner: 30 mm Design of mounting device: Mounting clamp Fastening, at system: Screw type, Through-hole mounting Mounting bracket, at device: insertable, Clampable with limit stop Type of mounting device: Clampable, With limit stop Material: Metal |
|  | 50111503 | MC 030K | Clamp | Diameter, inner: 30 mm Design of mounting device: Mounting clamp Fastening, at system: Through-hole mounting Mounting bracket, at device: Clampable Type of mounting device: Rigid Material: Plastic |
|  | 50111504 | MC 030K-LS | Clamp | Diameter, inner: 30 mm Design of mounting device: Mounting clamp Fastening, at system: Through-hole mounting Mounting bracket, at device: Clampable with limit stop Type of mounting device: Rigid Material: Plastic |