



Part no.: 50039069
TFI 05 1601.120
Transponder



Figure can vary

Contents

- Technical data
- Dimensioned drawings
- Accessories

Part no.: 50039069 – TFI 05 1601.120 – Transponder

Technical data

Basic data

Series	TFI
Suitable for	RFI
Chip	EM4102
Working frequency	0.125 MHz

Electrical data

Performance data

Memory access	Read only
Memory size	8 B
Memory block	1 Piece(s)
Memory block size	1 B
Storage time	100 ms

Certifications

Standards applied	ISO 15693
-------------------	-----------

Mechanical data

Design	Disc
Thickness	2.5 mm
Outer diameter	50 mm
Inner diameter	5 mm
Housing material	Plastic
Net weight	4.5 g
Type of fastening	Through-hole mounting

Environmental data

Ambient temperature, operation	-20 ... 85 °C
Ambient temperature, storage	-20 ... 200 °C

Certifications

Degree of protection	IP 67
----------------------	-------

Classification

Customs tariff number	85235200
eCl@ss 8.0	27289290
eCl@ss 9.0	27280402
ETIM 5.0	EC002996
ETIM 6.0	EC002996

Dimensioned drawings

All dimensions in millimeters

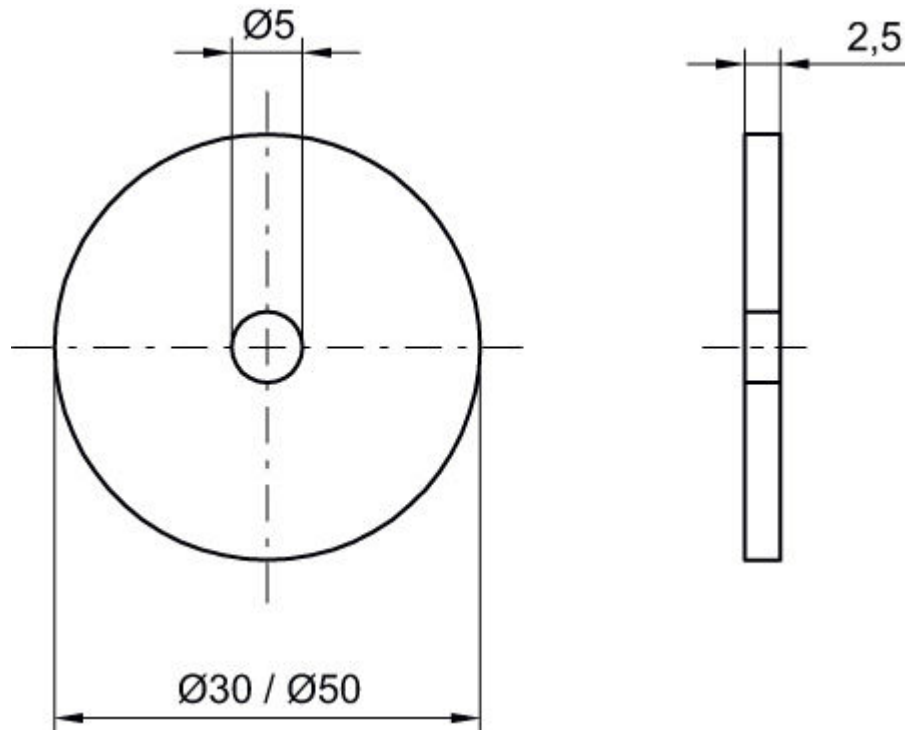

Notes

- Under certain circumstances, metal in the reading field reduces the operating range considerably.

Accessories

Mounting technology - Other

	Part no.	Designation	Article	Description
	50107103	Spacer 50 HT	Spacer	Design, housing: Hollow cylinder Inner diameter: 5 mm Housing material: Plastic, PA 66