

**Part no.: 50035865**  
**CB-D9-5000-5GF/GM**  
**Interconnection cable**

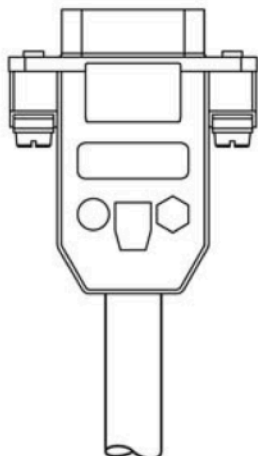
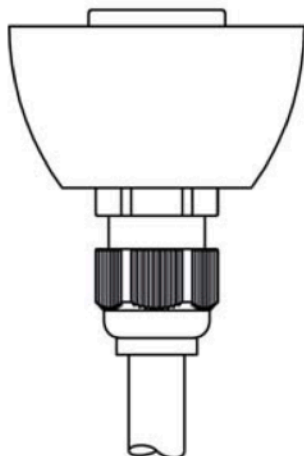

Figure can vary

## Contents

- Technical data
- Electrical connection

## Technical data

<b>Connection</b>	
<b>Connection 1</b>	
Type of connection	Sub-D
Type	Female
No. of pins	9 -pin
Design	Axial
<b>Connection 2</b>	
Type of connection	Sub-D
Type	Male
No. of pins	9 -pin
Design	Axial
<b>Cable properties</b>	
Number of conductors	5 Piece(s)
Shielded	Yes
Cable design	Interconnection cable
Cable length	5,000 mm

<b>Classification</b>	
Customs tariff number	85444290
eCl@ss 8.0	27279218
eCl@ss 9.0	27060311
ETIM 5.0	EC001855
ETIM 6.0	EC001855

## Electrical connection

<b>Connection 1</b>	
Type of connection	Sub-D
Type	Female
No. of pins	9 -pin
Design	Axial

<b>Connection 2</b>	
Type of connection	Sub-D
Type	Male
No. of pins	9 -pin
Design	Axial