



Circular connector M12 4-pin

Product characteristics

- High protection class as well as high temperature range to meet the demands of adverse industrial environments
- Circular connector for customised assembly

Technical drawing

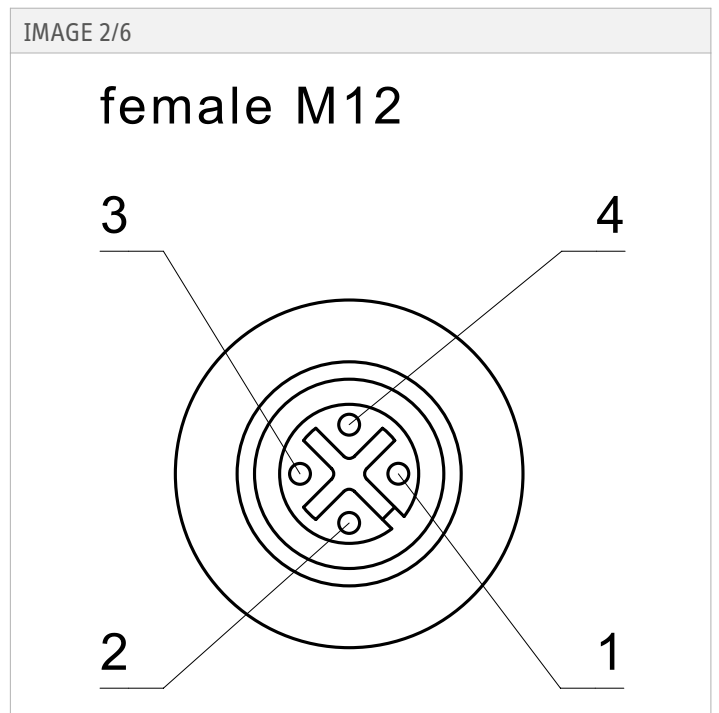
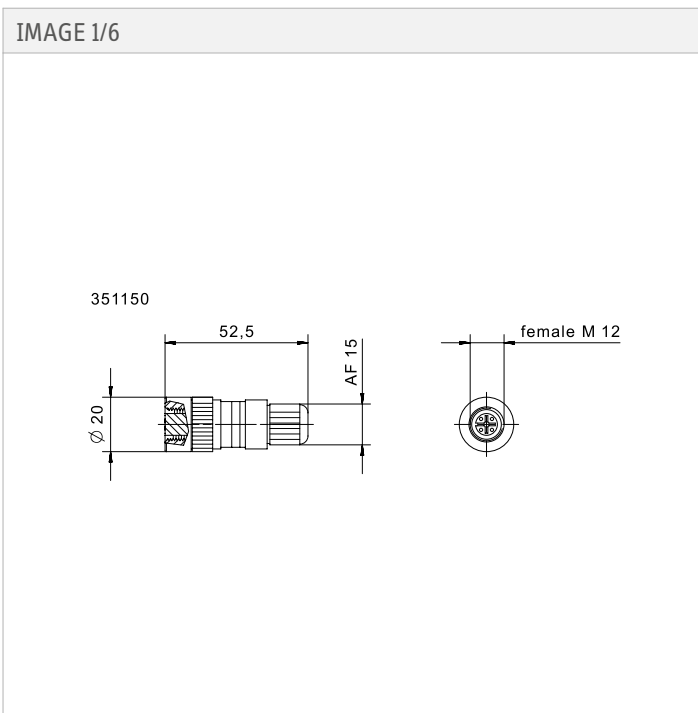

IMAGE 3/6

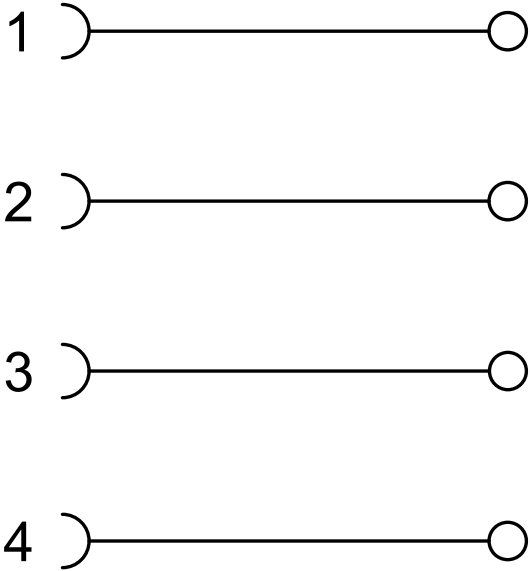

IMAGE 4/6

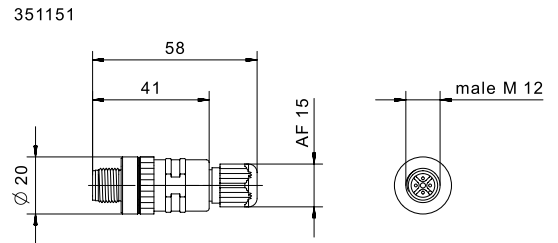

IMAGE 5/6

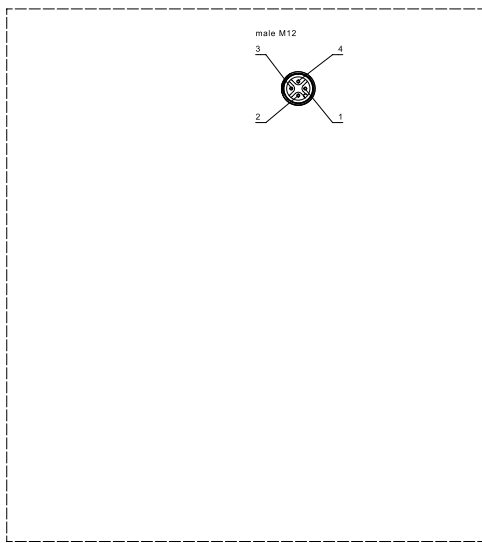
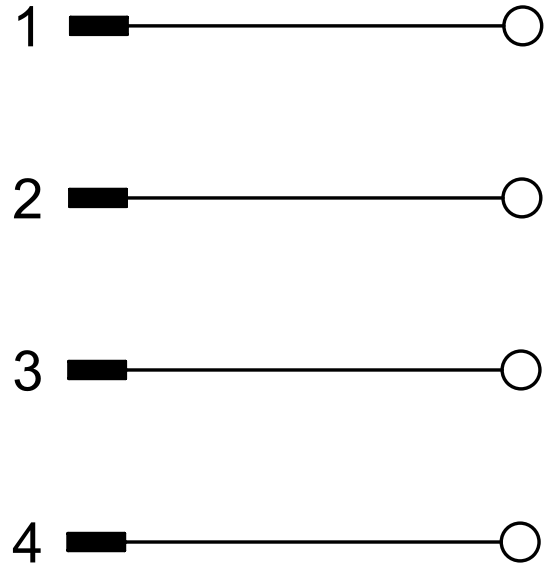



IMAGE 6/6



	Maßstab		Benennung
	Revision	E	Kupplungsdose
	Gest. Datum	29.03.19	Nummer
	Gepüft	pr1mi	Cat_351151

Attribute	351150	351151
Pollution degree	3	

Electrical data

Attribute	351150	351151
Max. switching current per contact	4 A	
Rated impulse withstand voltage (Uimp)	2500 V	
Operating voltage max.	240 V DC	
Operating voltage max.	240 V AC	

Material information

Attribute	351150	351151
Nut material	CuZi vernickelt	
Overmould material	PA	

Environmental conditions

Attribute	351150	351151
Operating temperature min.	-40 °C	
Max. operating temperature	85 °C	
Min. storage temperature	-40 °C	
Max. storage temperature	85 °C	

Installation

Attribute	351150	351151
Torque for nuts	0,5 N m	

Connection

Attribute	351150	351151
Connector type	M12 Buchse gerade	M12 Stecker gerade
Cable diameter	3 - 6,5 mm	
Number of pins	4	
Connection type	Schraubverschluss	
Min. connection cross section	0.14 mm ²	
Max. connection cross section	0.75 mm ²	

Approvals

Attribute	351150	351151
Certified in accordance with	UL 2238/CSA22.2	