



Online Data Sheet

Encoder WDGA 36A SSI

www.wachendorff-automation.com/wdga36assi

Wachendorff Automation

... systems and encoders

- Complete systems
- Industrial rugged encoders to suit your application
- Standard range and customer versions
- Maximum permissible loads
- 48-hour express production
- Made in Germany
- Worldwide distributor network

Encoder WDGA 36A absolute SSI magnetic, with EnDra®-Technology



EnDra®
Technologie

SSI
Synchronous Serial Interface

- EnDra® multiturn technology: maintenance-free and environmentally friendly
- SSI, gray or binary
- Single-turn/Multi-turn (16 bit / 43 bit)
- Forward-looking technology with 32 bit processor
- 2-colour-LED as indicator for operating condition

www.wachendorff-automation.com/wdga36assi

Mechanical Data	
Housing	
Flange	synchro flange
Flange material	aluminum
Housing cap	steel case chrome-plated, magnetic shielding
Housing	Ø 36 mm
Shaft(s)	
Shaft material	stainless steel
Starting torque	approx. 0.3 Ncm at ambient temperature
Shaft 1	
Shaft	Ø 6 mm
Shaft length	L: 11.5 mm
Max. Permissible shaft loading radial	80 N
Max. Permissible shaft loading axial	50 N
Shaft 2	
Shaft	Ø 8 mm
Shaft length	L: 18 mm
Max. Permissible shaft loading radial	50 N
Max. Permissible shaft loading axial	50 N
Bearings	
Bearings type	2 precision ball bearings
Nominal service life	1.4 x 10 ⁸ revs. at 100 % rated shaft load 2 x 10 ⁹ revs. at 40 % rated shaft load 1.7 x 10 ¹⁰ revs. at 20 % rated shaft load
Max. operating speed	12000 rpm
Machinery Directive: basic data safety integrity level	
MTTF _d	1000 a
Mission time (TM)	20 a
Nominal service life (L10h)	1.7 x 10 ¹⁰ revs. at 20 % rated shaft load and 12000 rpm
Diagnostic coverage (DC)	0 %
Electrical Data	
Power supply/Current consumption	10 VDC up to 32 VDC: typ. 50 mA
Power consumption	max. 0.5 W
Power supply/Current consumption	4,75 VDC up to 5,5 VDC: typ. 80 mA
Power consumption	max. 0.44 W

Sensor data	
Single-turn technology	innovative hall sensor technology
Single-turn resolution	up to 65,536 steps/360° (16 bit)
Single-turn accuracy	< ±0.35°
Single-turn repeat accuracy	< ±0.20°
Internal cycle time	600 µs
Multi-turn technology	patented EnDra® technology no battery, no gear.
Multi-turn resolution	up to 43 bit.
Environmental data	
Environmental data:	
ESD (DIN EN 61000-4-2):	8 kV
Burst (DIN EN 61000-4-4):	2 kV
includes EMC:	DIN EN 61000-6-2 DIN EN 61000-6-3
Vibration: (DIN EN 60068-2-6)	50 m/s ² (10 Hz up to 2000 Hz)
Shock: (DIN EN 60068-2-27)	1000 m/s ² (6 ms)
Design:	according DIN VDE 0160
Turn on time:	<1,5 s
Interface	
Interface:	SSI
Clock input:	via opto-coupler
Clock frequency:	100 kHz up to 500 kHz, up to 2 MHz on request
Data output:	RS485/RS422 compatible
Output code:	gray or binary
SSI output:	Angular-/position value
Parity bit:	optional (even/odd)
Error bit:	optional
Turn on time:	<1,5 s
Configuration inputs	DIR = GND -> cw DIR = +UB -> ccw
Positive direction of counting: (View on shaft)	
Set to zero:	Set: Preset = +UB for 2 s Deactivate: Preset = GND
LED-behaviour:	
At Start / while booting:	- red gleam (< 2.3 s)
Malfunction:	- constant red gleam (> 2.3 s)

Normal function: - constant green gleam

No supply: - no gleam

Transmission protocol SSI Single transmission:

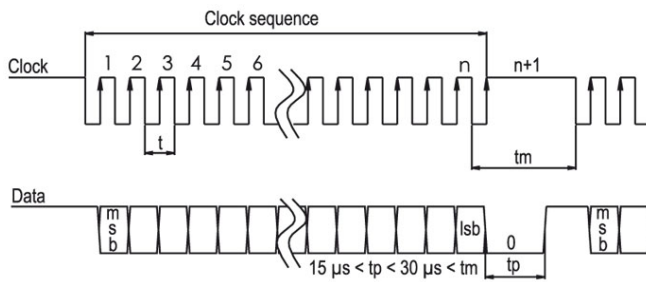

Transmission protocol SSI Multipath transmission:

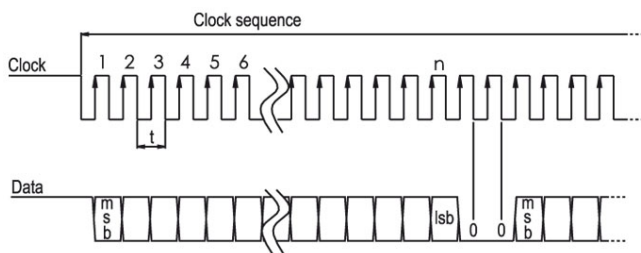

General Data

Weight	approx. 112 g
Connections	cable or connector outlet
Protection rating (EN 60529)	Housing: IP65, IP67; shaft sealed: IP65; cable outlet K1: IP40, K6: IP20
Operating temperature	-40 °C up to +85 °C
Storage temperature	-40 °C up to +100 °C

More Information

General technical data and safety instructions
<http://www.wachendorff-automation.com/gtd>

Options
<http://www.wachendorff-automation.com/acc>

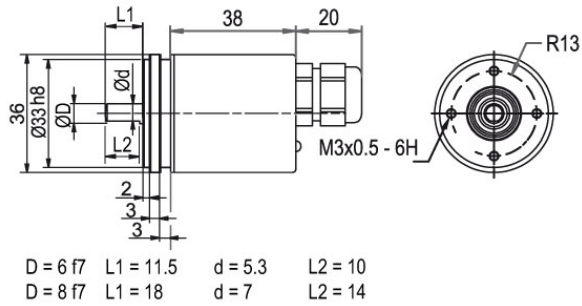
Cable connection, L2 with 2 m cable

Description

L2 axial, shield connected to encoder housing

Assignments	
	L2
GND	WH
(+) Vcc	BN
SSI CLK+	GN
SSI CLK-	YE
SSI DATA+	GY
SSI DATA-	PK
PRESET	BU
DIR	RD
Shield	housing

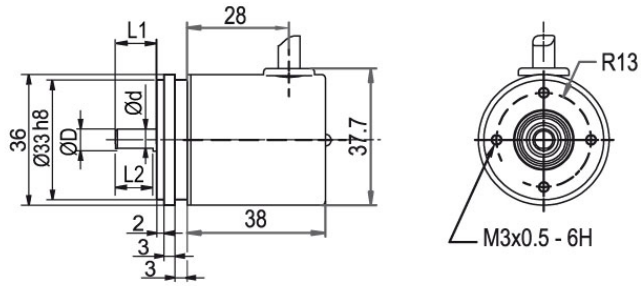
Cable connection, K1 with 2 m cable (IP40)



D = 6 f7 L1 = 11.5 d = 5.3 L2 = 10
 D = 8 f7 L1 = 18 d = 7 L2 = 14

Description

K1 radial, shield not connected

Assignments	
	K1
GND	WH
(+) Vcc	BN
SSI CLK+	GN
SSI CLK-	YE
SSI DATA+	GY
SSI DATA-	PK
PRESET	BU
DIR	RD
Shield	housing n. c.

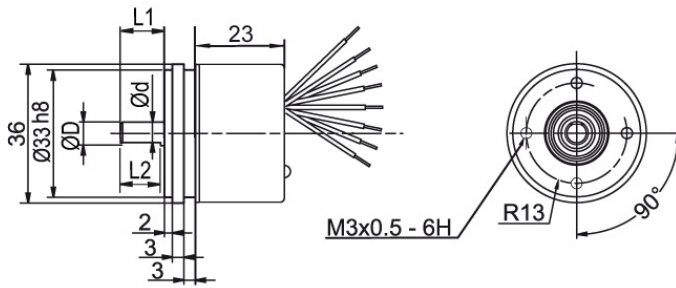
Cable connection, K6 with 8 cm loose wires, IP20

D = 6 f7 L1 = 11.5 d = 5.3 L2 = 10
 D = 8 f7 L1 = 18 d = 7 L2 = 14

Description

K6 axial, shield not connected

Assignments	
	K6
GND	WH
(+) Vcc	BN
SSI CLK+	GN
SSI CLK-	YE
SSI DATA+	GY
SSI DATA-	PK
PRESET	BU
DIR	RD
Shield	housing n. c.

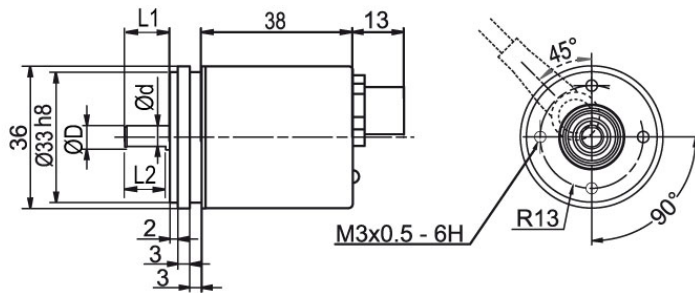
Connector, M12x1, CB8, axial, 8-pin

D = 6 f7 L1 = 11.5 d = 5.3 L2 = 10
 D = 8 f7 L1 = 18 d = 7 L2 = 14

Description

CB8 axial, 8-pin, shield connected to encoder housing

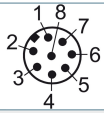
Assignments	
	CB8 
GND	1
(+) Vcc	2
SSI CLK+	3
SSI CLK-	4
SSI DATA+	5
SSI DATA-	6
PRESET	7
DIR	8
Shield	housing

Example Order No.	Type	Your encoder
WDGA 36A	WDGA 36A	WDGA 36A
	Shaft	Order key
06	∅ 6 mm	06
	∅ 8 mm	08
	Single-turn Resolution	Order key
12	Single-turn resolution 1 bit up to 16 bit: (e. G. 12 bit)	12
	Multi-turn Resolution	Order key
12	Multi-turn up to 43 bit (e. G. 12 bit) No Multi-turn = 00	12
	Data protocol	Order key
SI	SSI	SI
	Software	Order key
A	up to date release	A
	Code	Order key
B	binary	B
	gray	G
	Power supply	Order key
0	10 V up to 32 V (standard)	0
	4.75 V up to 5.5 V	1
	Galvanic isolation	Order key
1	yes	1
	Electrical connections	Order key
CB8	Cable:	
	axial, shield connected to encoder housing, with 2 m cable, IP67	L2
	radial, shield not connected, with 2 m cable, IP40	K1
	axial, shield not connected, IP20, with 8 cm loose wires	K6
	Connector:	
sensor-connector, M12x1, 8-pin, axial, IP67, shield connected to encoder housing	CB8	

Example Order No.	WDGA 36A	06	12	12	SI	A	B	0	1	CB8
--------------------------	----------	----	----	----	----	---	---	---	---	-----

WDGA 36A										Example Order No.
----------	--	--	--	--	--	--	--	--	--	--------------------------



For further information please contact our local distributor.
Here you find a list of our distributors worldwide.
<https://www.wachendorff-automation.com/>



Wachendorff Automation GmbH & Co. KG
Industriestrasse 7 • 65366 Geisenheim
Germany

Phone: +49 67 22 / 99 65 25
Fax: +49 67 22 / 99 65 70
E-Mail: wdg@wachendorff.de
www.wachendorff-automation.de

